

WINNING TRENCH WARFARE:
BATTLEFIELD INTELLIGENCE IN THE CANADIAN CORPS, 1914 - 1918

by

Dan Richard Jenkins, B.A., M.A.

A thesis submitted to the Faculty of Graduate Studies and Research
in partial fulfilment of the requirements for the
degree of Doctor of Philosophy

Department of History
Carleton University
Ottawa, Canada
1999

© Copyright, 1999
Dan Jenkins



National Library
of Canada

Acquisitions and
Bibliographic Services

395 Wellington Street
Ottawa ON K1A 0N4
Canada

Bibliothèque nationale
du Canada

Acquisitions et
services bibliographiques

395, rue Wellington
Ottawa ON K1A 0N4
Canada

Your file *Votre référence*

Our file *Notre référence*

The author has granted a non-exclusive licence allowing the National Library of Canada to reproduce, loan, distribute or sell copies of this thesis in microform, paper or electronic formats.

The author retains ownership of the copyright in this thesis. Neither the thesis nor substantial extracts from it may be printed or otherwise reproduced without the author's permission.

L'auteur a accordé une licence non exclusive permettant à la Bibliothèque nationale du Canada de reproduire, prêter, distribuer ou vendre des copies de cette thèse sous la forme de microfiche/film, de reproduction sur papier ou sur format électronique.

L'auteur conserve la propriété du droit d'auteur qui protège cette thèse. Ni la thèse ni des extraits substantiels de celle-ci ne doivent être imprimés ou autrement reproduits sans son autorisation.

0-612-57601-9

Canada

ABSTRACT

This study shows the importance of combat intelligence work to the success of Canadian Corps operations. To do this, the evolution of the intelligence service is described, along with those significant events that shaped and spawned this transition. The intelligence service grew from an understaffed and under appreciated component of staff work into one comprising thousands of members. Almost from the moment the Canadians arrived at the front they began improving their intelligence system. But it was the battles of 1915: Second Ypres, Festubert and Givenchy -- that pushed through the first major changes. Command confusion, ignorance, and loss of control marked Second Ypres and Festubert. On these occasions, the under trained Canadians met disciplined Germans, and paid a bloody price. At Givenchy the Canadians fared better thanks to more detailed planning. From these early experiences an enhanced appreciation for intelligence work emerged, along with an entirely new intelligence organization. From 1915, the Canadians became aggressive intelligence gatherers, collecting and analyzing every possible scrap of information before launching assaults. As tactics, technology and fire-power improved, so too did the intelligence organization, expanding to meet the altered circumstances. In doing so it enjoyed great success, compiling a tremendous amount of intelligence for commanders and planners. Operational plans became so detailed and complex that battlefield confusion, luck, and chance were reduced, as prior calculation and mathematical precision helped commanders regain some control over events. Once operations opened up in 1918, the Canadian

Corps adjusted its intelligence system to meet the changing tactical environment, and the need for increased tactical and command flexibility. The intelligence service, however, was able to adapt, and so continued to grease the wheels of command by providing an abundance of information to planners. This helped the corps come to grips with its surroundings, allowing it to maintain pressure on the enemy. While intelligence work was not the only reason for the corps' battlefield success, it was a principal element that cannot be ignored.

ACKNOWLEDGEMENTS

A number of people have given me their time and assistance, and I owe them a debt of thanks. They have helped make this a far better history than it would have been otherwise, and are certainly not to blame for any errors that may remain. My thesis director, Professor Emeritus Sydney Wise, supported my idea and helped keep me focused. His comments, advice and encouragement always inspired me to keep plodding away. Likewise, comments made on drafts of some of my early chapters by Dr. Roger Sarty of the Canadian War Museum, and Professor John Ferris of the University of Calgary, kept me on the straight and narrow. Dr. Ferris also provided me with copies of some useful primary source material. Dr. Peter Jackson, formerly of Carleton University, but now living and teaching in Wales, also offered some valuable encouragement and advice early on. I also want to thank the staff of Carleton University's inter-library loans department; I had them searching all over North America and England for material for me. It was a rare occurrence when they could not locate my request. My thanks too, to the staff of the National Archives of Canada, they were always happy to assist me. Finally, I thank my family. Their support and encouragement helped me persevere. My thanks to all.

Dan Jenkins

Spring 1999

TABLE OF CONTENTS

	page
Acceptance Form.....	ii
Abstract.....	iii
Acknowledgements.....	v
Table of Contents.....	vi
List of Tables.....	vii
List of Figures.....	viii
List of Appendices.....	ix
Chapter One. Introduction: The Intelligence Problem.....	1
Chapter Two. Expectations.....	29
Chapter Three. Early Intelligence Gathering.....	57
Chapter Four. Intelligence Awakening: 1915.....	94
Chapter Five. Emerging Professionalism: August 1915 - May 1916.....	125
Chapter Six. St. Eloi to Mount Sorrel: April - June 1916.....	168
Chapter Seven. The Somme: August - November 1916	201
Chapter Eight. Interlude: Winter 1916 - 1917	237
Chapter Nine. Vimy Ridge and Hill 70: April - August 1917	263
Chapter Ten. Passchendaele: October - November 1917	302
Chapter Eleven. The Emergence of Open Warfare:	
Spring and Summer 1918	328
Chapter Twelve. The 100 Days: August 8 to November 11, 1918	356
A Retrospect	397
Bibliography.....	405

LIST OF TABLES

	page
Table 3.1. Visibility and Altitudes.....	72
Table 5.1. Battery Intelligence Report.....	166
Table 11.1. Canadian Intelligence Corps (France).....	354

LIST OF FIGURES

	page
Figure 2.1. Prewar Intelligence Gathering During an Advance and in Close Proximity to an Enemy Force	33
Figure 2.2. Methods of Obtaining and Transmitting Information During the 1911 Tactical Exercise.....	44
Figure 2.3. Brigade Intelligence Organization	53
Figure 3.1. Front Line Combat Intelligence Sources in the 1st Canadian Division, 1915	60
Figure 3.2. Battalion Intelligence Gathering and Security Screen as Practiced by the 7th Battalion, March 1916	89
Figure 4.1. The Trench Raid.....	123
Figure 5.1. Intelligence in the Canadian Corps, May 1916	154
Figure 8.1. Counter Battery Office Intelligence, 1917 - 1918	255
Figure 9.1. 2nd Brigade's Communication Layout at Hill 70	293
Figure 11.1 1st Canadian Division Attack On Machine Gun Nest	335
Figure 11.2. Counter Mortar Intelligence	338
Figure 12.1. 12th Brigade's Moving Observation Post in an Advance	368

LIST OF APPENDICES

	page
Appendix One: Senior Corps Intelligence Officers, GSO2(I)s	404

CHAPTER ONE

INTRODUCTION: THE INTELLIGENCE PROBLEM

The history of the First World War is still being written, with each year witnessing new publications that add to our understanding of the trench deadlock on the Western Front and the ultimate Allied victory. These studies have analyzed tactics, leadership, specific battles and the impact that new technologies had on the conduct of the war. However, one aspect of the First World War that is invariably overlooked or minimized is combat intelligence. In many accounts of the war it lies concealed somewhere in the background, its importance alluded to, sometimes openly discussed, but never fully developed. Often, there is little or no attempt to explain where intelligence came from, who collected it, or to what use it was put, even though intelligence thoroughly permeated all aspects of operational planning and, indeed, all First World War combat. Sometimes it seems that information of importance to commanders just magically appears -- the location of German machine guns, for example. This study attempts to correct some of the imbalance by analyzing the role that combat intelligence played in the extraordinary battlefield success of the Canadian Corps and by revealing how the intelligence service was organized and operated on a day-to-day basis. What we will find is that the Canadian Corps' elite status owed a great deal to its successful collection and application of battlefield intelligence.

Intelligence is information processed into usable form. There are various types of intelligence: political, industrial, economic, technical and military, to name a few. Intelligence can be of a strategic nature or of tactical importance, and it can

be gathered by both covert and overt means. In all cases the best results stem from information that is both timely and accurate. This study focuses on military intelligence at the battlefield level; that is, on tactical and operational intelligence. Strategic intelligence, except insofar as it impinges upon operational and tactical concerns, is not discussed in this study, as the Canadian Corps was a subordinate formation within the larger British Expeditionary Force (BEF) and not responsible for strategic intelligence. The corps, in other words, determined what the conditions were like in its own area of operations. It was concerned with questions such as: What are the current German troop dispositions? What German troops lay opposite the corps? Where are the German gun emplacements, machine-gun nests and trench mortars? What is the condition of the German wire? What activity is occurring immediately beyond the front line trench? These and similar questions, along with some dabbling in counter espionage, were the main concerns of Canadian Corps intelligence.

One of the difficulties facing a researcher studying the influence of combat intelligence on the outcome of an operation is in trying to measure the impact of specific pieces of information on the overall event. Certainly the old adage that knowledge equals power holds true, but what knowledge, and how powerful was its effect? How can we measure the degree to which intelligence made a difference? In some cases the potential of timely intelligence is obvious, as was the case during the American Civil War of Major-General George B. McClellan, commander of the Union Army of the Potomac, being handed a document recovered by one of his reconnaissance parties that outlined the Confederate Army of Northern Virginia's strategic intentions before the Battle of Antietam. This document told McClellan that the Confederate army's commander, General Robert E. Lee, had divided his army into easily digestible portions. A previously timid McClellan found renewed energy and steeled nerves. Unfortunately for the Union, McClellan failed to

destroy Lee's army. His initial burst of energy ultimately gave way to his true indecisive and overly cautious character, which cost him and his army an enormous opportunity, and proves that intelligence by itself is not decisive. Much depends on how it is utilized. On the Western Front during the First World War, such intelligence coups were not common. More often than not, armies gained information on the enemy in bits and pieces over extended periods of time. A single patrol report, for instance, might state that a water filled ditch eight feet wide had been found near the enemy wire at a certain map reference. By itself this information may be of minor consequence, but when viewed alongside other such tidbits it could prove of enormous importance.

In the Canadian Corps we can ascertain something of the value placed on intelligence work by field officers by following the development, evolution and use made of the intelligence organization, and by recovering what contemporaries had to say about the value of intelligence to their operations. The Canadian intelligence organization evolved from an understaffed, under trained, and underutilized force into a highly competent and professional body capable of gathering the most detailed information on enemy positions for commanders with an unquenchable thirst for knowledge. The amount of detail collected before any engagement bears witness to the value assigned to intelligence, as the intelligence organization tracked down for destruction every possible machine gun location, strong point, observation post, and gun emplacement. Contemporary commanders praised the intelligence received even before the intelligence service reached full maturity in 1918, as it helped them win battles. This is how we know that combat intelligence played an enormously important role during the Great War.

However, there is more than just the timely and wise use of combat intelligence that makes for a successful operation. A wide array of ingredients are at play: the importance of terrain, weather, personality, tactics and strategic

considerations all play their part. To claim that this or that piece of information made the difference seems contemptuous of the entire mix that formed the whole. Brigadier-General David Henderson, the prewar British Army's preeminent authority on tactical intelligence, and the first commander of the Royal Flying Corps, had this to say about gauging the value of information:

The value of the [intelligence] advantage cannot be assessed accurately, even for historical cases; the difficulty and complexity of the art of war is due, in great measure, to the number and varying importance of the different factors which together produce success. The strategical or tactical skill of the commanders, the valour, discipline, and endurance of the troops, organisation, numbers, weapons, luck: these also must be considered...Their relative importance can only be a matter of opinion...Yet so indirect is the influence of information, so much is its value overshadowed by the evident effect of strategical and tactical combinations, that students of war sometimes forget that such combinations are entirely dependent on information; and consider historical problems without regard to the amount of information available on either side, still less to the methods by which the information is acquired. Successful generals, too, are occasionally inclined to minimise the assistance they have received from good information, fearing that if they admit advantage in this respect, the influence of their own skill, or intuition, or genius, on the result, may be discounted; it is only the unsuccessful general who emphasises the importance of the information which he did not get, and nobody pays much attention to the excuses of the man who failed.¹

For these reasons Henderson believed that the importance of information on operations was sometimes forgotten, and that peacetime armies often neglected the study of its acquisition and use.

There is a plethora of secondary source material dealing with Canada in the First World War.² However, unlike most of the major belligerents, Canada did not complete a comprehensive official history of its military contributions immediately following the close of hostilities. It has rested largely with Sir James Edmonds'

¹ David Henderson, *The Art of Reconnaissance*, 3rd. ed. (London: John Murray, 1914), 1-3.

² Full a list of works consulted see the Bibliography beginning on page 405.

various volumes of British official history, written over a thirty year time span following the war's end, to place the Canadian Corps' battlefield exploits into any kind of military context. Of course, Edmonds' concern did not lie solely with the actions of the Canadian Corps, as the Canadian Corps was just one of many British corps in operation by 1918. As for intelligence matters, Edmonds did not develop it as one of his themes.

It was not until 1938 that Fortescue Duguid's *Official History of the Canadian Forces in the Great War, 1914 - 1919* appeared, and it remains incomplete. Only volume one, covering the period August 1914 to September 1915, plus one volume of appendices, was finished. Most of the war is missing from Duguid's account, including the three years that the Canadian Corps existed. Coverage of the intelligence service is largely absent, although reference to the importance of intelligence is not neglected.

A second official history, G. W. L. Nicholson's *Canadian Expeditionary Force 1914 - 1919* (1962), covers the entire war in a single volume of 536 pages (not including notes, appendices and indices). Considering the scale of Canada's involvement, considerations of space forced Nicholson to limit his inquiry. As with Duguid's history, Nicholson does mention the value of intelligence to those operations where it played an obvious role. However, the routine activities of the intelligence service are not considered, nor is its role in Canadian battlefield successes fully analyzed.

In addition to Duguid's and Nicholson's official histories, there is S. F. Wise's *Canadian Airmen and the First World War* (1980). This is volume one of the official history of the Royal Canadian Air Force. Aerial reconnaissance was intimately connected with intelligence, being one of the most important methods for learning about conditions in and behind German lines. Wise's book sheds valuable light on liaison and cooperation between the Royal Flying Corps (Royal Air Force

after April 1918) and ground troops, and about the importance of aerial reconnaissance in the success of British and Canadian arms. Wise's book, however, is not preoccupied with the actions of the Canadian Corps and its attached squadron(s), but with Canadian airmen wherever they served.

The failure to tell in detail Canada's official story has left a historical vacuum. Works published in the 1920s and 1930s, although often highly informative, were produced by men too close in time to the events they were discussing. Theirs are not dispassionate histories. In many accounts the Canadian Corps and its members did no wrong; failings are due to those outside the corps, or were glossed over. Most scholarly research on the corps' activities is of recent origin; and to date there has been little effort to evaluate the effect of the Canadian combat intelligence gathering system on Canadian operations.

There are several excellent general histories available dealing with the corps, its officers, and its evolution. They include: John Swettenham's *To Seize the Victory: The Canadian Corps in World War I* (1965); D.J. Goodspeed's *The Road Past Vimy* (1969); and any number of books by Daniel Dancocks, such as, *Legacy of Valour, The Canadians at Passchendaele* (1986); *Spearhead to Victory* (1987), and *Welcome to Flanders Fields* (1989). In Nicholson's *The Gunners of Canada* (1967), the importance of artillery intelligence is given coverage but the intelligence needs of the infantry are underdeveloped. Stephen Harris' *Canadian Brass: The Making of a Professional Army 1860 - 1939* (1988), Bill Rawling's *Surviving Trench Warfare: Technology and the Canadian Corps, 1914 - 1918* (1992), and Shane Schreiber's *Shock Army of the British Empire: The Canadian Corps in the Last 100 Days of the Great War* (1997), go beyond the simple recounting of events. Harris explains the rise of Canadian military professionalism and its impact on military conduct. Although Harris does not deal specifically with combat intelligence, the evolution in professionalism that he describes is readily apparent in

the Canadian approach to tactical intelligence. Rawling explains how the corps' success was a direct result of its ability to master and apply modern technology in innovative ways at the tactical level. He touches upon intelligence, but it is not his main concern, so we do not always see it in operation. Schreiber's informative book, meanwhile, looks at Canadian offensive tactics, organization and command arrangements during the 100 Days Campaign (August - November 1918) in order to explain why the Canadian Corps was the ideal instrument for spearheading the British Army's final offensive. Intelligence is not developed as a major theme, although it is clear from Schreiber's account that Canadian set-piece assault plans were saturated with intelligence, and helped commanders orchestrate the all-arms battle. The same is true of Ian Brown's valuable article "Not Glamorous, But Effective: The Canadian Corps and the Set-Piece Attack, 1917 - 1918," *The Journal of Military History*, 58.3 (July 1994), 421 - 444. Brown discusses the set-piece attack at the operational level, and shows how it was an effective war winning procedure. In all of these histories intelligence is referred to but, as it is not the principle focus of study, in only a cursory fashion. These works, however, help to build the context in which combat intelligence played itself out.

Unit histories and biographies also help unmask the value of combat intelligence. By focusing on the accomplishments of specific individuals and commands these works often provide clues as to how intelligence worked in the field as opposed to how it worked in theory. Unit histories and biographies develop the human side of war, and recount the exploits of individuals, thus breathing life into the cold hard facts. Swettenham's biography of Andrew McNaughton (*McNaughton*, 1968), who in the First World War emerged as Canada's premier artillery officer, is one such case. It offers a good overview of McNaughton's contribution to the development of artillery intelligence, and covers the value of artillery intelligence in general. Hugh Urquhart's *Arthur Currie: The*

Biography of a Great Canadian (1950), Dancocks' *Sir Arthur Currie: A Biography* (1985), and A.M.J. Hyatt's *General Sir Arthur Currie: A Military Biography* (1987), are valuable for their insight into the mind of General Currie, the corps commander during the last year and a half of the war, as he developed his martial skill through his struggles with trench warfare. These biographies also speak to the force of Currie's personality on the development of the Canadian Corps and its concern with detail, and thus to intelligence as well. The same is true of Jeffery Williams' *Byng of Vimy, General and Governor General* (1983). Lieutenant-General Sir Julian Byng was the corps commander before Currie and, like Currie, was a meticulous planner, and an important influence on the corps' development. But again these books, due to the nature of their subject, only deal with intelligence in a limited way.

Other works, and there are far too many to name here, are important for their contribution to our understanding of specific engagements. Battle studies can reveal how important intelligence was to a given encounter but, again, as intelligence is not normally the focus of such works, it is not always clear how the intelligence came about. In other words, conclusions reached by commanders who studied the available intelligence are given, but the enormous effort that went into acquiring the information in the first place is often lost to the reader.

There are a number of books and articles that concentrate on British and Canadian tactical doctrine and development. Rawling's *Surviving Trench Warfare*, and Schreiber's *Shock Army* have been mentioned, and are must reads for their insights into the offensive capabilities of the Canadian Corps. Works by Tim Travers, such as his *The Killing Ground* (1987), D.S. Graham's and S. Bidwell's *Firepower: British Army Weapons and Theories of War 1904 - 1945* (1982), and Paddy Griffith's *Battle Tactics of the Western Front: the British Army's Art of Attack 1916 - 1918* (1994), represent some of the latest scholarship regarding the

British approach to combat. They help set the tactical stage on which intelligence operated by analyzing British military thinking both before and during the war. They also explore contemporary attitudes towards battle which, in turn, influenced the stature and development of battlefield intelligence organizations.

Since none of the above works delve deeply into the nitty-gritty of intelligence gathering in the field, we are often left guessing as to the importance of intelligence on the outcome of given operations. One regularly reads, for example, that the Canadian Corps faced certain German regiments that were at half strength, tired, suffering from low morale, or awaiting reinforcement. We are *not* always told if these details were known at the time, or if this is historical hindsight at work. At other times we are told that Canadian planners knew the locations of German artillery batteries and machine-gun nests, but how did the Canadians learn of these details? The Germans, after all, were not an enemy who intentionally advertised their strengths and weaknesses. The corps had to gather, interpret, sort, and incorporate this intelligence into its planning, all in the face of a hostile enemy. The fog of war was real, and the Canadian Corps had to navigate through it as best it could.

Shedding light on how the fog was dissipated are several works that deal specifically with intelligence. Most are of the cloak and dagger variety with little to say about intelligence on the field of battle; however, those that do discuss combat intelligence are revealing, not necessarily for what they have to say about Canadian combat intelligence, but for their coverage of British developments and attitudes; factors that affected the Canadian Corps' own development. Michael Occleshaw's, *Armour Against Fate: British Military Intelligence in the First World War* (1989), adds to our understanding of combat intelligence during the war. Occleshaw, however, does not focus solely on intelligence developments on the Western Front. Instead, he includes a study of intelligence developments in Africa and the Middle

East, where entirely different intelligence environments existed. Furthermore, half his book is devoted to case studies involving international espionage -- important studies in their own right, but of little value to a study of the development of combat intelligence in the Canadian Corps. John Ferris' studies of signals intelligence are excellent for that particular line of intelligence work; however, the responsibility for the collation and interpretation of signals intelligence resided, for the most part, at commands higher than corps. Christopher Andrew's *Secret Service: The Making of the British Intelligence Community* (1984), and T.G. Fergusson's, *British Military Intelligence, 1870 - 1914: The Development of a Modern Intelligence Organization* (1984), and Michael Handel's, *Intelligence and Military Operations* (1990), and *War, Strategy and Intelligence* (1989), among a number of others, outline British ideas and intelligence practices in the years before 1914. As the Canadian Militia mirrored the form and substance of British military methods, these works help place the Canadian approach to battlefield intelligence into the larger imperial context.

Specific aspects of First World War battlefield intelligence are reviewed in a number of articles and major works written by participants in the war. Andrew McNaughton's post-war writings provide insight into the state of the art of artillery intelligence as it existed in 1918, while John Innes' book, *Flash Spotters and Sound Rangers* (1935), offers excellent coverage of the evolution of flash spotting and sound ranging as techniques for locating German artillery. H. Hesketh-Prichard's, *Sniping in France, How the British Army Won the Sniping War in the Trenches*, discusses the importance of sniping to the intelligence effort, while articles by C.N.F. Broad, and H. Winterbotham discuss artillery and survey work, and so describe how intelligence related to those two topics. All of these accounts help us understand the growth and change within the various combat intelligence gathering bodies. Being specialized works, however, they cannot, and do not try

to, cover the entire spectrum of the intelligence war effort. With the exception of McNaughton's work, the Canadian Corps' experiences are generally not referred to.

There are two worthy books that deal entirely with Canadian intelligence matters. Major S.R. Elliot's *Scarlet to Green, A History of Intelligence in the Canadian Army 1903 - 1963* (1981), is one. However, since Elliot's book covers such a large period of time, his analysis of First World War intelligence receives only one short chapter. He presents a good, but brief, overview of the intelligence contribution to winning the war, but he does not show in any detailed way how the intelligence service grew and changed during the war. Neither does he cover the intelligence needs of the artillery. Only J. E. Hahn's, *The Intelligence Service Within The Canadian Corps, 1914 - 1918* (1930), deals directly with the nuts and bolts of tactical intelligence gathering. Hahn's book reflects his experiences as an intelligence officer in the 4th Canadian Division, and is an excellent place to begin any research into the corps' intelligence service. He explains, in an uncritical manner, some of the corps' routine intelligence functions, organization and equipment requirements. He also presents the intelligence service in a vacuum, making little effort to analyze intelligence operations in conjunction with other operational arms. He omits for the most part any discussion of artillery intelligence, even though from late 1916 onwards combat intelligence focused largely on the needs of the artillery. He sticks mainly to infantry intelligence (although he does offer a brief discussion of aerial intelligence), showing how the intelligence service operated in divisions and lower commands. The evolution of combat intelligence within the corps is not covered.

As this is the first modern study of Canadian combat intelligence during the First World War, primary sources form the backbone of the analysis that follows. The National Archives of Canada holds the bulk of the primary documents on

Canada's wartime contribution. By sifting through unit and formation documents and through the personal papers of men who served, one can retrieve a great deal about intelligence matters. Fortunately, a considerable corpus of such documentation survives. A list of material referred to is too ponderous to reproduce here, but references are assiduously noted in the text.

What the primary and secondary sources reveal is that combat intelligence mattered, and was essential for winning the war. The detail contained in operational orders, the desire to know everything about the German position from no man's land to beyond the deepest German defensive line, the increased complexity and specialization of intelligence organizations, and the search for new and improved techniques for collecting information, all attest to the value ultimately placed on the work of intelligence gatherers. By early 1917, the Canadians excelled at intelligence work; 1918 saw further refinements. Their arrival at that state of proficiency was a long and at times costly process. But the victories of 1917 and 1918 would have been impossible had the practices and techniques of combat intelligence gathering remained at their prewar level of development. Intelligence gathering underwent a sea change during the First World War as combatants adapted their prewar methods -- designed for open warfare -- to siege conditions. Gone, for instance, were the days of the wide ranging cavalry reconnaissance sweep. There were no J.E.B. Stuarts, of American Civil War fame, riding around an entire army during the Great War, nor was there an opportunity for such a ride, especially once the lines solidified into well constructed entrenchments towards the end of 1914.

Time and again officers, including General Currie, who is arguably the greatest soldier Canada has ever produced, praised the intelligence received, and acknowledged its role in winning battles. Indeed, Currie seemed at times a slave to information, unwilling to commit troops until the last vestige of information was

wrung from no man's land and the German positions opposite. For example, on April 4, 1917, Brigadier-General Billy Griesbach, commander of the 1st Brigade, fell foul with General Currie, commanding the 1st Division, at a time when Currie was trying to put the final touches on his plan for taking Vimy Ridge. It is worth quoting Currie in full.

My orders regarding the capture of a German prisoner are evidently not clearly understood. I want a prisoner, not for curiosity's sake, nor to see what he looks like. I want to get from him information that will be of some use to us in the preparation for the forthcoming operation, so naturally I want the prisoner before Zero Day.³

The plan [for a raid] submitted by the 2nd Battalion was puerile, in the first place because it involved the employment of nothing but scouts, and for a Battalion Commander to send in, as a raiding party, the scouts of his battalion, shows that at least he has no expectation of the open warfare season commencing.

In the second place, for a raid to succeed, there must be sufficient weight to it. Also the chances of success are increased when the men dash in under a barrage. At the present time, you cannot steal in into the German trenches. This is not a game of hide and seek we are playing.

I want you to tell your Battalion Commanders that, if they are not successful tonight, you will order raids at three hour intervals, until they are successful. Tell them I want results and I want them now.⁴

Currie was distressed by casualties and always sought to limit them. His obvious anger and frustration with the 1st Brigade reflected his belief that full knowledge beforehand led to fewer losses on the day of advance.

The sources also show that a massive accumulation of pre-battle intelligence was vital for reducing the battlefield confusion caused when communications collapsed during active operations. Communications, of course, are vital for effective command and control; not as ends in themselves, but for transmitting

³ During the war the date of an attack was usually referred to as 'Z' Day, or Zero Day, while the time of an attack was usually 'Z' Hour, or Zero Hour.

⁴ National Archives of Canada (NAC), Manuscript Group (M.G.) 30 E15 (Griesbach Papers) Vol. 3, File 18(B). Currie to Griesbach, April 4, 1917.

information to and from decision makers. During the First World War this flow was regularly disrupted due to the brittle nature of the communications systems then in use. During battles such breakdowns resulted in enormous confusion, something the Canadians experienced first hand at Second Ypres in April 1915, and at the St. Eloi Craters a year later. By 1917, however, the perfecting of set-piece attacks mitigated the negative effects of lost communications. These attacks were meticulously planned to the finest detail and, therefore, required an extensive accumulation of intelligence prior to launching. The resulting timetable tactics that set-piece attacks engendered limited battlefield confusion (at least for those in charge), as responses to all conceivable contingencies and difficulties were calculated in advance of the attack. In other words, set-piece attacks helped restore command and control functions to commanders who now made most of their critical judgments prior to the assault, and in the relative calm of normal trench warfare. Moreover, precision planning reduced luck and uncertainty, as artillery and infantry actions were prepared in advance. Now, should communications break down during an attack, as they surely would, the disruption in the flow of intelligence did not unduly impair the success of the larger plan, as all ranks knew their assigned tasks and objectives, and had practiced beforehand how to proceed. To be sure, intelligence collection continued during battle, but not so much for making crucial decisions, as for monitoring the progress of pre-planned actions. And although such fine-tuning could stifle local initiative amongst junior officers and men (at least at first), it did prove to be a winning formula for the Canadian Corps.

Meanwhile, the Canadian Corps' position in the larger British Army sometimes affected the utility of combat intelligence gathered by the front line troops. The fact that the Canadian command was subordinate to British authority meant that strategic and most operational planning decisions were made by the

British. The Canadians, regardless of what their intelligence organization told them, did not always have the freedom of action to alter British-made plans, particularly in the years before the Canadians earned their elite status. If the British ordered the Canadians to prepare an assault, that is what they did, even if intelligence reports suggested that such an assault was tantamount to suicide. The Canadians might object, and often did, but if a reprieve was not granted, they prepared their assault. This is not meant to be a criticism of army command structures, but it is important to remember that lower level formations were not always given much room to exercise independence of thought, be they Canadians or any other British formation.

During the first few months that the Canadians were in the line in 1915, this dilemma -- local intelligence gathered by the Canadians versus the larger British plan -- was not a problem. There were a number of reasons for this: first, the Canadians were itching for a fight, and were not about to let some water-filled ditch or uncut wire hold them back; second, the questioning of higher commands' decisions was frowned upon in the British and all other armies. Those officers who complained that their troops were not ready, or faced impossible situations, were bound to be sent home, or 'degummed' in the parlance of the day, as unfit to command, and without the necessary fighting spirit and will to win. Paradoxically, then, higher British command, while desirous of accurate intelligence, did not always cheerfully seek the opinions of subordinate commanders, nor opinions of those closer to the front lines.⁵ Finally, the Canadian intelligence service was in such a poor state early on that it did not gather much information of value anyway, and certainly little that might jeopardize British planning. Not that the poor state of

⁵ T.H.E. Travers, *The Killing Ground. The British Army, the Western Front and the Emergence of Modern Warfare, 1900 - 1918* (London: Allen and Unwin, 1990), 20-22. Paddy Griffith, *Battle Tactics of the Western Front. The British Army's Art of Attack, 1916 - 1918* (New Haven and London: Yale University Press, 1994), 7.

the intelligence system was of great concern to the Canadians, for as Colonel Duguid, the official historian, noted after the war: “[A]n elaborate system of intelligence would have been useless and detailed information of little value” to troops not trained or equipped to use it. “[S]o detailed information regarding the enemy’s disposition was a matter of comparatively little interest to the fighting troops.”⁶

Being a subordinate formation within the larger British Expeditionary Force meant that some of the Canadian Corps’ intelligence came from the British. The BEF’s General Headquarters (GHQ) had available to it numerous sources of intelligence: armies in the field, signals, allies, the army’s secret service, and the foreign office’s own secret service. GHQ was largely concerned with strategic and operational level intelligence, with its greatest interest being the German order of battle; that is to say, GHQ wanted to know the composition of the German Army, how the constituent parts were grouped to fight under the various commands, and the combat reputations of those parts.⁷ For example, GHQ wanted to know how many and which divisions made up particular German corps, what the artillery complement was in a division, what the battle history was of a given unit or formation, and an assessment of the different commanders’ abilities. Knowing the order of battle allowed for a greater understanding of the enemy’s capabilities and intentions. The number of divisions in a given sector was an indication of the number of German batteries located there, as each German division had a specific number of guns. In turn, the disposition of the artillery was usually a clear measure of the enemy’s aggressiveness. Much could be surmised by the number, calibre

⁶ NAC, Record Group (R.G.) 24, Vol. 1861, Folder 64. “The Canadian Intelligence Service,” by Colonel Duguid.

⁷ NAC, M.G. 30 E61 (Mitchell Papers) Vol. 16, Folder: Western Front, Orders and Instructions, 1914 - 1915. Lieutenant-General Robertson to 1st Army, March 15, 1915. Michael Occleshaw, *Armour Against Fate. British Military Intelligence in the First World War* (London: Columbus Books Limited, 1989), 37-38.

and range of German guns opposite, and by the exact direction they faced. Moreover, knowing the composition of the German Army, (i.e. the number of corps, divisions, brigades and regiments) permitted GHQ to follow individual formations and units across the front. By tracking troop movements and plotting their positions, GHQ could project the locations of German offensive and defensive operations due to the extra troops stationed in a given area, or through the thinning of certain lines. Identifying enemy units and formations was thus the major concern of GHQ. As a result, much of the intelligence gathering effort in the lower commands focused on identifying German troops opposite.

Furthermore, GHQ was interested in estimating the stamina of the German war machine and of the German home front. Evaluations on the state of German troop morale were regularly undertaken through a study of captured letters and diaries written by German front line troops. Prisoner interrogations were especially useful for shedding light on this particular aspect of GHQ intelligence. British intelligence officers also studied the quantity and quality of captured German trench food stocks in an effort to learn something about German troop morale, for morale, to some extent, rests on adequate sustenance. GHQ also calculated the average age of German prisoners of war (POWs) to determine the extent of available German manpower reserves. If, for example, the Germans were using 1917 class recruits in 1915, this would suggest that German manpower reserves were being used up faster than they could be replaced with men of military age. Such a turn of events would certainly be depressing to the German home front, if not the troops in the line, as younger and younger boys were taken from hearth and home and sent to the mud encrusted front line.

GHQ had an interest in tactical intelligence as well. It regularly issued translations of German documents outlining German tactical practices, and published its own tactical pamphlets. These were invaluable tools for lower level

commands when planning offensive and defensive operations. GHQ intelligence also supplied evaluations on German attack methods, defensive techniques and signals. In a February 23, 1915 memorandum, for instance, GHQ discussed the German propensity for swift counter attacks on any Allied gains, and counselled taking this fact into consideration when planning offensives.⁸ German documents describing lessons learned from recent fighting were also invaluable as guides for what to expect in the future. Again, friendly troops could prepare accordingly.

Progressing down the chain of command to army and corps headquarters, intelligence requirements shifted. By war's end, the British fielded five armies, all with intelligence interests similar to those of GHQ, but on a lesser scale. At the same time, armies wanted to learn more about the tactical situation along their fronts than was of interest to GHQ. Corps, on the other hand, were principally concerned with tactical intelligence, but had some interest in the larger strategic and operational interpretations made by army command and GHQ. Corps printed for distribution to lower formations and units a daily Intelligence Summary of the previous day's more salient discoveries and activities, including: the location of German gun emplacements; the depth and strength of wire entanglements and dugouts; the location of German billeting areas and lines of approach; estimates on how long it would take German reinforcements to arrive at a given trench system, and where their likely arrival area would be. Such findings were of the utmost importance to planners. As well, corps and armies were keenly interested in knowing what was happening *behind* the German front lines so as to better predict German activity, locate German guns and, in the event of a breakthrough, to know what lay in the green fields beyond.

Tactical dispositions were the main concern of divisions, brigades and

⁸ NAC, R.G. 9 III C3, Vol. 4021, Folder 50, File 11. GHQ to Armies, February 23, 1915.

battalions. Where *exactly* are the German machine guns placed? Where *exactly* are their listening stations, observation posts and command centres? Planners wanted answers to these and similar questions before any assault plans were finalized, for only then was there any chance of a successful plan being calculated and implemented. These commands, too, made every effort to learn the identity of the German units opposite, as front line commanders wanted to know for themselves the reputations of those they faced. To varying degrees, divisions, brigades and battalions were also interested in what lay behind the enemy's front line trenches. The battalions' main concern, however, was in learning about no man's land and the German front line trench system. Brigades had interests similar to battalions, but were also interested in knowing what lay further to the rear. Divisions were interested in the front lines, but looked even further back than brigades into German rear areas for information of concern to them. In effect, the closer a given command was to the front lines, the more detail that command sought on the German lines immediately across from them. The further back a command lay, the more interest it had in areas further behind the German front.

It was the unbroken trench system that defined the war and determined the role intelligence would play. General histories of the war regularly point out that the trench lines barely altered over the four years of slaughter. In a strategic sense this may be true. At the tactical, trench level, stagnation did not occur. Constant shelling and digging, for example, continually transformed the landscape. Canadian soldiers who fought at Second Ypres in April 1915, hardly recognized the battlefield when they returned to it in April 1916. By November 1917, during the Third Battle of Ypres, the terrain had become wholly unrecognizable. Where woods and farms once stood there remained but a few burnt stumps and the occasional brick or stone. Physical features were obliterated under the weight of millions of artillery rounds, and their locations were known only because they were

once marked on maps. Terrain features changed from one day to the next, and soldiers, even with maps in hand, often had no idea where they were. Defensive works, too, continually changed. Every day the Germans added new wire entanglements, strengthened and thickened those already in place, built dugouts, and shifted and camouflaged artillery emplacements, observation posts and unit headquarters. New and improved trenches were always under construction, saps dug, assault preparations made, and reliefs in the line undertaken. Each army experimented with and introduced new defensive methods. GHQ's call to identify the constantly shuffled German units was itself a tremendous task that devoured enormous time and effort. Commanders and men, to keep abreast of the incessant and rapid alterations to the ground and the enemy's position, required a well organized and efficient intelligence service.

The close proximity of the opposing forces offered a unique opportunity for a tactical intelligence service. Since opposing forces lived within rifle shot of each other, commanders had to be ever vigilant and prepared to meet an enemy foray at any time. The closeness of the enemy also diminished reaction time, which meant that any indication of an attack, however slight, had to be discovered to avoid surprise and possible catastrophe. Thus there was no respite from active campaigning as in past wars, when fighting was limited to fair weather months. The enemy was always present, and he had to be studied to learn his habits; it was vital for survival to recognize when he was in an aggressive or defensive mode. To this end, various headquarters units compiled detailed reports on observations made of German activity seen and sounds heard. Such a close analysis of the enemy produced a mountain of information for headquarters personnel to digest, most of which appears inconsequential when considered separately. Intelligence Summaries, and patrol and observation reports, for example, are replete with references to seemingly meaningless information: German parapet altered;

Germans talking in a particular trench or shell hole; a green flare over a certain sector; one enemy aircraft flying east to west at 10:30 a.m. over such-and-such a position. To trained and experienced intelligence personnel, this data helped build a repository of information on various sectors and the German activity therein. From such profiles, German intentions, resilience and resolve were surmised. The altered parapet might mean that gas cylinders were being readied for use, or that a German dugout or machine gun post was under construction. The men talking might reveal relaxed security on this part of the German line, and therefore an ideal spot for a Canadian raid. Intelligence officers would link the green flare to the activity that preceded or followed its firing to determine the meaning of some of the German signals. They would also track the aircraft's flight path to determine what the observer was observing, and to check how far behind friendly lines the plane traveled. Knowing what the observer may have seen could alter friendly planning. Flight path patterns might point to a possible German raid or attack on the sector in question. Determining how far behind friendly lines the plane traveled might show headquarters the depth of penetration the Germans expected to obtain, and the ultimate objective of the assault. Of course one aircraft, or one pile of lumber, or one flare was not conclusive evidence for formulating opinions of German intentions, but when amalgamated with the mass of other evidence collected, certain conclusions regarding enemy activity, habits and possible intentions, became clearer.

The closeness of the opposing lines did not mean that intelligence gatherers found collecting information on the enemy easy. It was not simply a matter of looking over a trench wall and writing down all that was seen. Time and again soldiers' diaries refer to the emptiness of the battlefield. Rarely did one see a live German. For one thing, anyone popping their head up over the parapet for more than a couple of seconds, and in the same spot more than once, was liable to lose it

to an enemy sniper. Moreover, one could not see everything that needed to be seen from friendly lines at ground level, even with the aid of a telescope or field glasses. An enormous effort was involved, and it became more complex as the war progressed. Techniques for unmasking enemy positions increased in complexity hand-in-hand with the enemy's efforts to conceal them.

The advent of aerial observation and the closeness of the opposing lines increased the use of camouflage and deception during the war. The British Army, for example, placed dummy soldiers in the trenches and manipulated them by ropes. It also used dummy sandbags, periscopes and sniper posts, and even built entire sections of dummy trenches. The artillery used camouflaged netting and hid their guns under trees and in towns. Artificial gun flashes helped deceive enemy flash-spotters. Fake gun emplacements, craters and tracks were also formed so as to trick aerial observers, and to deceive the photographic clerks examining the black and white images taken of the trenches. Prior to the Battle of Amiens in August 1918, the Canadians used bogus wireless traffic in an effort to deceive the Germans about their location. To aid in the art of deception the British created a camouflage organization in March 1916, and even concealed its intent by giving it the innocuous sounding name "Special Works Park R.E." In 1918, the Canadian Corps created its own camouflage officer to aid its deception efforts. The Germans, likewise, increased their concealment practices. Intelligence personnel were kept busy sifting through the false information to discover the truth about the opposing lines. Intelligence could also be used in more subtle ways to deceive the enemy. In the winter of 1915, for example, the Canadians used the tactical intelligence gathered on German positions against those same Germans. Suffering from a shortage of guns and ammunition, it was important for the Canadians to deceive the enemy as to the real state of their supply. By discovering the whereabouts of German machine guns, strong points, dugouts, and communication

trenches, and by plotting them on maps, gunners could more effectively target German positions. This was valuable information in itself; however, it had an added bonus in that ammunition could be more easily husbanded, as the artillery had specific targets and were not shooting at random. Additionally, the Canadians hoped that the Germans might be tricked into thinking that there was more Allied artillery in the sector than there actually was by the amount of destruction the guns inflicted, and by the speed of the retaliation.⁹

The strength of German defences themselves called for intimate and ongoing study. If assaults against a German position were to have any chance of success, the strengths and weaknesses of those defences had to be discovered beforehand. The Canadians soon realized that intelligence officers, by steadfastly monitoring the German position, could create profiles of given sectors outlining their suspected weak spots. They could also note patterns in German defensive methods that could be used to advantage. Knowing, among other things, where unit and formation boundaries ended, the usual time and frequency of troop relief, and the typical layout of a machine gun defence, aided Allied planning, helped win objectives, and reduced casualties in those commands that took the time to learn such details. Understanding friendly and enemy tactics was, therefore, another facet of successful intelligence work. Intelligence officers had to work hand-in-hand with the operations branch, and be current with improvements in the tactical deployment of both friendly and enemy troops. Knowledge of the overall plan was obligatory if needed information was to be gathered as part of an ongoing process.

⁹ G. W. L. Nicholson, *The Gunners of Canada; the History of the Royal Regiment of Canadian Artillery. Vol. 1., 1534 - 1919* (Toronto: McClelland & Stewart, 1967), 246; Various Authorities, *Canada in the Great World War; an Authentic Account of the Military History of Canada from the Earliest Days to the Close of the War of the Nations*, Vol. 3. (Toronto: United Publishers of Canada Limited, 1919), 221; J.A. MacDonald, ed. *Gun-Fire: An Historical Narrative of the 4th Brigade C.F.A. in the Great War (1914 - 18)* (Compiled by the 4th Brigade C.F.A. Association, 1929), 32; James Edmonds, *Military Operations, France and Belgium. 1916*, Vol. 5 (London: Macmillan and Co., Limited, 1933), 81.

Intelligence personnel had to understand enemy tactics in order to know what to look for, when to look for it, and where to concentrate their efforts.

Intelligence organizations, moreover, were only as good as those who staffed them. The Canadians were fortunate to have had commanders such as Byng and Currie who valued intelligence highly. The Canadians were also blessed with exceedingly proficient intelligence officers such as Lieutenants Colonel C.H. Mitchell, J.L.R. Parsons, and W.R. Bertram, to name just three of the many men who served as intelligence officers during the war. This is not to say there were no problems. Throughout the war, even while enormous progress was made in how intelligence operated in the Canadian Corps, there remained a few line officers who seemed unable to get it in their heads that intelligence mattered, and that the leakage of information to the enemy was a real problem. In July 1917, the 1st Canadian Division was still able to bemoan the poor intelligence reports it sometimes received from brigades, which were usually the result of inferior reports generated further up the line. The complaint was that they lacked specificity and accurate detail.¹⁰ Earlier that year, in February, a notice by Lieutenant Colonel A.H. Bell, then in temporary command of the 6th Brigade, outlined the brigade's intelligence policy and felt the need to remind all ranks of the importance of intelligence to winning the war, and this after two years of bloodshed that had regularly identified the value of accurate and timely information. Point one on Bell's memorandum reads:

[The] Importance of Intelligence Work is not fully realized. It is a matter of supreme importance. This branch of Military Work is most interesting and particularly lends itself to the art of ingenuity, and offers a vast field of action for bold and skilful leaders of patrols, (includes all ranks): Some Canadians are particularly suited to this work and Canadian Units, as a rule, render good service in this respect, but better work is needed and is possible.¹¹

¹⁰ NAC, R.G. 9 III C3, Vol. 4025, Folder 7, File 5. 1st Canadian Division to 1st Brigade, July 25, 1917.

¹¹ NAC, R.G. 9 III C3, Vol. 4130, Folder 8, File 1. Lieutenant Colonel A.H. Bell to Units and to the staff captain(I), February 18, 1917.

Currie would have agreed with Bell's assessment that intelligence work was sometimes undervalued and underutilized. In his January 1917 report on the French attacks at Verdun, Currie stated that "I am quite certain that [Canadian] Company Commanders are not now paying that attention to the information that is available in the intelligence department, that is desirable."¹²

As such, intelligence and other officers regularly lectured both green and experienced troops on the need for intelligence, and the perils of information leakage -- a problem that persisted to the end. Two examples should suffice in showing how simple it was for officers and men to surrender information to the enemy. Throughout the war, some officers carelessly entered carefully concealed observation posts (OPs) during daylight hours in an effort to gain panoramic views of the battlefield. This often surrendered their location to German observers. The intelligence officer in the 6th Brigade complained of this delinquency in March 1916.

It is a matter of constant complaint that men from all units visit the Brigade observation posts in the rear of our line, exposing themselves to the enemy's view and thereby running the risk of disclosing the location of these O.P's. Good observation posts are difficult to find in the rear of our line and when one of the existing posts is discovered and shelled by the enemy, it is practically impossible to replace it with another as good...Brigade observers have orders to arrest or report any unauthorized persons who persist in visiting these observation posts during daylight.¹³

The 1st Division's "Organization of Intelligence Sections," issued on March 3, 1918 continued to complain about the loss of OPs due to officer carelessness,

¹² NAC, R.G. 9 III C3, Vol. 4163, Folder 12, File 10. "Notes on French Attacks, North-East of Verdun in October and December, 1916," by Major-General Currie, January 23, 1917.

¹³ NAC, R.G. 9 III C3, Vol. 4138, Folder 6, File 12. Staff captain(I), 6th Brigade to battalion commanders, March 13, 1916.

“particularly...Officers who use the O.P.’s out of curiosity.”¹⁴ Officers were also guilty of saying too much over telephones easily tapped into by the Germans. GHQ thought that leakage was so voluminous that it ordered telephones removed entirely from trenches forward of battalion headquarters (except during active operations).¹⁵ Friendly listening post personnel monitored telephones used behind this point and reported all infractions to a higher authority that did not look favourably upon telephone misuse. Some officers continued to abuse the telephone system, however, and in the process surrendered valuable information to the Germans.¹⁶ One message, intercepted on May 30, 1917, ran:

Hello PD get the SM for me ____ Can you give me some idea what it was? Can you give me any idea of how much wire you put out? About a company frontage, 250 yards. That all. Right. Very Good.¹⁷

A rather innocent conversation, with the exception that it told any Germans listening in how much new wire they faced; and told them without their having to leave their trenches. It also told the Germans that a company frontage was about 250 yards wide. Knowing the width of a company frontage, and the size of a Canadian

¹⁴ NAC, R.G. 9 III C3, Vol. 4025, Folder 7, File 5. “Organization of Intelligence Sections,” March 3, 1918.

¹⁵ NAC, R.G. 9 III C3, Vol. 4143, Folder 8, File 3. 6th Brigade to Units, July 29, 1917; R.G. 9 III C4, Vol. 4246, Folder 9, File 4. Notice by General Officer Commanding Royal Artillery, Canadian Corps, March 30, 1917; R.G. 9 III C3, Vol. 4163, Folder 10, File 3. “Notes on Conference Held at Canadian Corps H.Q.,” March 30, 1917. Various instructions on the proper use of telephones in the forward area were issued well into 1918, and probably to the war’s end. See R.G. 9 III C4, Vol. 4334, Folder 7, File 7. Canadian Corps “Instructions Governing the Use of Telephones in the Forward Area,” February 1, 1918, for example.

¹⁶ NAC, R.G. 9 III C3, Vol. 4041, Folder 17, File 11. 1st Canadian Brigade to Units, May 23, 1916. See also John Ferris’ article titled “The British Army and Signals Intelligence in the Field During the First World War,” *Intelligence and National Security* 3.3 (October 1988): 23 - 48.

¹⁷ NAC, R.G. 9 III C1, Vol. 3836, Folder 28, File 10: Listening Sets: I.T. 2nd Canadian Division, May 1917. The underlining was done in red pencil, perhaps by the officer to whom the intercepted message was given. It is not known what reprimands, if any, were meted out for this breach of security.

company (a relatively easy number to acquire), a quick calculation told the Germans how strongly the trenches in this sector were held.

At other times, officers and men held onto intelligence until well past its usefulness, another indicator that some individuals did not appreciate the full value of combat intelligence. In January 1916, one officers' meeting concluded that the need for speedy transmission of information "is not yet sufficiently realized." Too often valuable information that should have been sent to the rear immediately was not reported until up to twenty-four hours after its discovery. The example given at the meeting concerned targets of opportunity that the heavy artillery might have engaged had they been promptly informed. The attendees concluded that many officers believed that it was sufficient for the information to be submitted in time for publication in the daily Intelligence Summary (which might be issued well past the point where the information was of use to the gunners). This was difficult behaviour to eradicate.¹⁸ Nine months later, officers of the 6th Brigade noticed that captured documents were being unduly held on to by front line units, sometimes for four or five days. Oftentimes their usefulness was lost as a result.¹⁹ A similar problem concerned soldiers holding on to captured documents as souvenirs rather than handing them in for evaluation.

We should not be overly distracted, however, by the difficulties the Canadians faced over the years when developing their intelligence system. The fact remains that most Canadian officers, from very early on, recognized the value of intelligence to operations. Almost immediately upon assuming control over their first section of trench in March 1915, the Canadians began to improve their intelligence service. Certainly they were unaware of the full array of problems they

¹⁸ NAC, R.G. 9 III C3, Vol. 4137, Folder 2, File 10. Brigade major, 6th Brigade, to 28th Battalion, January 24, 1916.

¹⁹ NAC, R.G. 9 III C3, Vol. 4138, Folder 5, File 11. 6th Brigade to Units, September 20, 1916.

would face in a modern trench war, but they learned quickly that one way to overcome problems, or at least to decrease their severity, was to be informed. After the near disaster at Second Ypres in April 1915, and the defeat at Festubert in May, the Canadians embarked on a path to victory that demanded full disclosure and the collection of all possible information on the German positions and the intervening no man's land, no matter how trivial it might first appear. As we will see in the following chapters, the rigid plans created from this information were, in fact, a form of liberation for commanders trying to retain control over the action, as they helped reduce battlefield confusion, chance and luck. Intelligence work became so important that by the end of 1915 the Canadian Corps recognized it as a specialized task. Indeed, as early as August 1915, the 2nd Canadian Division, then in training in England, and in response to lessons learned by the 1st Canadian Division, began organizing battalion-level intelligence sections where none had previously existed.²⁰ The shock of trench warfare shook the Canadians into action, and illuminated the need for accurate and timely information. Over the next three years of fighting the Canadian intelligence system evolved to meet new and pressing needs, and changing tactical environments. In the process it contributed enormously to the Canadian Corps' battlefield success.

²⁰ NAC, R.G. 9 III C3, Vol. 4143, Folder 8, File 8. "Organization and Training of Battalion Scouts. 2nd Canadian Division," n.d., likely July 1915. See also Manuscript Group (M.G.) 30 E241 (Macintyre Papers) Vol. 1. Diary entries for June - August 1915. During this period Macintyre was appointed the 28th Battalion's first scout officer, and was responsible for organizing and training the intelligence section.

CHAPTER TWO

EXPECTATIONS

When war came to Europe in 1914, Britain and the various European Great Powers expected a quick campaign, and a war of movement that would see the contest decided after two or three decisive engagements. The Canadians, being a part of the British Empire, and emulating British military practices, training and traditions, accepted the British view. Field intelligence had an important role to play in such a war, helping commanders locate opposing armies while they manoeuvred their own into advantageous positions from which to assail or meet an enemy thrust. Strategic intelligence as to the general whereabouts of the enemy was traditionally collected by cavalry on long and wide ranging reconnaissance sweeps. These cavalry patrols gathered information on the direction that the enemy was moving and by what routes, estimated his strength, and accumulated any other detail that might prove of value to the friendly force commander. They also acted as a protective screen, blocking enemy efforts to discover truths about friendly positions and movements. Upon receiving the cavalry's information the force commander made evaluations and decisions. Ideally, information arrived at headquarters in a fairly continuous and regular stream, thereby allowing commanders to command and control the situation as it unfolded, with each new bit of news helping to modify or reinforce decisions already made.

By 1912, the British Army's *Field Service Regulations (FSR)* recognized that an air service would likely assist the cavalry in gathering long range intelligence. Aircraft, it said, are "one of the most valuable means of obtaining

information” on behalf of commanders. However, the air service, then in its infancy, was not a replacement for traditional cavalry. The *FSR* stated:

An efficient air service...working in co-operation with the independent cavalry will be able to contribute much towards the success of a strategical reconnaissance even in face of a superior force of hostile cavalry; but in fog, wind, or darkness the air service can accomplish little or nothing, and it must be regarded as supplementing, and not as a substitute for, strategical reconnaissance by the independent cavalry.¹

This was fair commentary on a new and relatively untested technology that obviously suffered a number of serious drawbacks. Locating enemy ground troops from the air, especially if concealed, was very difficult. The *FSR* suggested that aircraft approach the enemy line from the rear, as the rear was less likely to be camouflaged, and less dangerous to airmen whose rearward approach might fool the enemy into believing that they were friendly aircraft. Communications from the air also limited the usefulness of aerial observation, as the problem of air to ground communications had yet to be solved. This was not so much a problem for observers stationed on the sturdier and more roomy platforms of lighter than air ships (dirigibles and kite balloons), where wireless, pigeons, light signals, or telephones could be employed to varying degrees of success, but for heavier than air ships (airplanes), whose communications to the ground had yet to be fully developed.²

Ground troops collected the more local, tactical information. While on the move the main body threw out advanced and flanking guards that normally consisted of elements from the three standard service arms: the infantry, the

¹ National Archives of Canada (NAC), Record Group (R.G.) 24, Vol. 22,008. *Field Service Regulations, Part I, Operations, 1909* (reprinted with amendments, 1912), Section 91, (*FSR*).

² NAC, R.G. 24, Vol. 22,008. *FSR*, Section 95.

artillery and the cavalry. Officers of the general staff often accompanied these advanced and flanking formations, and kept the force commander informed of developments along the front and flanks. The guards collected information as they advanced, and acted as security screens, giving warning to the main body of troops if the enemy struck. When at rest for extended periods, or at night, the advanced and flanking guards established outpost lines to guard the main force and protect it from surprise enemy assaults. The various outposts, in turn, arranged continuous picketing and patrolling of the front. The outpost and picket line acted as an additional warning system, and tried to obtain information on any nearby enemy forces. This was accomplished by questioning the local population, intercepting enemy messengers, capturing documents and prisoners, and by infiltrating the enemy's defensive screen to directly view his position.³

If battle seemed imminent, the friendly force commander sought special details on the enemy's tactical arrangement. He wanted information on the extent of the enemy's position, the location of any weak points, information on the terrain, especially those points which, if captured, would render the enemy's position untenable, and information on the best point from which to launch an attack. Details on the placement of friendly troops were also sought, particularly when waging a defensive battle. This included information on the best line of defence, the flanks, the most effective artillery positions, points from which the enemy could overturn a friendly position, probable locations of enemy artillery, and positions to be occupied in case of retreat.⁴ Naturally, the quality of information collected depended very much on the vigour and attentiveness of those doing the gathering.

Figure 2.1, "Prewar Intelligence Gathering During an Advance and in Close

³ NAC, R.G. 24, Vol. 22,008. *FSR*, Sections 75 - 89.

⁴ NAC, R.G. 24, Vol. 22,008. *FSR*, Section 96, 97, 98,

Proximity to an Enemy Force,”⁵ illustrates something of the intelligence gathering process required prior to actual fighting.

During battle the collection of intelligence continued. Traditionally, unit and formation commanders, or their representatives, watched the action from some advantageous piece of ground, probably through field glasses or telescopes. The *FSR* recommended that corps and higher commanders not personally reconnoitre the field, but trust to reports by the cavalry and their staff officers. The problem with these commanders making their own reconnaissance was that they could not possibly observe the entire front, and “A personal reconnaissance which can only be partial may result in too much importance being attached to what has been seen at the expense of what has not been seen.” Closer to the action the infantry and cavalry scouts continued to play a role. They attempted to patrol around the flanks and rear of the enemy’s line in order to learn more about specific tactical dispositions and terrain features. Field manuals reminded intelligence gatherers that “The value of information depends to a great extent on the length of time that has elapsed since the events occurred,” and asked them to send back intelligence “with the least possible delay.”⁶

Obviously the British valued good tactical, combat intelligence. The *FSR*, 1912 edition, and the 1914 *Field Service Pocket Book (FSPB)*, the abbreviated version of the *Field Service Regulations*, were quite clear on the need for, and the value of, tactical information. The *FSR* reads:

Timely information regarding the enemy’s dispositions and the topographical features of the theatre of operations is an essential factor of success in war. Systematic arrangements must always be made to ensure that every possible source of information is fully utilized, that all information received is immediately transmitted to the proper quarter, and that it is carefully sifted before any conclusions are formed. These

⁵ Based on descriptions in the *FSR*.

⁶ NAC, R.G. 24, Vol. 22,008. *FSR*, Sections 93, 96, 97, 98.

Figure 2. 1: Prewar Intelligence Gathering During an Advance and in Close Proximity to an Enemy Force

A. Intelligence Gathering by a Force During an Advance

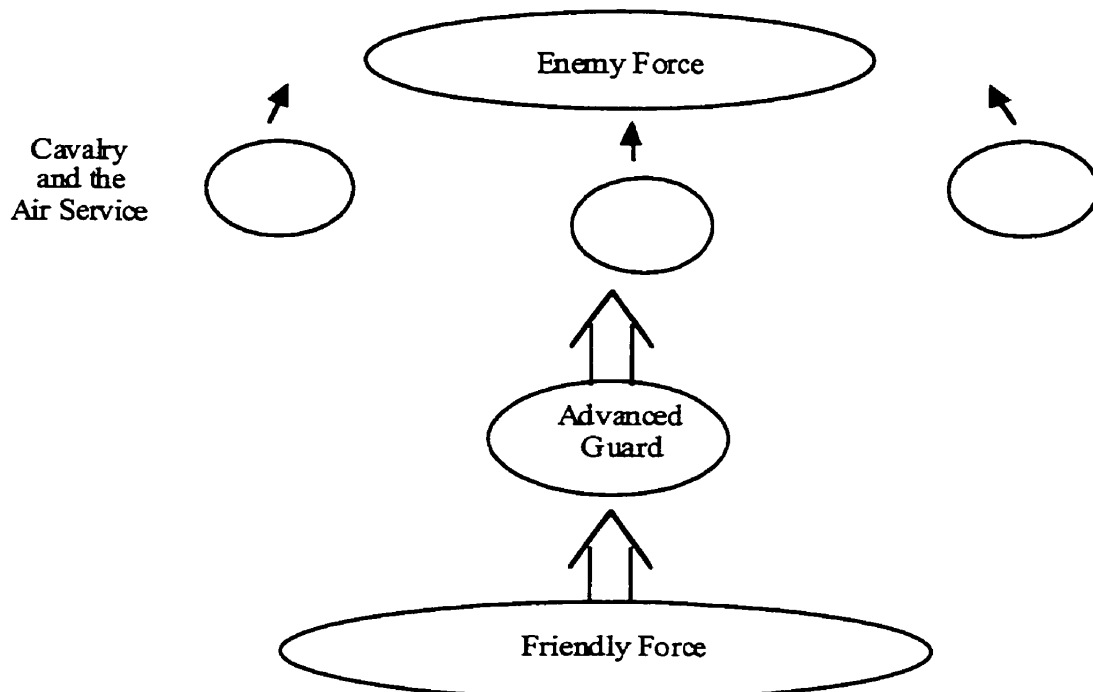

B. Intelligence Gathering by a Force at Rest

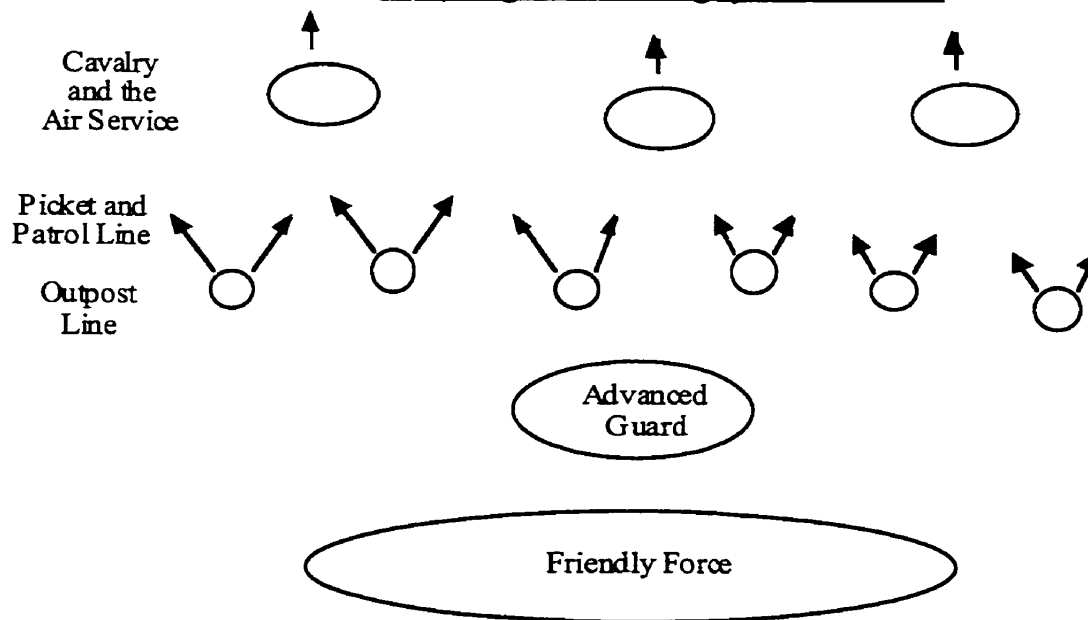

are the duties of the general staff.⁷

Further, Brigadier-General David Henderson, the highly respected writer on tactical intelligence introduced in Chapter One, stated in his *Art of Reconnaissance* that:

The acquisition of information about the enemy has always been considered one of the most important elements of success in war. A commander without information is like a man blindfolded; he knows neither where to strike nor from what quarter to expect attack; he is unable to make a plan for himself, or to guard against the plan of the enemy.⁸

Indeed, the *FSR* pointed out that “time spent in reconnaissance is seldom wasted,” and advised that “unless the situation demands instant action, a commander of a division or of a smaller unit should never commit his troops to an engagement until he has made a personal survey of the ground before him.”⁹

Before the war the intelligence gathering experts amongst the fighting troops (infantry scouts and cavalry) underwent special training that emphasized map work, sketching, stealth, reading the enemy, report writing, basic signalling, and other reconnaissance skills. Many of these abilities, while transferable to siege warfare, were taught in anticipation of a war of movement, where targets were fleeting, and did not require the accumulation and storage of details that became characteristic of trench fighting. The idea was to collect accurate information quickly, and transmit it to the appropriate commanders for their immediate use. Every enemy machine-gun and gun emplacement need not be pinpointed on field maps and recorded for future reference. In quick changing situations tactical dispositions evolved quickly, with commanders on the scene dealing with events as they unfolded. The shelf-life

⁷ NAC, R.G. 24, Vol. 22,008. *FSR*, Section 90.

⁸ David Henderson, *The Art of Reconnaissance*, 3rd. ed. (London: John Murray, 1914), 1.

⁹ NAC, R.G. 24, Vol. 22,008. *FSR*, Section 93.

for most tactical intelligence was brief, so commanders need not store or bother higher authorities with such ephemeral detail.¹⁰

The prewar artillery did not undertake any special intelligence training. Training emphasized the need to get batteries into action quickly. Gunners in all armies, including the British, trained to fire their guns over open sights at observed targets, and so indirect fire -- with all the tactical intelligence elements such firing entailed -- was not seriously considered.¹¹ Training in firing from the map, and at night was largely neglected, as was counter battery intelligence work. The neglect of counter battery intelligence is somewhat surprising considering the known difficulties of locating guns camouflaged against aerial observers, and placed well back from the front line and out of sight to friendly gunners similarly placed. Brigadier-General N.D. Findlay commented on this at a 1912 meeting of the Royal United Services Institute:

at the commencement of an offensive action...the enemy will almost certainly have his guns completely hidden behind cover. He will open fire upon our infantry and probably we shall not be able to locate his guns. At present we have no means of locating them, and we are told in the *Training Manual* not to expend vast quantities of ammunition upon an objective which we do not see. What is very much wanted, therefore, is more practice in locating targets in concealed positions, and bringing fire to bear on them by means of observation from aircraft.¹²

¹⁰ G.W.L. Nicholson, *The Gunners of Canada. A History of the Royal Regiment of Canadian Artillery, Vol. 1, 1534-1919* (Toronto: McClelland & Stewart, 1967), 210; A.F. Brooke, "The Evolution of Artillery in the Great War, Part II," *Journal of the Royal Artillery* 51.6 (January 1925), 370; Bill Rawling, *Surviving Trench Warfare. Technology and the Canadian Corps, 1914 - 1918* (Toronto: University of Toronto Press, 1992), 13 - 15.

¹¹ With indirect fire the gunners fire their batteries at targets they cannot see, using map references as a guide.

¹² Commentary made by Brigadier-General N.D. Findlay on Major C.E.D. Budworth's "Training and Action Necessary To Further Co-operation Between Artillery and Infantry," *Journal of the Royal United Services Institute* 57 (1912), 82.

At most, artillery forward observation officers (FOOs), placed well ahead of the gun line, observed the fall of shot, located enemy batteries close enough to see, searched for targets of opportunity, and telephoned or signalled this information to the gunners further to the rear. Despite the efforts of FOOs, however, when the various armies faced off in the First World War they did not normally engage each other's guns in a systematic manner -- at least during the first half of the war -- for the simple reason that batteries on both sides went undetected. Instead, the infantry received the brunt of the artillery pounding.

The Canadian Militia reflected British military training, organization and practices, as the Canadians fully expected to fight alongside Britain in any future war as part of an imperial war effort. As such, the prewar Canadian Militia trained in the traditional manner using British manuals as guides. The average soldier received some scout training, but was not expected to be expert. Infantry and mounted scouts, being the reconnaissance specialists, practiced reconnoitring work and studied, among other things, map reading, message writing, field sketching, verbal and written reporting, moving across country, compass work, tracking and reconnaissance, visual training and concealment.¹³ According to one lecturer, scouts had to understand nature, possess sporting instincts, and see without being seen. When off duty they could hone their skills by tracking animals when walking in the country, and by memorizing items seen in storefront windows when strolling around town.¹⁴ Some officers believed that scouts were born, not made, and that training developed their natural skills. Non-natural scouts could still benefit from

¹³ NAC, R.G. 24, Vol. 6526, Folder H.Q. 493-1-1. Major C.H. Mitchell to General Staff Officer, 2nd Division, November 10, 1911. "Memo Re Training of Brigade Scouts."

¹⁴ NAC, Manuscript Group (M.G.) 29 E92 (Lawrence Hurt Sitwell Papers) Folder: 'Captain Sitwell Lecture, March 1909.' Lecture title: "A Scout is born - not made, but much that is lacking in birth may be made up for by careful training." Also, Dan Jenkins, "The Corps Of Guides, 1903 - 1914," *Canadian Military History* 5.2 (Autumn 1996), 88-98.

training, however, as Captain Lawrence Sitwell of the Canadians Corps of Guides lectured in 1909. This was not an opinion subscribed to by David Henderson; he thought the notion that scouts were born and not made was nonsense, and “confined to those who have had no experience in reconnaissance.” Henderson believed that the qualities that made for a good scout were the same ones that made a good soldier. According to Henderson, the best scouts were “guided by a combination of courage and caution: both these qualities are essential, and the lack of either is fatal to efficiency.” He added: “A timid scout is not of much use, but a dead scout is of no use at all, and a scout who is captured may be a danger.”¹⁵ He believed several factors contributed to effective scouting:

Concealment in advancing; the occupation of a good post of observation; recognition of a possible danger; prolonged scrutiny of the dangerous point, and detection of the enemy; consideration of possible courses [of action], and the balancing of the value of the information against the risk of obtaining it; knowledge of the enemy’s methods; and lastly, a definite plan.¹⁶

All of these qualities remained vital in the trenches of the First World War. Captain G.B. McKean, a scout officer in the 14th Canadian Battalion during the war, felt that a “scout’s *honour* is the most important thing of all.” “If a scout isn’t to be trusted,” he said, “then he’s no good to me, and he will be no good to his commanding officer.”¹⁷

Knowing ones’ job, however, did not mean one was necessarily proficient. In June 1914, Canadian Militia field exercises at Nanaimo, British Columbia uncovered a number of scouting weaknesses. Post-exercise evaluations, while careful to note the enthusiasm of the scouts, pointed out that scouts had difficulty

¹⁵ Henderson, *The Art of Reconnaissance*, 75-76.

¹⁶ *Ibid.*, 80-81.

¹⁷ G.B. McKean, *Scouting Thrills* (New York: The Macmillan Company, 1919), 4.

penetrating the terrain, collecting intelligence, and transmitting it to headquarters -- in essence, they were weak in all scouting functions. Moreover, they failed to post an outpost line in advance of the main body, and they tried to cover too much ground, so much so that in the end they missed a great deal, including entire river crossings. The commander of the 'Blue Force' felt that

Scouting on the whole was not exceedingly good, the country was difficult and there seemed, with the exception of a few isolated cases, a fear of penetrating too far from support, the thickness of the bush may in some cases answer for this. A fear also of being captured may also have some bearing on this. A want of initiative was, I think chiefly the fault. Officers in training their men in the future might well take this subject of scouting up more closely.¹⁸

Two days after this exercise commenced, the Archduke of the Austro-Hungarian Empire, along with his wife, were assassinated. The Great War was little more than thirty days away, and the Canadian Militia's front line intelligence gatherers needed a great deal more work.

Intelligence training in the prewar Canadian Militia suffered in other respects besides poor scout work. For starters, it had no experience with aerial reconnaissance and photography. This is not surprising considering Canada did not have its own flying corps. Despite this shortcoming aerial reconnaissance was not unknown. In a 1911 report entitled "Aerial Navigation in Warfare," Captain C.H. Mitchell of the Canadian Corps of Guides, and who during the Great War rose to prominence in both the Canadian Corps and the British Army as an intelligence officer, described his vision of the role of aircraft in warfare. Significantly, he saw it as a valuable tool for reconnaissance and antisubmarine

¹⁸ NAC, M.G. 30 E84 (Leckie Papers) Folder: Military Orders, 1914. Major de Salis, Blue Force commander to Lieutenant-Colonel J.A. Hall, Chief Umpire, July 4, 1914.

work, and for spotting and directing artillery fire, among other things. He was also somewhat futuristic when he predicted the development of helicopters. He wrote:

There is no doubt that very shortly a vertical lifting 'heavier than air' machine will be brought out capable of standing stationary or hovering over any point; this will probably combine the horizontal speed properties of the aeroplane.¹⁹

Nevertheless, and despite Mitchell's efforts and insights, the Canadian Militia entered the war without experience with aircraft.

Unlike the British Army, the prewar Canadian Militia did have an organized field intelligence force -- the Corps of Guides.²⁰ The Corps of Guides was a mounted force in the non-permanent Active Militia, formed in 1903 in response to lessons learned from fighting the Boers in South Africa. It was designed to serve both a peace and wartime role. When on campaign it was meant to act as a combat intelligence force for Canadian armies in the field, supplying commanders with tactical and operational intelligence. During peacetime it prepared for this eventuality and, perhaps most importantly, helped accumulate intelligence on Canada's potential military resources and enemies, in particular the United States. Officers without military experience were appointed to the corps on a provisional basis, and given one year to pass the corps' examinations, and obtain a subaltern certificate in one of the three combat arms. Likewise, officers with previous militia experience also had to pass these examinations, while officers with at least two years service in the regular British Army, or in a permanent force of one of the Empire's Dominions, had only to pass the equitation examination, unless their previous experience was in a mounted unit. As with all of Canada's peacetime military establishments, the Corps of Guides was starved of funds, staff and

¹⁹ NAC, R.G. 9 II C2, Vol. 8: Militia Department, Military Intelligence: Corps of Guides. Report 11: "Aerial Navigation in Warfare," by Captain C.H. Mitchell.

²⁰ The British India Army, however, had a field intelligence force.

training, but was still able to provide an important service during the prewar years by providing its members with a background in field intelligence work that proved indispensable in the coming war.²¹

The annual *Militia Reports*, prepared by the Militia Department for the Government of Canada, regularly looked favourably on the Corps of Guides and its work. The *Militia Report* for the year ending December 31, 1905, stated that “the duties of this corps are varied, and while only organized two years ago, excellent and useful work is being done by them in matters of surveying and furnishing valuable information.”²² The 1909 *Militia Report* was similarly definite in its praise. “Thanks are due to the officers of the Corps of Guides for the willing assistance they rendered during the year in collecting and communicating intelligence. The reports which they send in are always useful, sometimes very valuable.”²³ General Sir John French, the Inspector General in Britain, in his 1910 report on the state of the Canadian Militia was equally impressed. He wrote: “I regard the establishment of the Corps of Guides as being a most valuable and useful adjunct to the staff. I think it is a principle which is capable of extension.”²⁴

Training, however, was minimal in the Corps of Guides. When it did occur, British cavalry manuals were followed, meaning the corps prepared for a traditional war of movement. Training languished from the fact that the Corps of Guides met for just sixteen days per year to train as a unit (although individual training continued throughout the year). Moreover, until 1912, there were no guides in the Corps of Guides, only officers. Guides were listed as present at

²¹ NAC, R.G. 9 II B3, Vol. 66: *General Orders, 1911*, General Order No. 41. Also Jenkins, “The Corps of Guides,” 88 - 98.

²² *Militia Report* for the year 1905.

²³ *Militia Report* for the year ending March 31, 1909.

²⁴ NAC, R.G. 9 II C2, Vol. 8: Militia Department, *Military Intelligence: Corps of Guides. Report 24*. “Report by General Sir John French, GCB, GCVO, KCMG Inspector General of the Imperial Forces Upon His Inspection of the Canadian Military Forces,” 1910.

annual camps before this date, but in truth they were officers' grooms and batmen.²⁵ Training for field command no doubt suffered which, ironically, may not have been such a bad thing in light of the type of fighting the Canadians experienced during the First World War. Guide officers going off to fight in the Great War would have understood basic intelligence principles, but would not have been encumbered by outmoded techniques.²⁶ Of course, officers of the day did not likely see it that way, and Major E.T.P. Shewen, of the Corps of Guides detachment based in New Brunswick, was one. In 1907 he wrote:

I am very much in earnest about this matter. We have long been held up to ridicule, as being a regiment of officers without men. I can assure you, speaking as a civil engineer, it is impossible to do without men if you want to get any work accomplished.

He further stated that:

It is absurd to suppose that five officers, in a military district comprehending 28,000 square miles, could, in time of war, conduct an effective, local, intelligence service, that is to say, one that could furnish information of an enemy's approach, open or disguised, by sea or land. It would be equally unreasonable to assume that in event of a crisis, men, picked up at a moment's notice, would prove efficient scouts...or would be able to satisfactorily perform the important duty of keeping a look-out, exercising judgment and giving notice, by wire, to the nearest officer commanding, if occasion required.²⁷

He made a valid criticism, but it took five more years to correct.

By 1912, even the normally supportive *Militia Reports* hinted that all was not right with the corps. That year, the need for high quality officers was discussed, and the observation made that "in no other branch does 'dead wood' so

²⁵ NAC, R.G. 24, Vol. 4256, File: MD1 512: Functions of the Corps of Guides. Folder 5-1-2. See also the 1905 *Militia Report*.

²⁶ Dr. John Ferris to the author, July 29, 1998.

²⁷ NAC, R.G. 24, Vol. 6526, Folder: HQ 493-1-1: Training of Brigade and Regimental Scouts. Major E.T.P. Shewen to Major, January 23, 1907.

materially mar efficiency as in the Corps of Guides.” This was tempered by the statement that, “with very few exceptions,” officers were cognizant of the “importance and highly technical cast of their duties.” There were also insinuations that ill-feeling towards the corps was brewing throughout the army. “Hitherto,” the *Militia Report* reads, “in the eyes of many, little or no thought has been given to [the corps’] value and responsibilities, consequently [the corps] has been looked upon as a comfortable refuge for such as desired rank and uniform without the attending sacrifices.”²⁸ Furthermore, the 1913 *Militia Report* expressed regret that Royal Military College graduates who joined the corps tended to “evade their obligation as to training, and for this reason a doubt is created as to whether such a desirable source can be counted upon to fill vacancies.”²⁹ Early that same year Lieutenant Colonel George Paley, the officer administering the Guides, noticed that there was a

tendency on the part of some members of the Corps to think that officers intended for these appointments, will derive little benefit from the nature of the training at camp, and that they should therefore be excused. This is very erroneous...[Such a position] would be to acknowledge that any civilian of good standing in his business or private profession would be equally suited, and consequently one of the strongest arguments for the maintenance of the Corps of Guides would be removed.³⁰

In other words, if officers did not need to train, then perhaps critics of the organization were correct in their assertion that a field intelligence organization was an unnecessary luxury during peacetime.

Even the corps’ battlefield role and organization left many confused. Paley

²⁸ *Militia Report* for the year ending March 31, 1912.

²⁹ *Militia Report* for the year ending March 31, 1913.

³⁰ NAC, R.G. 24, Vol. 4256, File: MD1 512: Functions of the Corps of Guides. Folder 5-1-2. Lieutenant Colonel George Paley to Officer Commanding First Division, January 30, 1913.

thought this was understandable since the corps did not fit into the “stereotyped organizations with which [commanders] are familiar.” Since the corps contained no guides until 1912, “no clear ideas ever appear to have been expressed as to the exact organization, training and employment in war of the rank and file.” Paley felt the need to explain the unit’s wartime role in a letter to the commanding officer of the 1st Divisional Area. He wrote that “the Guides could be of service in the opening of a campaign in patrolling, scouting, and despatch riding, whilst, from their local knowledge, they would come in particularly useful for any independent reconnaissance.” If nothing else, they could act “as expert despatch riders and for intercommunication purposes...a service the want of which is apparent in every campaign.” Paley also thought that the Guides would probably “prove of value in making rough sketches and plans required by the Staff, and in providing Intelligence Police,” and in gathering “information under cover of the protection afforded by the troopers, especially so at first before the cavalry had developed much expertness in the art of scouting.” Guides, he believed, could also watch friendly lines of approach and give early warning of enemy movements.³¹

Figure 2.2 illustrates how the prewar Canadian Militia organized its information flow during its 1911 tactical exercise held on Thanksgiving Day. During the exercise two opposing divisions met in an encounter battle. An intelligence officer was on the staff of both forces, and collected, studied, collated, and disseminated information as it arrived at headquarters. They also arranged for any special reconnaissance patrols called for by the force commander. They helped validate reports, selected worthy objectives for investigation, and made arrangements to obtain any needed information. As such, they were supposed to be kept informed of the force commander’s plans and intentions.³² During the exercise

³¹ Ibid.

³² Henderson, *The Art of Reconnaissance*, 70-71, 161-162.

Figure 2.2: Methods of Obtaining and Transmitting Information During the 1911 Tactical Exercise

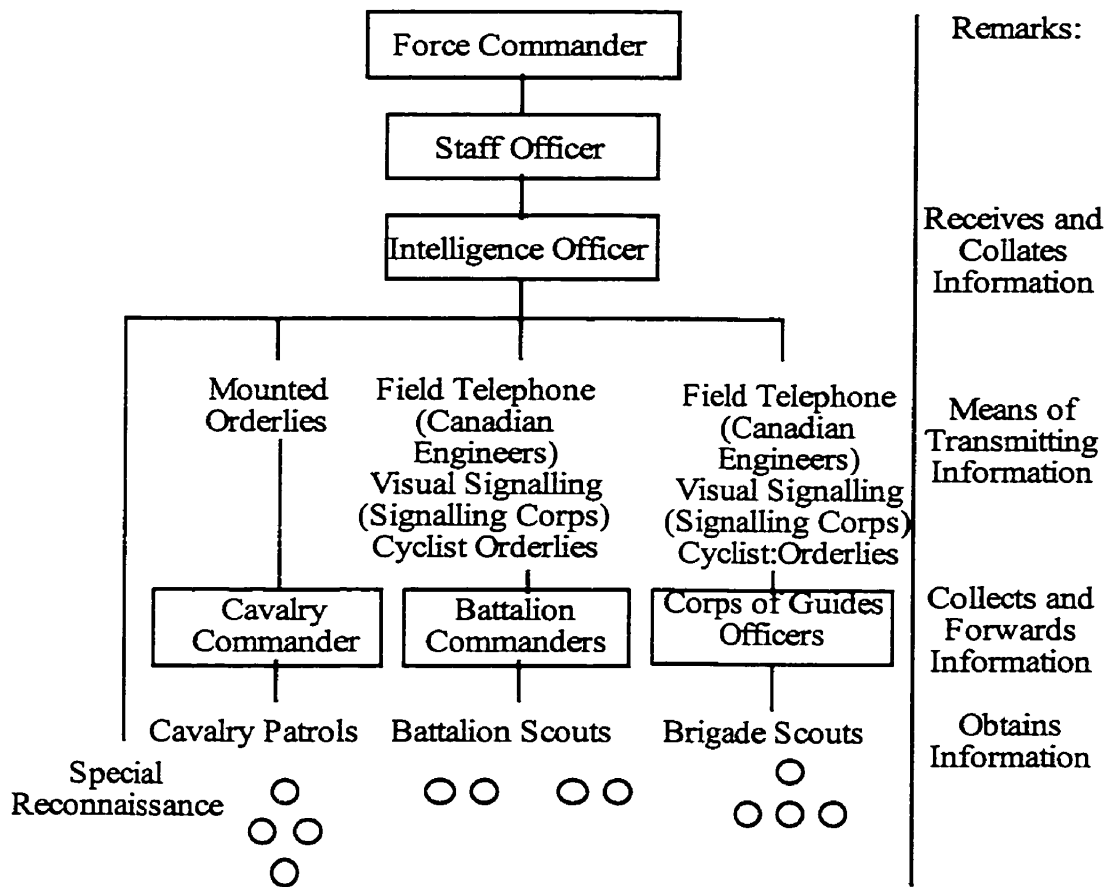

Based on diagram by Major C.H. Mitchell, 1911. NAC, R.G. 24, Vol. 6526, Folder: H.Q. 493 - 1 - 1

the cavalry and infantry scouts -- who were mounted on bicycles and motorcycles -- were "The chief medium for obtaining information." Brigade scouts, under the control of officers of the Corps of Guides, were "thrown out early...and...were able to remain much longer than the cavalry in front" gathering much needed information.³³ The dragoons attempted to locate the enemy's flanks, determine his strength, and the direction of their movement, and other similar operational and tactical details. And although Mitchell, one of the intelligence officers who took part, was not entirely satisfied with the scouts' performance, the experiences gained convinced militia headquarters of the need to raise a complement of scouts for the guide organization; the next year the Corps of Guides received its guides.³⁴

In spite of its problems, the Corps of Guides played a useful role during the prewar years, even though when war came in August 1914, the corps did not serve overseas. The BEF did not have a Guide organization, so the Canadian Corps of Guides was not required. Some 235 of the 499 members did, though, volunteer for the 1st Canadian Contingent. These men were distributed throughout the formation performing various staff functions, including intelligence work. The 11th Detachment of the Corps of Guides operating in British Columbia was the only unit placed on active duty, and it helped guard the coast.³⁵ Although training in the Corps of Guides anticipated a war of movement, many of the skills taught were portable to the mud of Flanders. Indeed, by keeping the importance of battlefield intelligence before the eyes of Canadian soldiers in the years prior to the war, the corps' existence may account for the Canadian penchant for intelligence

³³ NAC, R.G. 24, Vol. 6526, Folder H.Q. 493-1-1. Major C.H. Mitchell to General Staff Officer, 2nd Division, November 10, 1911.

³⁴ NAC, R.G. 24, Vol. 6526, Folder H.Q. 493-1-1. Captain Lawrence Hurt Sitwell, Assistant-Director of Military Intelligence, to Lieutenant Colonel George Paley, Officer Administering the Corps of Guides, November 23, 1911. Also R.G. 9 II B3, Vol. 67: *General Orders, 1912*, General Orders: 23 and 24.

³⁵ S.R. Elliot, *Scarlet to Green. A History of Intelligence in the Canadian Army 1903 - 1963* (Toronto: Canadian Intelligence and Security Association, 1981), 22.

during the war, and may explain why Canadian formations tended to employ more officers on intelligence duties than their British counterparts.³⁶

When the Empire went to war in the summer of 1914, the training that the Canadians of the 1st Contingent received differed little from prewar days. Lessons learned by the British at the front were slow to arrive in training camps, as the imperial troops were preoccupied with the survival of their 'contemptible little army.' Certainly the trenches were a novelty, but most believed that as soon as the trench lines were broken in the next big push, normal manoeuvre warfare would resume. Training for open warfare continued unabated. Tactical exercises held by the Canadians when training in England during the fall and winter of 1914 - 1915, proceeded as if accurate and rapid firing guns, machine-guns, airplanes and trenches did not exist, or at least only played a limited role on the battlefield. Major Victor Odlum, the senior major in the 7th Canadian Battalion, remembered that the routine of the trenches in early 1915 was "far removed from anything experienced in training camps in Canada or England."³⁷ Instead of practicing the methods of trench warfare, encounter battles were conducted.³⁸ Prewar intelligence techniques, when practiced, were the order of the day.³⁹ Training with aircraft for intelligence purposes was practically non-existent. In total, aerial observation was employed by

³⁶ See discussion beginning on page 47. Also, Arthur Currie, "Historical Resume of Canadian Corps Intelligence," in J.E. Hahn, *The Intelligence Service Within the Canadian Corps 1914-1918* (Toronto: Macmillan Company of Canada, Limited, 1930), xv.

³⁷ NAC, M.G. 30 E300 (Odlum Papers) Vol. 16, Folder: The Landing at St. Nazaire February-March 1915. Odlum's monograph.

³⁸ NAC, R.G. 9, Vol. 4056, Folder 32, File 2. See for example the Training Exercise Operation Order No. 2, by Lieutenant Colonel George Tuxford, commanding the Red Force, December 4, 1914. The various unit war diaries also describe training conducted for open warfare.

³⁹ NAC, M.G. 30 E84 (R.G.E. Leckie Papers) Folder B: Reports and Orders 1914 - 1916. Even in the summer of 1915, exercises in encounter battles were normal, and trench training minimal. See M.G. 30 E241 (Macintyre Papers) Vol. 1. Various diary entries, August and September 1915; also, D.E. Macintyre, *Canada at Vimy* (Peter Martin Associates Ltd., 1967), 11 - 15.

only four batteries practicing their gunnery between January 21-28, 1915.⁴⁰ The Canadians did not even fire their batteries until the end of January 1915, and then only fifty rounds (two weeks later they were in France). Artillerymen did not learn about the intelligence gathering techniques necessary for waging trench warfare, but concentrated on driving, equitation, ranging, fire discipline, entrenching and camouflaging.⁴¹ Captain Harry Crerar, who rose to prominence in the Second World War as commander of the Canadian Army, wrote that training in January 1915 consisted of “Grooming horses -- exercising horses -- inspecting horses -- thus our days go by.”⁴² The artillery’s combat role, and the part played by artillery intelligence, was ill-defined.⁴³

Canadian divisional and infantry brigade establishments, however, did recognize the need for intelligence specialists. From their inception Canadian divisions and brigades differed from their British equivalents in that they possessed an extra officer specifically assigned to intelligence duties. British divisions, for example, had only one general staff officer, third grade (GSO3); a Canadian division had two, one of whom, the GSO3(I), the junior of the two, was assigned to intelligence work on a full time basis -- the ‘I’ standing for intelligence -- and was, theoretically, responsible for implementing the division’s intelligence policy.⁴⁴ In a British division tactical intelligence was assigned to the GSO3 as well, but on a part-time basis; the British GSO3 had “to do a fair share of operations work” besides, as remarked upon by Brigadier-General John Charteris, head of

⁴⁰ A. Fortescue Duguid, *Official History of The Canadian Forces in The Great War 1914 - 1919*, Vol. 1 (Ottawa: King’s Printer, 1938), 132 - 133.

⁴¹ Nicholson, *Gunners*, 204.

⁴² NAC, M.G. 30 E157 (Crerar Papers) Vol. 15. Diary entry January 16, 1915.

⁴³ Nicholson, *Gunners*, 204, 209-210; J.A. Swettenham, *McNaughton, Vol. 1, 1887 - 1939* (Toronto: Ryerson Press, 1968), 37; Shelford Bidwell and Dominick Graham, *Fire-Power. British Front line Weapons and Theories of War 1904 - 1945* (London: George Allen & Unwin, 1982), 19-20.

⁴⁴ Duguid, *Official History*, 147. In addition to the GSO3s, each Canadian division also had two GSO2s and a GSO1.

intelligence at GHQ, in 1916.⁴⁵ Similarly, British brigades had only one staff captain. Canadian brigades had two, one of whom was the staff captain(I) who, theoretically, oversaw brigade intelligence. In a British brigade intelligence fell to the brigade major, a man already burdened with a great many other duties.⁴⁶ General Currie, who during the war rose to command the Canadian Corps, thought that the extra officers in Canadian formations strengthened the intelligence service and “formed the basis of the success which attended the development of Intelligence generally throughout the Canadian Corps.”⁴⁷

In the 1st Canadian Contingent the training of intelligence officers in their combat role was sporadic at best. In 1914 and early 1915, for instance, the training received by Lt. Col. Mitchell, appointed in October 1914 to the 1st Canadian Contingent as GSO3(I), was limited by the fact that the contingent did not normally train as a body. Instead, its component parts trained separately (companies for five weeks, battalions for two and brigades for two). Moreover, rain fell on 89 of the 123 days the 1st Contingent was in England, severely disrupting training programs. This meant that Mitchell had largely to invent his combat intelligence role from a theoretical standpoint, and from his prewar experiences in the Canadian Corps of Guides. In all probability he likely expected his combat role to follow the lines of the 1911 Thanksgiving Day tactical exercise in which he acted as one of the opposing force’s intelligence officers.

While stationed in England in 1914 and 1915, however, Mitchell managed

⁴⁵ NAC, R.G. 9 III C3, Vol. 4104, Folder 16, File 3. “Lecture on Intelligence,” by Brigadier-General J. Charteris, February 4, 1916.

⁴⁶ Duguid, *Official History*, 148. NAC, M.G. 30 E61 (Mitchell Papers) Vol. 14, Folder 92. “Instructions Regarding Intelligence Duties, 2nd Army,” October 1915. This document admits intelligence was part-time in British commands. It reads in part: “In Brigades, and even Divisions, it is seldom possible to detail an officer of the General Staff for purely intelligence duties, but the collection and forwarding of intelligence will be a recognized part of one officer’s duty on both staffs.”

⁴⁷ Currie, “Historical Resume,” xv.

to keep himself occupied. Reviewing tactical exercises and evaluating the performance of the scouts and cavalry as regards to their intelligence gathering capabilities was one area to which he no doubt applied himself. His prewar training in the Canadian Corps of Guides, after all, gave him some expertise in practical scout training and intelligence. Nothing in the records, however, shows what his observations, if any, may have been. He also probably obtained and distributed front line reports on the nature of the fighting. A series of publications entitled *Notes From the Front* offers an example. These, and other reports, contained practical information about trench fighting, tactics and other lessons learned by the British forces already engaged. Such information was invaluable for acquainting Canadian greenhorns with front line conditions, but little direct advice was given on the intelligence function. However, topics such as camouflage, artillery observation, enemy ruses and espionage were discussed, and surely aided Mitchell in his efforts to understand his field role.

In addition, Mitchell, along with other officers and men, took part in lectures given by returning British officers. Lecturers spoke about the difficulties of trench fighting, wire cutting, digging proper trenches, reliefs, offensive and defensive techniques employed at the front, reserves, concealment, and a host of other topics. In the few lecture notes from early 1915 discovered in the National Archives, there was little focus on the 'how to's' of intelligence gathering; although one officer did state that he was "hard at work training 'snipers' and Scouts" in his "spare time," as "They are good value I think." Clearly, this was not a resounding endorsement of the need for skilled front line intelligence gatherers, but it was a start.⁴⁸ One of Mitchell's own lectures dealt with the composition and

⁴⁸ NAC, M.G. 30 E61 (Mitchell Papers) Vol. 16, Folder: Western Front, Orders and Instructions, 1914 - 1915. Lecture by Major-General McCracken, January 8, 1915. Also R.G. 9 II C3, Vol. 4217, Folder 7, File 19. "Notes From an Officer Commanding a British Regiment at the Front (A Very Practical C.O.)," February 3, 1915.

strength of the German Army, the quality of its fighting men, and the value of combat intelligence in general. His belief that willpower could overcome material considerations was typical of many officers of the day, as was his view that German soldiers were mindless machines. He wrote:

[The Germans possess] the greatest and most perfectly organized Army in the world; but battles are not won solely by numbers and organization, or material and discipline. Individual initiative, capacity to endure hardship, and determination to win through, are still required.

German life and system is not designed to encourage individual effort, but to reduce soldiers to disciplined automatons. [The] German Army is obedient to explicit rules, precise for all situations. But things do not always happen as planned and frequently go awry. The German soldier is then at a loss to carry on. His nature and training are oppose to it, and the personal factor of initiative is wanting.

It has been said that the German Infantryman lacks the dash of the French, the doggedness of the Russian, and the adaptability of the British.⁴⁹

This was an arrogance that would not last. Stereotyping an opponent in this way is the enemy of good intelligence, as there is a danger to read information in light of the typecasting, and not necessarily for what it truly represents.

Spy mania was rampant in the early days of the war, and it was one of Mitchell's tasks while in England to root out suspicious characters from the division's ranks. Many believed that Canada and the other British colonies offered ideal entry points for German sympathizers, nationals and spies to enlist in the British service and engage in subversion from within. Intelligence and other officers spent a great deal of time checking the backgrounds of volunteers who behaved strangely or had German sounding names. At this stage of the war the army was no place for eccentric or odd-acting individuals. The 5th Battalion diarist

⁴⁹ NAC, R.G. 9 III D3, Vol. 4823, 1st Division War Diary, January 1915, Appendix Seven. "The German Army," a lecture by C.H. Mitchell.

noted on October 31, 1914, that the efforts of the intelligence officer reviewing the members of his battalion were well worth it. The intelligence officer's "principal duty has been in getting information regarding German suspects and spies," noted the diarist, "and from the information gathered, this appointment has been warranted, as there is no question that we have several men whose correspondence and actions are very suspicious."⁵⁰ Each contingent that arrived in England from Canada underwent the same kind of scrutiny. A November 1915 memorandum stated:

Every man alien born or of alien stock now in camp [in England] or who may come in by any of the drafts from Canada, should be listed and carefully investigated. Most of them are of course quite innocent.

To avoid raising suspicion against any particular individual, intelligence officers interviewed all such aliens, with each soldier told the reasons for the examination at the outset. They were also told that it was a routine procedure for detecting those who might prove disloyal, and that they were not under any special suspicion. "Each man," in fact, "should be dismissed [from the interview] feeling that he is quite free of suspicion. If he be wrong he will be emboldened, and will be the easier detected."⁵¹

Brigade intelligence officers were similarly ill-prepared for their combat intelligence role, although all brigade intelligence officers in the 1st Contingent had served with the Corps of Guides before the outbreak of hostilities. However, without battlefield experience to hang their training on it was very difficult for them

⁵⁰ NAC, R.G. 9 III D3, Vol. 4916, 5th Battalion War Diary, October 31, 1914. Similar coverage of suspicious characters can be found in M.G. 30 E61 (Mitchell Papers) Vol. 8, Folder 35; R.G. 24, Vol. 1840, Folder: GAQ 10-31, and R.G. 24, Vol. 1861, Folder 64. Cummin's Monographs WWI, "Intelligence in the Field."

⁵¹ NAC, R.G. 9 III C3, Vol. 4198, Folder 3, File 14. Headquarters, Canadian Troops, Bramshott Camp to 58th Battalion, November 26, 1915.

to appreciate the hardships they would face in the trenches. The uncertainty of their role was compounded by the organization structure of the brigade. As Figure 2.3: "Brigade Intelligence Organization" illustrates, staff captains(I) served two masters: their brigades' brigade major and its senior staff captain. When performing administrative duties they reported to the senior staff captain; when acting in an intelligence capacity they reported to the brigade major, or the brigade commander if the information was urgent. They were also supposed to keep the divisional intelligence officer informed of developments in the brigade. Consequently, staff captains(I) were only part-time intelligence officers, it obviously being believed that intelligence duties would not occupy their full attention. This was certainly an improvement over the British brigade organization in that the staff captains(I) gave each Canadian brigade an extra officer to help with the intelligence workload once it did finally arrive. The divided nature of the staff captains'(I) role in the brigade organization reflects to some degree just how valuable, or valueless, the army perceived their role to be. Staff captains(I) were paid less than the senior staff captains and, in 1916, after the value of combat intelligence had been clearly demonstrated, this remained the case.⁵²

Staff captains(I) received minimal training while stationed in England, and carried out a great deal of non-intelligence administrative work. It was a big job training and organizing a brigade from scratch, and both brigade staff captains were fully employed with administrative tasks. In any event, there was little time or need for the employment of brigade intelligence officers, with the exception of their aiding the divisional intelligence officer in his quest for undesirable elements in the

⁵² NAC, R.G. 9 III C3, Vol. 4104, Folder 16, File 3. Letter by Brigadier-General R. Rennie, commander of the 4th Brigade, recommending that the two staff captains in a brigade be paid the same, as the work load was equal, May 9, 1916. I did not learn if staff captains(I) received a pay raise.

Figure 2.3: Brigade Intelligence Organization⁵³

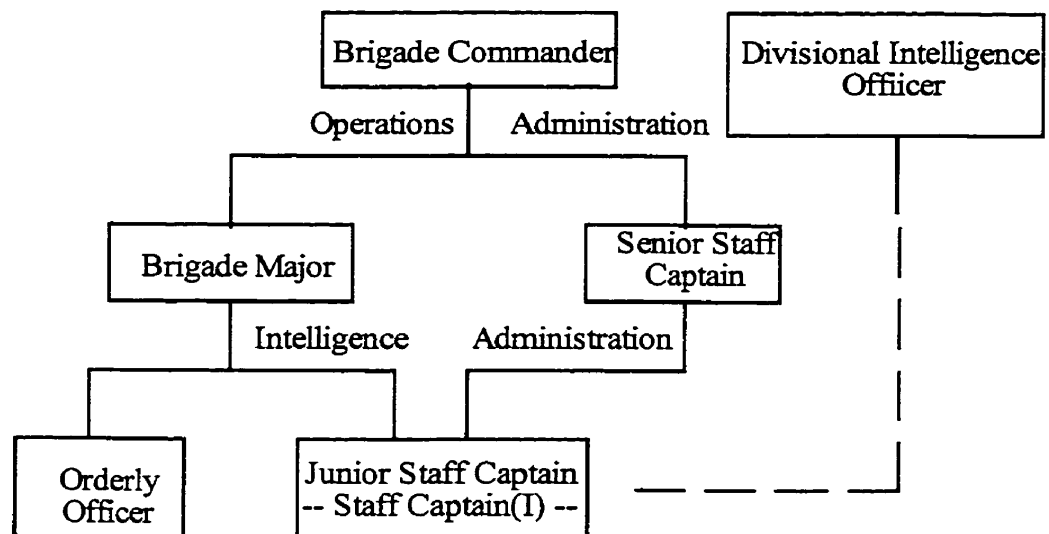

⁵³ NAC, R.G. 9 III C3, Vol. 4056, Folder 32, File 10. The diagram is based on one found in a letter written by the 2nd Brigade commander to the 5th and 6th Battalions, October 1, 1914.

formation. During the tactical exercises on Salisbury Plain in 1914 and early 1915, it was unclear what they were to do in their intelligence capacity. They had no staff to help them, nor did they command any independent sources of information. Brigade commanders, or their brigade majors, could just as easily receive and interpret reports from the front as staff captains(I). They must have wondered if they were simply filling a redundant position.

On the whole, it was easy for all concerned to neglect brigade intelligence functions. As a result, staff captains(I) became catch-all officers who likely had little idea what their first priority was -- intelligence or administrative work. Captain Ross Napier, the staff captain(I) for the 2nd Brigade, offers a case in point. While his brigade was in England he was responsible for numerous duties in addition to his intelligence role, which largely consisted of identifying and investigating suspicious characters. At one time or another he acted as the brigade's duty officer, wrote and posted the brigade's daily orders, and dealt with various administrative problems. At times he had his hand in equipment procurement, ammunition supply, clothing matters, stores of all kinds and sundry medical administrative details. In November 1914, he reviewed the sanitary conditions of battalions in the brigade. Quoting from the medical officer's report, Napier informed battalion commanders that the "Majority of tents contain refuse from meals and are rarely cleaned." He noted how "Few of the Battalions have brooms or rakes to clear them with." He complained that latrines were "imperfectly screened," that the surrounding ground was fouled and there was "a large amount of paper blowing about." In December, he helped with the meningitis outbreak in camp, and the discharge of soldiers for misconduct or medical reasons.⁵⁴ With all these concerns facing him it is hard to see how he could have devoted much time to

⁵⁴ NAC, M.G. 30 E75 (Urquhart Papers) Vol. 2, Folder 3. Napier to units, November 23, 1914; December 3, 1914; December 28, 1914; R.G. 9 III C3, Vol. 4056, Folder 32, File 10. 2nd Brigade to 5th and 6th Battalions, October 1, 1914.

his intelligence duties. Since there were only two weeks scheduled for brigade training to begin with -- far too short a period to become proficient -- his understanding of his combat role could not possibly have been entirely clear in his mind, even with his prewar experience in the Corps of Guides. Also, as with Mitchell, rain interfered with his training.

At the battalion level of command there were no intelligence officers *per se*. Battalion commanders, their senior majors, and company commanders acted as their own intelligence officers. Each battalion also had sixteen scouts and four scout non-commissioned officers (NCOs). These were divided evenly amongst the four companies in a battalion, meaning each company had four scouts and one scout NCO to assist in gathering information. Before proceeding to France, however, divisional headquarters instructed its battalions to have additional scouts trained as replacements for any who became casualties. Battalion scout officers, whose job it was to oversee battalion intelligence, did not exist at this time, although for training purposes battalions regularly withdrew their scouts from their companies and collected them together under an officer referred to as a scout officer. This was not a permanent position, though, as the scouts returned to their companies once the training sessions ended. Therefore, these officers should not be confused with the scout officers introduced to battalions at the end of 1915, and who commanded battalion level intelligence sections whose sole duty centred on battalion intelligence. As for training, battalion scouts prepared for war as they always had. November 1914, for example, saw scouts from the 5th Battalion carrying out physical training, semaphore signalling, sketching, message writing, distance judging, map reading, compass work, and night work. They also attended lectures that included the study of French and first aid.⁵⁵ All in all, their training gave them some basic skills, but did not by any stretch fully prepare them for trench warfare.

⁵⁵ NAC, R.G. 9 III C3, Vol. 4057, Folder 35, File 3. Training syllabuses.

Non-scouts, for their part, learned little in the way of battlefield intelligence. Trench digging, physical fitness, musketry, and bayonet practice were the staples of infantry instruction. The volume of information available and necessary in siege warfare was simply not anticipated in the encounter battles rehearsed by Canadian battalions training in England in 1914 and 1915.

Realistically, when the 1st Canadian Division arrived in France in February 1915, it did not possess an intelligence service manned by fully trained intelligence experts devoted to unearthing the enemy's tactical secrets. There were intelligence officers, but their roles were ill-defined; and there were scouts and cavalry, but they had not trained for trench warfare. With trench warfare the need for tactical intelligence was acute. The amount of information, and the detail demanded by commanders and their staffs, was unprecedented. The Canadians were unprepared for this quantitative and qualitative shift, and entered the war with an approach to intelligence anchored in nineteenth century and Boer War practices. The Canadians thought intelligence would be gathered in the tradition of past wars, and was a low priority in their training syllabuses. Indeed, the intelligence officer as he then existed occupied a position of little consequence. It is interesting to note that histories of Canada's military contribution invariably point out that British officers occupied what were considered the most important and senior staff appointments in the CEF; however, intelligence positions were not one of them, as Canadians could always fill these posts.

CHAPTER THREE

EARLY INTELLIGENCE GATHERING

When the men of the 1st Canadian Division arrived in France they had little appreciation for the complexity of the intelligence demands that were about to be placed upon them by a modern, industrial, trench war. It was not long, however, before they realized that their training had not fully prepared them for the exigencies of the front. In the previous chapter, for example, we saw how Major Victor Odlum of the 7th Battalion remembered his initiation into the trenches as being “far removed from anything experienced in training camps in Canada or England.” Captain D.E. Macintyre, an officer in the 28th Battalion, when commenting on his first time in the line in September 1915, said: “The truth of the matter is that we hardly knew what to do with them [the scouts], as the employment of Scouts in trench warfare was a subject on which we could get little or no information in England. As for the whole Battalion not one of us had ever been in a trench before and knew nothing of the business.” Private Donald Fraser, of the 31st Battalion, recalled in his diary-memoirs: “When I think of it, our training was decidedly amateurish and impractical.”¹ Manoeuvre and encounter battles, for which the Canadians had trained, were no more. The opposing forces had settled down into

¹ National Archives of Canada (NAC), Manuscript Group (M.G.) 30 E300 (Odlum Papers) Vol. 16, Folder: The Landing at St. Nazaire Feb.-March 1915. Odlum’s monograph; M.G. 30 E241 (Macintyre Papers) Vol. 1. Macintyre’s Diary, September 25, 1915; Private Fraser, *The Journal of Private Fraser, Canadian Expeditionary Force*, ed. R.H. Roy (Victoria, B.C.: Sono Nis Press, 1985), 23; Fortescue Duguid, *Official History of The Canadian Forces in The Great War 1914 - 1919*, Vol. 1 (Ottawa: King’s Printer, 1938), 176.

siege warfare. Field intelligence was no longer a question of locating the enemy and determining the whereabouts of his flanks, one already knew, generally speaking, where these were. Intelligence was now concerned with establishing and tracking the German order of battle, and with securing previously unimagined tactical detail on the enemy's position. Many of the methods used by intelligence gatherers to gain such intimacy, if not entirely new to warfare, were sometimes radically different in practice from what had been expected; and before the Canadians had a hope of defeating the Germans, they had to master these techniques. It was only then that they could build profiles of the enemy lines, learn their nuances, and form plans to defeat them.

The learning process began on February 17, 1915, when soldiers from the 1st Canadian Division saw the front for the first time. The officers and men were attached to British divisions for one-on-one instruction in the techniques of trench warfare. "Every man, from company commander down to private, spent forty-eight hours with his opposite number for individual training -- [it was] a thorough introduction to the mysteries of trench warfare."² Over a period of two weeks the entire division received its indoctrination. The infantry instruction included lectures, patrolling, listening post work, the study of enemy habits, sentry duty and various survival techniques. Platoons held their own section of trench under British guidance.³ Canadian intelligence officers, the divisional GSO3(I) and the

² John Swettenham, *Canada and the First World War* (Ottawa: Canadian War Museum), 5-6.

³ W.W. Murray, *The History of the 2nd Canadian Battalion (Eastern Ontario Regiment) Canadian Expeditionary Force in the Great War, 1914 - 1918* (Ottawa: Mortimer Ltd., 1947), 24, 27. R.C. Fetherstonhaugh, ed., *The Royal Montreal Regiment, 14th Battalion, C.E.F., 1914 - 1925* (Montreal: The Gazette Printing Co. Limited, 1927), 28. G.W.L. Nicholson, *The Gunners of Canada. A History of the Royal Regiment of Canadian Artillery, Vol. 1, 1534 - 1919* (Toronto: McClelland & Stewart, 1967), 208.

brigade staff captains(I), did not have clear equivalents in British commands with whom to train, but it seems likely that the Canadian GSO3(I) hooked-up with the British GSO3 to learn his intelligence role when that British officer was not discussing operational concerns with other Canadian staff officers. The staff captains(I) at brigade no doubt learned their administrative duties from British staff captains, and something of their intelligence role from British brigade majors, although nothing uncovered in the records verifies these assumptions. What does seem likely given the part-time nature of intelligence staff work in British formations is that the Canadian GSO3(I) and the Canadian staff captains(I) received only limited instruction in their combat intelligence duties. Over the next several months the Canadians honed the British-taught techniques, so dearly learned during the previous autumn and winter.

Figure 3.1, “Front-line Combat Intelligence Sources in the 1st Canadian Division, Early 1915,” illustrates something of the extent of intelligence sources available to the Canadian command along its front. Notably absent from the figure is any indication of an intelligence role for cavalry. Mounted troops were, by and large, not employed during trench warfare in their traditional capacity and, therefore, played a minimal part in amassing knowledge on the German positions. The cavalry’s day had ended. On the other hand, the inclusion in Figure 3.1 of an artillery and an aerial contribution to intelligence collection recognizes their emergence as important sources.

Trench warfare gave the artillery an opportunity to develop its own information sources independent of the infantry, the Royal Flying Corps (RFC), and the cavalry. Since guns now rested for weeks on end in the same spot, gunners now had the time to collect their own intelligence. Instead of being mere recipients of news acquired by others, the artillery became one of the suppliers, and there were a number of sources that the gunners controlled. Artillery observation

Figure 3.1: Front-line Combat Intelligence Sources in the 1st Canadian Division, Early 1915

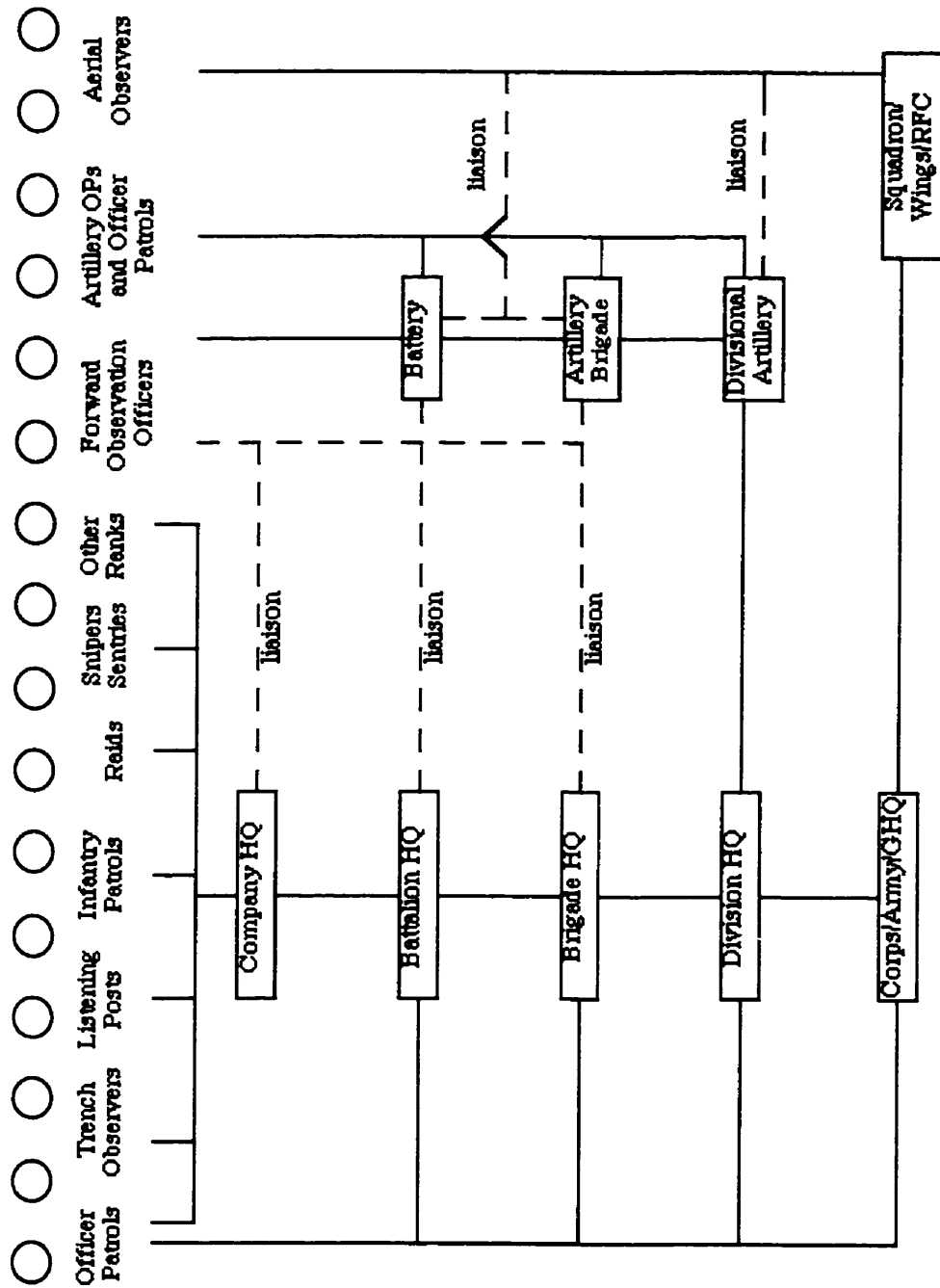

posts (OPs) were one. These posts, constructed behind the front lines on commanding terrain, were an early and valued source of intelligence, and remained so throughout the war. OPs were occupied by officers, usually battery commanders or trusted subordinates, along with some signallers. Telephones normally connected them to the gunners, although early in the war there were occasions when the telephone link was not made.⁴ Well positioned artillery OPs offered artillery officers a wide view of the front, and granted observers the opportunity to search out targets in the rear of the enemy's front line. Since trench warfare bestowed on the artillery the luxury of time, gunnery officers could now thoroughly reconnoitre a position from an OP and gain a more immediate feel for the infantry's position and determine how best to assist.⁵ Opportunity targets could also be engaged, providing the observer reported their positions forthwith, something that did not always happen.⁶ Infantry officers also visited these posts to survey the front, observe the ongoing siege, and to maintain regular contact with the gunners, thereby fostering mutual understanding and cooperation.

Artillery patrols further augmented the information received at artillery headquarters. These were fact finding missions composed of an officer or two, accompanied by perhaps two or three men. They were used to reconnoitre the front, and to come to an understanding of the infantry's position and the general tactical situation. In some instances, early in the war, such patrols were the only

⁴ NAC, Record Group (R.G.) 9 III C3, Vol. 4144, Folder 1, File 4. 3rd Division to artillery brigades, April 13, 1918. It was pointed out in this letter that observing officers control the artillery fire for at least part of the time, and so should not be inexperienced or junior officers. Ideally, the battery commander himself was at the OP. The fact that telephone links were not always made reflected British expectations for a mobile war; they went to France with too little telephone cable. The shortage was made worse as the British Army increased in size. Much equipment was also lost in the retreat from Mons.

⁵ NAC, R.G. 24, Vol. 22,015. "Notes From the Front, Part I," 1914, page 17. "Notes From the Front, Part III," February 1915, page 27.

⁶ NAC, R.G. 9 III C3, Vol. 4098, Folder 43, File 1. Canadian Corps to divisions, July 18, 1916.

means by which the artillery could locate enemy and friendly positions. At one point on April 22, 1915, for example, during the Second Battle of Ypres, the 10th Battery found itself the only organized force remaining between the Germans and the town of St. Julien after the Germans had swept away the other defenders. On that occasion the 10th Battery utilized patrols to confirm the presence of enemy troops supposedly operating nearby on its flanks. After confirming the veracity of these reports the battery commander reversed “two of [his] guns, [and] opened fire on them [the Germans] at about 200 yds.” A second patrol brought back word that the enemy had retired.⁷

Forward observation officers (FOOs) were another early and trusted source of information for the artillery. This was because in 1914 and 1915, scientific gunnery practices had not yet progressed to a stage where accurate unobserved fire was possible.⁸ The solidification of the lines and the range of modern weapons forced the artillery further and further away from the front, and to points where enemy gun positions were typically out of the gunners' direct line of sight. Forward observation officers acting as the battery commanders' forward eyes monitored the fall of shot and called in corrections. They also notified the gunners of massing German troops and other movements, and were a good source of tactical information. FOOs were usually subalterns who, along with signallers and other personnel working with them, occupied observation posts forward of the guns that gave them a direct view of the enemy line. Often these OPs were situated in the infantry trenches, sometimes they were in trees or buildings. Being artillery officers, FOOs knew what information the gunners required for accurate and timely shelling, and since they knew the gunners' language they knew how to report their

⁷ NAC, M.G. 30 E6 (Burstall Papers) Vol. 3, File 17. Commander of the 10th Battery to the 3rd Canadian Artillery Brigade, May 10, 1915.

⁸ A.F. Brooke, “The Evolution of Artillery in the Great War, Part II,” *Journal of the Royal Artillery* 51.6 (January 1925): 367, 370.

findings in an intelligible way. They also supplied the infantry with information, thus forming an important intelligence conduit between the two service arms.⁹ One shortcoming, however, was their limited view of the front. FOOs could not see much beyond the enemy's front line positions, and sometimes missed a great deal. Even as late as October 1918, the commander of the 5th Field Artillery Brigade complained that FOOs failed to notice large movements of enemy troops. The commander was ashamed that it was the infantry who informed the artillery of these targets, and regarded this as a slap in the face to unit pride. "It is not understood why the Infantry should tell us our job," he wrote. He attributed the FOOs' failure to the influx of inexperienced officers, and to the fact that FOOs "have become slack." Needless to say, the commander did not want this to continue.¹⁰ A second limitation lay with communications. Enemy shelling easily severed telephone lines, cutting communications to the gunners (later in the war when wireless transmission was more widely available this was not such a problem, although wireless did not answer all the FOO and artillery needs). FOOs, being close to the action, might also become casualties, or incapacitated, and not be able to contact their guns. Observed enemy targets might then go unscathed. Furthermore, when FOOs were absent from their OPs the infantry lost this link to their supporting guns, and the artillery lost this pair of eyes.¹¹ Beginning with the Battle of Festubert in May 1915, however, FOOs began accompanying the infantry in the advance, helping to ensure that supporting guns had up to date information on the infantry's progress

⁹ NAC, R.G. 24, Vol. 22,015. "Notes From the Front, Part I," 1914, pages 7 and 16; "Notes From the Front, Part II," 1914, page 5. "Notes From the Front, Part III," February 1915, page 28.

¹⁰ NAC, R.G. 9 III C4, Vol. 4299, Folder 5, File 4. Commander 5th Artillery Brigade to Batteries, October 3, 1918.

¹¹ This happened during the Second Battle of Ypres, when FOOs for the 5th and 6th Batteries left the headquarters of the 5th Infantry Battalion and rejoined their guns, and never returned. See NAC, R.G. 9 III D3, Vol. 4916. 5th Battalion War Diary, April 1915.

and needs.¹² FOOs were supposed to work closely with the infantry, and vice versa, and together “work out a system for taking on favourable targets as soon as they appear.”¹³ As such, throughout the war, FOOs remained a valued source of tactical information, although their value as a source of counter battery intelligence declined once more reliable sources, such as sound ranging, flash spotting, and aerial reconnaissance were developed.¹⁴ Where they remained useful, though, was in correcting fire, and for calling down shot on enemy counter attacking forces and other targets of opportunity.

Various other liaison arrangements secured for the artillery information generated by the infantry. It was only through close liaison and cooperation that combat intelligence gathered by one arm could be best put to use by the others. Telephones normally connected the artillery to the infantry, and it came to pass that artillery and infantry headquarters were placed in close proximity to each other whenever possible. Moreover, artillery officers often viewed the front from the infantry trenches, while the infantry did likewise from artillery posts.¹⁵ Artillery liaison officers (LOs) working with the infantry also smoothed the exchange of information. A July 1916 notice from the 11th Canadian Infantry Brigade to its subordinate units noted that close liaison was crucial to commanders in the field. It stated that artillery liaison officers should be stationed with all battalions then in the front line; that these LOs should live close to the battalion commanders, and preferably “mess together.” This was done in order to develop a better understanding of each other’s difficulties and to “ensure the elimination of all

¹² Duguid, *Official History*, 487.

¹³ NAC, R.G. 9 III C3, Vol. 4098, Folder 43, File 1. 2nd Division to artillery brigades, July 18, 1916.

¹⁴ NAC, R.G. 24, Vol. 1832, Folder GAQ. 8-15e. “Organization and Procedure of Counter Battery Office Canadian Corps Artillery,” January 25, 1919.

¹⁵ NAC, M.G. 30 E241 (Macintyre Papers) Vol. 1. Diary, October and December 1915, and March 1916.

friction and the reduction of queries that have to be sent to [Brigade] H.Q.”¹⁶

Likewise, in January 1917, the 3rd Brigade noted that

The Artillery Group Commander is very desirous that as many as possible of the officers of the two branches [infantry and artillery] get to know each other, with a view to better understanding and closer co-operation in the future. Each Battalion in the line has with it an artillery Liaison Officer, who sleeps at Battalion Headquarters...They render daily Intelligence Reports to their Group Commander. There should be a free exchange of intelligence and information obtained through either infantry or artillery sources.¹⁷

Liaison officers, in other words, acted as “the ‘forward ears’ of the Commanders who [sent] them out and with whom they must maintain close touch.” It was their job to ensure the smooth exchange of information between the infantry and their supporting guns, and to see that the infantry were happy with the support received. And as one memorandum stated: “*All Liaison Officers* must appreciate...that it is their duty and privilege to act as advisers on all Artillery matters to the [infantry] Commanders to whom they are attached.” It went on to say “that the success of operations largely depends on the accuracy of information and the speed with which this information is passed to the Commanders in rear, and that they have unequalled opportunities of collecting information” from the infantry. At the same time the infantry were reminded that “it takes two to form a liaison,” and were to give their full assistance to the artillery liaison officers.¹⁸ This meant that the various infantry commands, to get the most out of their supporting guns, had to share knowledge of front line conditions with the LOs so that the LOs, in turn, could instruct the

¹⁶ NAC, M.G. 30 E300 (Odlum Papers) Vol. 24, Folder: Trench Discipline and Organization March 1916 - April 1918. 11th Brigade to Battalions, July 28, 1916.

¹⁷ NAC, R.G. 9 III C3, Vol. 4076, Folder 2, File 21. 3rd Brigade to battalions, January 28, 1917.

¹⁸ NAC, R.G. 9 III C4, Vol. 4248, Folder 13, File 9. “Duties of Observing Officers, F.O.O’s., Liaison Officers and Forward Liaison Officers,” April 2, 1917.

gunners as to the infantry's needs.¹⁹ Such close cooperation ensured that LOs remained a valued conduit for information exchange throughout the war.

Corps cohesion and operational planning benefited from the sharing of intelligence. However, it took time to build a working relationship between the gunners and the infantry. The problem was that early in the war neither really understood the needs and limitations of the other. Liaison was almost non-existent in the prewar army, and old habits were hard to break once war came. According to the February 1915 *Notes From the Front*, infantrymen calling for artillery assistance sometimes gave vague reports. On one occasion an infantry NCO could not even supply his own location, yet he expected artillery assistance. The artillery required specific compass bearings, ranges, and map references, but the infantry did not always supply them. A description of the target was always useful, yet not always provided. Artillerymen also felt that the infantry called for unwarranted artillery support.²⁰ This was especially the case in 1915, when it must have seemed to the infantry that husbanding ammunition was more important than engaging the enemy. In fact, the preservation of ammunition (in short supply in 1915) did at times come before the needs of the infantry, which tended to limit the value of intelligence received.²¹ Andrew McNaughton wrote after the war:

In those early days the artillery situation was not such to inspire confidence in the minds of our infantry; picture to yourself the case of an infantry officer pointing out to a gunner the location of a nest of German machine guns which are worrying the men in the line. The gunner admits that it is a good target and that he would like to engage it, but -- "No ammunition." The retort of the infantryman was likely to be "What are you doing in the Great War anyway?" and the

¹⁹ NAC, R.G. 9 III C3, Vol. 4144, Folder 1, File 4. 3rd Divisional Artillery to artillery brigades, April 13, 1918.

²⁰ NAC, R.G. 24 Vol. 22,015. "Notes From the Front, Part III," Feb. 1915, page 5. "Notes From the Front, Part IV," May 1915, page 28.

²¹ In 1915, a severe shell shortage meant that gunners were sometimes limited to only three shells per day.

result, if the gunner was a bit touchy, was to impair and discourage liaison.²²

Educating the infantry about the artillery's needs and limitations took time, and was an on-going process. The reverse was also true. In October 1915, Lieutenant Colonel James Reynolds, commanding the Number One Artillery Group, noted that the infantry did not know what targets the artillery supporting them had registered their guns on. To remedy this, he instructed the gunners to tell battalions what targets they had registered, and to advise the infantry when they were about to fire, especially when no forward observers were on duty.²³

During the war's first winter the British developed the SOS mission to aid artillery - infantry cooperation. Under the SOS system a responsible infantry officer in the front lines contacted the artillery for immediate fire support on some prearranged point if he felt his position unduly threatened. He did this over the telephone, or by firing flares or rockets, or by utilizing some other light signal. The artillery responded by firing a pre-planned artillery shoot. The SOS mission was supposed to be used only under urgent conditions, in response to German raids or assaults, but the artillery complained that the infantry relied too much on the SOS bombardment. All threatening movements seemed urgent to those on the receiving end. Nevertheless, the SOS system was used throughout the war, often to great advantage.²⁴

²² A.G.L. McNaughton. "Development of Artillery in the Great War," *Canadian Defence Quarterly* 4 (1929): 162.

²³ NAC, R.G. 9 III C3, Vol. 4140, Folder 1, File 3. Letter by Lieutenant Colonel Reynolds, counter signed by the brigade major, 6th Brigade, and issued to the 31st Battalion, October 19, 1915. Registration is the process of determining the correct targeting information necessary for hitting a target in the future. It requires an observer to call in the necessary adjustments to the fall of shot if the gunners do not have a direct line of sight to the target for themselves.

²⁴ A.F. Brooke, "The Evolution of Artillery in the Great War, Part V," *Journal of the Royal Artillery* 53.1 (April 1926): 79; NAC, R.G. 9 III C3, Vol. 4083, Folder 2, File 5. "First Army Instructions For S.O.S. Signals," February 14, 1917.

Intelligence sharing benefited enormously from the Canadian command's decision to compile and issue a daily divisional Intelligence Summary. The Canadians' first summary was produced on March 12, 1915, roughly one week after they first occupied a portion of trench under their own authority. It helped manage the information reaching divisional headquarters each day from infantry brigades, the divisional artillery, and the corps to which the division was attached. According to General Arthur Currie, the 1st Canadian Division was one of the first divisions in the British Army to issued its own Intelligence Summary.²⁵ The Intelligence Summary contained information on front line conditions across the Canadian front. The divisional intelligence officer issued it at the same time each day to lower level commands, to neighbouring divisions, and to corps headquarters. It began as a one-page summary, printed on both sides of foolscap paper, and detailed the more salient information (mainly of a tactical nature) obtained by the division during the preceding twenty-four hour period. The Intelligence Summary was the Canadian command's first effort to inform systematically officers and select personnel of the more important discoveries made along its front, and it allowed officers to keep their maps and notebooks up to date in a regular, daily, and systematic manner. Since Intelligence Summaries were dated they were easily filed for future reference.²⁶

In addition to their immediate detail, Intelligence Summaries provided a tactical intelligence history of a given sector. By comparing one Intelligence Summary to the next over a period of days and weeks, intelligence and other officers discovered patterns and habits in German activity, while planned

²⁵ Arthur Currie, "Historical Resume of Canadian Corps Intelligence," in J.E. Hahn, *The Intelligence Service Within the Canadian Corps 1914-1918* (Toronto: Macmillan Company of Canada, Limited, 1930), xvi.

²⁶ NAC, R.G. 9 III C3, Vol. 4009, Folder 11, File 4. 1st Canadian Division Intelligence Summary issued on March 12, 1915.

offensives and other movements became easier to detect. Without Intelligence Summaries it would have been far more difficult to notice slight alterations in German activity, especially when changes occurred slowly over several days or weeks, during which time several friendly units might have rotated through that portion of the line. Most importantly, divisional Intelligence Summaries joined the otherwise divergent combat arms together by linking intelligence gathered by one to that collected by others. This helped build a cohesion amongst the Canadians that served them well in the years ahead. As one author pointed out, without Intelligence Summaries “it would have been a very disjointed, disconnected war” effort.²⁷

One problem with Intelligence Summaries, though, was that at first not all divisions compiled them. This meant that when the Canadians entered a new sector, a systematic stockpiling of information might not be available from the division being relieved. The availability of army and corps summaries alleviated this shortcoming somewhat, but army and corps level summaries did not offer the same local detail. Fortunately, many British divisions began preparing Intelligence Summaries by late 1915, although this practice, at least at first, was optional.²⁸

The aerial services added another dimension to intelligence gathering. During the early battles of the war, in 1914, the RFC was more valuable for its

²⁷ Ferdinand Tuohy, *The Secret Corps. A Tale of Intelligence On All Fronts* (London: Murray, 1920), 243. He makes the same point in *The Crater of Mars* (London: William Heinemann Ltd., 1929), 99.

²⁸ NAC, M.G. 30 E61 (Mitchell Papers) Vol. 14, Folder 95. “Instructions for Intelligence Duties, 2nd Army,” March 1916. One section in this document reads in such a way as to suggest that not all British divisions issued Intelligence Summaries (at least as late as March 1916). For example: “If Divisional Summaries are issued, they also will be treated as confidential documents...” And later: “The same principles will apply to Divisional Summaries if issued;” In Vol. 16, Folder: Western Front, Orders and Instructions, 1914-1915. 2nd Army to Corps, September 29, 1915, further evidence is presented. The letter reads in part: “The issue [of Intelligence Summaries] by the Corps appears to be preferable to the issue of one by each Division.”

strategic and operational intelligence applications than for its ability to collect tactical details -- although tactical work was not neglected. From the retreat from Mons through the Race to the Sea, for instance, the RFC kept the British high command informed on a day to day basis of the location of the German armies, no small feat considering the puny size of the RFC at that time.²⁹ Tactical reconnaissance came into its own once the lines stabilized, as aerial observers helped locate enemy infantry and battery positions lying beyond ground observer line of sight. The RFC, however, was not a panacea for the BEF's intelligence needs, as it was constrained by the vagaries of weather, hours of daylight and the number of available aircraft. As most activity, including troop movement and trench repair, occurred at night or in overcast conditions, much valuable information escaped even the best aerial observers. Furthermore, the increased use of camouflage, and the fact that enemy gunners stopped firing when observation planes were overhead, added to the difficulties of artillery spotting. It was also practically impossible to tell from the air if trains located behind enemy lines were loading or unloading troops and supplies, and entirely impossible to tell if moving trains were full or empty. As early as March 1915, the British 1st Army counselled those under its command not to place their faith in aerial intelligence alone, but to develop ground level methods.³⁰ In 1917 and 1918, even with the great strides in aerial observation and photography, aerial reconnaissance did not supply all the details required on the

²⁹ S.F. Wise, *Canadian Airmen and the First World War, The Official History of the Royal Canadian Air Force, Vol. 1* (Toronto: University of Toronto Press, 1980), 334 - 344. Also J.F.C. Fuller, *A Military History of the Western World, Volume III, From The American Civil War to the End of World War II* (1957, New York: Da Capo Press, ?), 280. According to Fuller, in 1914 the RFC consisted of sixty-three planes, 165 officers, and 1,264 other ranks (a respectable number compared to other powers), but ended the war with 22,000 planes, of which 3,300 were front line aircraft, and 291,175 officers and men.

³⁰ NAC, M.G. 30 E61 (Mitchell Papers) Vol. 16, Folder: Western Front, Orders and Instructions, 1914 - 1915. Lieutenant General W.R. Robertson, Chief of the General Staff, GHQ to 1st Army, March 15, 1915.

enemy's position, and often only acted as confirmation for discoveries made by ground troops.³¹ Nevertheless, aerial reconnaissance was a powerful tool in the intelligence arsenal, one that became more potent as the war progressed. Indeed, intelligence collection, especially for counter battery purposes, would have suffered a severe setback had aircraft not been available. For example, Lieutenant Colonel Andrew McNaughton, the Canadian Corps' first counter battery staff officer, estimated that "under Position War conditions fully 30 per cent of the counter-battery information is supplied by the [air service] and in more mobile operations this proportion is much increased."³² One postwar assessment produced by the Counter Battery Office went so far as to say that "during open warfare...[air coverage]... is very often the only reliable source of [counter battery] information, and the effective neutralizing of hostile artillery fire at critical moments may depend almost entirely upon the work of the Corps Squadron."³³

Despite such praise, it remained very difficult for aerial observers to discern objects on the ground, as physical features appear quite different when viewed from above and when camouflaged. Depending on the height of the observer, some features were not visible at all. Table 3.1, "Visibility and Altitudes," reveals something of the limited vision affecting aerial observers. Remember too that in 1915 pilots, in addition to flying the plane, were trying to observe or photograph the ground, and were doing so while moving at fairly rapid speeds and sometimes

³¹ NAC, R.G. 9 III C2, Vol. 3988, Folder 3, File 12. Lecture by an observer with the Canadian Light Horse entitled "Observation and Intelligence," post Vimy, 1917 or 1918.

³² Major-General A.G.L. McNaughton, "The Development of Artillery in the Great War," *Canadian Defence Quarterly* (January 1929): 164. See also his "Counter Battery Work," *Canadian Defence Quarterly* 3.4 (July 1926): 380 - 391.

³³ NAC, R.G. 24, Vol. 1832, Folder GAQ. 8-15e. "Organization and Procedure of Counter Battery Office Canadian Corps Artillery," January 25, 1919. A corps squadron was an RFC (later RAF) squadron attached to an army corps for close reconnaissance work, artillery spotting, and aerial photography (after March 1916).

Table 3.1: Visibility and Altitudes³⁴

Altitude	Phenomenon Visible to Aerial Observers in Good Light
From 3,000 Feet	<ul style="list-style-type: none"> -- An attack could be followed. -- Bombing could be seen. -- State of trenches could be reported on (i.e. condition after bombardment). -- Some trench mortar emplacements visible. -- Tracks visible.
From 2,500 Feet	<ul style="list-style-type: none"> -- Men massed in trenches visible. -- Could sometimes determine if trenches were revetted or not.
From 2,000 Feet	<ul style="list-style-type: none"> -- Wire entanglements could be seen, but not their condition. -- Sandbagging and overhead traverses visible. -- Comparative width of trenches discernible.
From 1,500 Feet	<ul style="list-style-type: none"> -- Dugout entrances, comparative depth of trenches and men signalling aircraft (i.e. waving their helmets) were visible.
From 1,000 Feet or Less	<ul style="list-style-type: none"> -- Friendly troops could be distinguished from those of the enemy.

³⁴ NAC, M.G. 30 E100 (Currie Papers) Vol. 48. "Instructions for the Training of Divisions for Offensive Action," (S.S. 135), Table II, December 1916. Issued by GHQ. Machine gun posts and trench mortar positions were always difficult to see in photographs, especially as the war progressed and a more open defence was employed.

under fire.³⁵ Their view of the ground was brief, and often blocked by the plane's wings. Aerial observation on behalf of the artillery had additional drawbacks. Once an enemy battery was located, there were few means of communicating the findings to the gunners without the aircraft having to land first. Wireless communication was new and cumbersome, with the equipment taking up so much room that there was no space for an observer. The message bag system, whereby pilots dropped messages at designated drop zones, was available, as was the clock code system used to inform the artillery of needed shelling corrections, but on the whole, air to ground communication throughout the first half of the war was primitive and underdeveloped.³⁶ During the second half of the war, after wireless and other signal systems had improved, the value of the airplane as an intelligence gathering tool dramatically increased.

All armies employed balloons for gathering intelligence, but balloons suffered from the shortcomings outlined for other aircraft. Balloons had the added disadvantage of being stationary, making them tempting targets for enemy planes. Captain James Belton's and Lieutenant E.G. Odell's 1918 publication, *Hunting the Hun* clearly illustrates this drawback:

A few bombs were dropped [by the German pilot onto the Allied balloon] and the balloon took fire...The observation officer in the meantime had jumped out of the basket. He began to fall through space until his parachute opened. Then we witnessed a thrilling race as the burning balloon and the officer in his parachute began to descend to the ground, pursued by the Hun aviator who was using his machine gun on the unfortunate observation officer. Luckily the observation officer got safely to the ground.³⁷

³⁵ NAC, R.G. 9 III C4, Vol. 4310, Folder 1, File 1. "Hints. From the Point of View of an Airman, on Artillery Positions," 2nd Army, November 4, 1915; R.G. 9 III C3, Vol. 4187, Folder 2, File 3. "Notes on Course of R.F.C. School of Instruction for Other Arms." Also see S.F. Wise, *Canadian Airmen*, 343, 346.

³⁶ Bill Rawling, *Surviving Trench Warfare. Technology and the Canadian Corps, 1914-1918* (Toronto: University of Toronto Press, 1992), 27.

³⁷ James Belton and E.G. Odell, *Hunting the Hun*. (New York: Appleton & Company, 1918), 161-162.

In 1917, McNaughton was himself caught in a balloon that was the target of an enemy gun. For an entire evening German artillery tried to knock the balloon out of the sky, while McNaughton and his companion, protected by nothing but a wicker basket, rode out the storm.³⁸ The immobility of balloons also restricted their ability to keep pace with the advance during the more mobile phase of the war, in 1918, reducing their utility even further.

Aerial photography, in its infancy in 1915, was not an antidote to the ills plaguing aerial observers. Cameras capable of taking clear pictures from a moving plane were largely unknown, only beginning to be used in about February 1915. At that time, Brigadier-General John Charteris, the chief intelligence officer for the British 1st Army, gave his lukewarm endorsement to aerial photography, and slighted the work of aerial observers in the process:

We have just started this method of reconnaissance [aerial photography], which will I think develop into something very important. At present it is a very necessary check on the exaggerated reports and the imagination of air observers. Photographs cannot lie -- most air observers do, probably unconsciously, though I am not so sure that it is all unconscious.³⁹

At the Battle of Loos, in September 1915, many photographs were blurred and of poor quality. Even at the Somme, a year later, photographs were still not fully reliable.⁴⁰ This did not stop the British from intensely photographing specific sections of line for planning and mapping purposes, as was done for the area

³⁸ The harrowing story is retold in John Swettenham's *McNaughton, Vol. 1, 1887-1939* (Toronto: The Ryerson Press, 1968), 103-106. Besides airplanes, corps squadrons had two Kite Balloon Sections each with one balloon.

³⁹ John Charteris, *At G.H.Q.* (London: Cassell and Company, Ltd., 1931), 77.

⁴⁰ Robin Prior and Trevor Wilson, *Command on the Western Front: The Military Career of Sir Henry Rawlinson, 1914-1918* (Oxford: Blackwell Publishers, 1992), 110, 163.

around Neuve Chapelle in the days leading up to the British assault in March 1915. By October 1915, when photographs had become much more plentiful and reliable, the French Army was urging they be studied “in the most detailed manner possible, with the object of giving the Staff all the necessary information for it to draw up its operation orders and of giving the troops all the information which will facilitate their rapid arrival at their objective with the smallest possible loss.”⁴¹ Moreover, photographs provided an historical record of given areas that allowed a comparative analysis be made from one day or week to the next; anything out of the ordinary was soon discovered. But even with the great strides in aerial photography, the 1st Canadian Division could write in January 1918 that

The disposition of the enemy forces is ascertained largely from the examination of prisoners, [while] the enemy defences can only be accurately known by constant and careful [ground] observation. Aeroplane photographs provide considerable information but are necessarily confirmatory [sic] only of the Intelligence Reports [of others].⁴²

Furthermore, the skills essential for interpreting photographs took time to develop and disseminate throughout the army. As a result, early photographs generally revealed little tactical information beyond the location of the two sides trench systems.⁴³ It was also important that “the ground covered by the photograph be reasonably well known” beforehand, for maximum advantage to be gained from

⁴¹ NAC, M.G. 30 E61 (Mitchell Papers) Vol. 16, Folder: Western Front, Orders and Instructions, 1914 - 1915. “Notes Regarding the Interpretation of Aeroplane Photographs,” translated from the French, October 20, 1915.

⁴² NAC, R.G. 9 III C3, Vol. 4025, Folder 7, File 5. 1st Division to 1st Brigade, January 10, 1918.

⁴³ James Edmonds, preface to *Military Operations, France and Belgium, 1915*, (London: His Majesty’s Stationary Office, 1927), Vol. 1, vii; Michael Occleshaw, *Armour Against Fate. British Military Intelligence in the First World War* (London: Columbus Books, 1989), 60-65.

photographs (proving again that aerial intelligence was not an intelligence elixir).⁴⁴ Moreover, in 1915 there were still too few aerial photographs available for a wide distribution. There were exceptions, of course, but divisions were about as far down the chain of command that photographs reached in any regular way. Battalions, and even brigades, seldom received aerial photographs, as Captain Macintyre, scout officer for the 28th Battalion attests. In November 1915, without photographs of the front, he had "to map all our trenches and all the features of No Man's Land by surveying it piece by piece with the Scouts at night with a luminous compass and pacing or crawling the distances."⁴⁵ In April 1916, after a year in the trenches, Canadians still complained that aerial photographs were an intelligence source rarely seen at brigade and battalion headquarters, let alone at company and platoon levels of command.⁴⁶ Nevertheless, during the second half of the war, photographs became a powerful intelligence tool, and when the fighting ended in November 1918, over half a million photographs had been taken by the Royal Flying Corps (the Royal Air Force from April 1, 1918) for intelligence purposes.⁴⁷

The problems plaguing the early development of aerial reconnaissance and photography were not of immediate concern to the 1st Canadian Division. Until September 1915, the Canadians, apart from their artillery, had little direct contact with the Royal Flying Corps. It was rare for a division to have a squadron attached to it, except on a temporary basis for special assignments. Until early 1916, the

⁴⁴ NAC, R.G. 9 III C3, Vol. 4088, Folder 16, File 2. Lecture Outline on "Notes Regarding the Interpretation of Aeroplane Photographs," July 1916.

⁴⁵ NAC, M.G. 30 E241 (Macintyre Papers) Vol. 1. Diary entry November 11, 1915.

⁴⁶ NAC, R.G. 9 III C3, Vol. 4140, Folder 10, File 2. 2nd Division to 6th Brigade, February 20, 1916; Vol. 4131, Folder 9, File 5. 6th Brigade's staff captain(I) to units, April 11, 1916; M.G. 30 E148 (Agar Adamson Papers) Vol. 3, Folder: War Letters -- January 1916. Adamson, who was serving in the PPCLI, seems to be describing to his wife in a letter dated January 25, 1916, his first glimpse of an aerial photograph.

⁴⁷ Occleshaw, *Armour Against Fate*, 60-65.

normal procedure was for armies, rather than smaller formations, to order close reconnaissance of the enemy line, as armies had a larger perspective of the front, could better coordinate limited aerial resources, and could thus maximize the use of aerial surveillance as an intelligence tool. Corps and divisions could, however, make special requests for photographs of specific areas.⁴⁸

However valuable early aerial surveillance may have been, ground level reconnaissance continued to play a prominent role in the acquisition of tactical combat intelligence. Some believed that the infantry supplied the bulk of all intelligence gathered, and that actual contact on the ground was the "surest method of identifying the enemy."⁴⁹ Personal reconnaissances by officers were a valuable method of intelligence gathering. Because commanding officers could not see for themselves the entire front their commands occupied, staff and other officers, including intelligence officers, regularly went forward to collect information and view events on the commander's behalf. The better officers, of course, took a natural interest in studying the enemy to learn something of their weaknesses, habits and threats. Reconnoitring the front lines provided these officers with an understanding of conditions not always clear in situation reports, but it was risky work. Lieutenant Colonel W.F.R. Hart-McHarg, the commander of the 7th Battalion, was killed at Second Ypres (April 1915) while on one such reconnaissance, as was Major-General M.S. Mercer, commander of the 3rd Canadian Division, at Mount Sorrel in June 1916.

⁴⁸ NAC, M.G. 30 E61 (Mitchell Papers) Vol. 14, File Folder 92. "Systems of Carrying Out Air Reconnaissance," issued by GHQ, April 1915; Also Vol. 16, Folder: Western Front, Orders and Instructions, 1914 - 1915. "Notes on Intelligence Duties -- Second Army," August 1915.

⁴⁹ Tuohy, *The Secret Corps*, 235. NAC, M.G. 30 E117 (Parsons Papers) Vol. 4, Folder 23. "Lecture by Major J.L.R. Parsons. General Staff, 2nd. Canadian Division," August 7, 1917.

Infantry patrols, employed throughout the war, were another indispensable method for gathering intelligence. As one British brigade's Trench Standing Orders pointed out:

The best security against attack is active patrolling and constant observation of the enemy's line, so that he cannot undertake any new work without steps being taken to prevent its advance. The enemy's wire will be constantly patrolled to ensure that he has cut no gaps in it with a view to launching an attack. Patrols will also frequently visit our wire to ensure that it is efficient.⁵⁰

The 2nd Army wrote that "superiority in patrolling must be established [over the Germans] before any minor operation can be attempted." The same could be said of major operations.⁵¹ Dominating the ground made intelligence gathering easier, as patrolmen worked the ground until they were thoroughly familiar with the terrain.⁵² Patrols also helped "clear up situations about which some doubt exists."⁵³ During the earlier battles of the war, patrols were sometimes the only means available to commanders for keeping pace with unfolding events.

Patrol work, normally carried out at night, was an arduous task, with danger at every step. Many soldiers were killed or wounded after unexpectedly walking into an enemy patrol or ambush.⁵⁴ The terror of being caught in a German searchlight or flare was ever present, as Captain G.B. McKean of the 14th Battalion remembered: "As the light broke and fell I felt myself to be assuming gigantic

⁵⁰ NAC, M.G. 30 E54 (Phelan Papers) Folder 3. Trench Standing Orders, November 1915.

⁵¹ NAC, R.G. 9 III C3, Vol. 4116, Folder 4, File 9. "Lessons Drawn from the Various Minor Operations carried out by the 2nd Army up to the 9th February 1916."

⁵² NAC, R.G. 9 III C3, Vol. 4095, Folder 36, File 3. "Employment of Scouts and Snipers in Trench Warfare," 1916; M.G. 30 E50 (Jones Papers) Folder 3: Lectures: Canadian Corps Officers' School, 1916. "A Suggested Programme For Training Scouts."

⁵³ NAC, R.G. 9 III D3, Vol. 4870. 2nd Brigade War Diary, April 16, 1915.

⁵⁴ NAC, R.G. 9 III C3, Vol. 4063, Folder 13, File 3. Reports by Scout Anderson and Sergeant F.H. Honey describing a patrol on the night of November 27, 1917, on which the officer leading the patrol was killed, is an example.

proportions; I felt as if the eyes of the whole German Army were being riveted upon me and a thousand rifles were levelled at me!"⁵⁵ It took men with steeled nerves to do patrol work well. One officer remembered the darkness: "It was so dark that I stepped on one of our sentries lying in a Listening Post. He could not tell who I was and cursed me for a clumsy fool and remarked that I would probably walk right into the German lines."⁵⁶

The jitters affected everyone on patrol, enemy troops included. During one Canadian patrol, a scout crawling near the German lines caught his foot in some wire, which then rattled. The Germans, thinking a raid was in progress, opened with machine gun and artillery fire. The Canadian patrol made a hasty retreat but the German shelling distressed the Canadian trench garrison who thought the returning Canadians were a German raiding party. Canadian shells began to rain down on the unfortunate patrol now caught between two angry armies. Taking refuge in a shell-hole the patrol waited out the exchange. The whole line was ablaze "because a scout caught his foot in some wire!"⁵⁷

Patrols, gathering information of an incremental nature, rarely discovered major secrets about German defences. Everything observed, heard, and encountered while on patrol had to be reported in order for battalion and other commanders to build up a pool of knowledge on a given sector. Patrols also helped pin-point for destruction individual German machine-gun nests, trench mortars, listening posts, dugouts, sniper posts, observation posts, strong points, command stations, and many other tactical features. They also secured information by recovering German shell fragments, equipment, maps and documents from no

⁵⁵ G.B. McKean, *Scouting Thrills* (New York: The Macmillan Company, 1919), 20.

⁵⁶ NAC, M.G. 30 E241 (Macintyre Papers) Vol. 1. Diary-memoir entry November 1, 1915.

⁵⁷ McKean, *Scouting Thrills*, 69-70.

man's land, and by capturing prisoners of war. From these sources intelligence officers identified German units and passed this information on to higher authorities so that GHQ could follow the German order of battle. Company and battalion commanders noted tactical information of use to themselves in notebooks and on maps, and then passed it on to brigades and divisions for their consumption.

Patrol work was a difficult task, and one that took time to develop. Until the summer of 1915, patrol work in the 1st Canadian Division was unsystematically carried out. The problem was that company commanders were responsible for organizing their own patrols. They did this as best they could, but throughout much of 1915, company commanders bore the principal burden for gathering intelligence along the front, even though they were weighed down with other pressing concerns. Oftentimes they neglected patrolling, observation, and listening post duties while trench repairs and other work was carried out. Coordinating intelligence gathering missions with neighbouring commands proved equally difficult, as neighbouring company officers were similarly pressed for time. Companies without highly motivated and well organized officers were bound to suffer an information gap. In the end, patrol work was often an ad hoc endeavour, and one that did not achieve maximum results. One officer thought it was only about July 1915, "while the Canadian Division was in this part of the line [Ploegsteert Wood] that they [battalions] commenced to systematically patrol NO Mans Land [sic] putting down on to large scale maps all the information" collected.⁵⁸ Towards the end of 1915, once divisions instructed their battalions to organize intelligence sections, patrol work improved even more, for then there was an organization of scouts dedicated to patrolling and observation work available to battalions.⁵⁹

⁵⁸ NAC, M.G. 30 E236 (Villiers Papers) Vol. 4, Folder 7. Diary, July 1915.

⁵⁹ See Chapter Five, page 126 for a discussion on the development of battalion intelligence sections.

During daylight hours patrolling no man's land largely ceased and ground observers took over. Company commanders were responsible for posting trench observers, but had little time to give their full attention to the task. The result was often a disorganized, amateurish and unsystematic arrangement for observing the enemy's lines.⁶⁰ By October 1915, the British 2nd Army, to which the Canadians were then attached, made reference to the infantry's poor observation work, and complained that front line observers collected too little information. The 2nd Army attributed this "to the small number of trained observers who are available and to the fact that the necessity for continuous observation of the whole of the enemy's front lines is not always realized." The 2nd Army further stated that:

It has perhaps not been sufficiently recognized that the reconnaissance work of scouts and patrols, which plays so important a part in active operations must during stationary warfare be largely supplemented by a system of continuous observation from fixed stations. If the battalion scouts are trained as intelligence observers as well as for the patrol work they already carry out in front of the trenches, it will be possible to obtain useful information by this means. Scouts will have to be trained, for instance, to recognize the various kinds of equipment and uniforms worn by the enemy, and to report their observations intelligently. For this purpose they will have to be provided with the necessary glasses, telescopes and periscopes.⁶¹

The 2nd Army called for a "chain of permanent observation stations" carefully situated to give maximum coverage of the German position from well concealed vantage points. It recommended there be at least two posts per battalion frontage, although the ideal number depended on the nature of the ground being held. Regardless of the number of posts, they were not to interfere with artillery OPs,

⁶⁰ NAC, M.G. 30 E6, (Mitchell Papers) Vol. 16, Folder: Western Front, Orders and Instructions, 1914 - 1915. 1st Division to 1st Brigade, March 8, 1915. Also letter from the 2nd British Corps to Divisions, July 16, 1915; R.G. 9 III C3, 4131 Folder 11, File 1. Macintyre, staff captain(I), 6th Brigade, to units, April 23, 1916.

⁶¹ NAC, M.G. 30 E61 (Mitchell Papers) Vol. 14, Folder 92. Amendments to the October 1915 "Instructions Regarding Intelligence Duties, 2nd Army."

and were in fact independent of them. The 2nd Army also advised that OP locations be plotted on maps that clearly showed what terrain they overlooked, and what ground was out of sight. Aircraft were then used to observe such dead ground. By early 1916, the Canadians had adopted these suggestions, and from then on infantry observation posts were a regular feature of the Canadian intelligence effort.⁶²

To be most effective, observation posts had to be well concealed, constructed and equipped. The need for concealment is obvious, as a located OP was a destroyed OP. By the end of the war permanent observation posts, if not built in haste, were usually spacious enough for at least two observers and their equipment, plus room for the additional influx of officers that normally occurred during active operations. OPs were, as a rule, carefully situated to achieve the widest and deepest view of the German lines possible, but there was no fixed establishment in either personnel or equipment. Certain staples were always supposed to be on hand: maps, field glasses, a telescope with director board for taking rapid and accurate bearings, a telephone, compasses, photographs and mosaics of the area under view (at least from 1916 onwards), and a luminous watch for night work. Often observers and others complained that the needed equipment was unavailable, and shortages continued throughout the war.⁶³

Snipers also made observations. Snipers, working the same ground day after day, worked in pairs, one man observing, one man firing. At first the British and Canadians did not recognize these sniper - observer teams for their intelligence gathering potential. This was likely due to the fact that early in the war, certainly when the Canadians first arrived, sniping did not exist in any organized fashion.⁶⁴

⁶² Ibid.

⁶³ Currie, "Historical Resume," xxii.

⁶⁴ H. Hesketh-Prichard, *Sniping in France. How the British Army Won the Sniping War in the Trenches* (Reprint, USA: Lancer Militaria, 1993), 13-14.

But as sniping matured and became a regular feature of trench warfare, the importance of sniper teams to intelligence became obvious. They watched the front lines carefully for any sign of German movement, and became intimately familiar with the enemy position. Since the sniper - observer teams were often amongst the first to notice any changes or alterations made to enemy trenches, see reliefs taking place, and detect changes in enemy habits, they made ideal intelligence gatherers.

Once the lines stabilized towards the end of 1914, men in listening posts (LPs) were employed to gather intelligence. Listening post work was a regular feature of trench routine by the time the 1st Canadian Division arrived in France in February 1915, but its importance declined over the years as mechanical listening sets came into use.⁶⁵ All 'other ranks' took their turn in an LP. Typically, LPs contained teams of two or three infantrymen who laid out in no man's land, often beyond friendly wire, in a ditch, shell-hole, or behind a stump or some other form of cover. Major Agar Adamson of the Princess Patricia's Canadian Light Infantry (PPCLI) recorded in March 1915 that:

[Men on LP duty] often just lie out in the open and take the chance of not being spotted when [German] flares go up. Sometimes they dig a hole in the ground the size of a man lying down and cover it over with muddy sacking. If properly done and the man remains quiet they are hard to detect unless a flare drops right upon them and continues to flare, as they often do.⁶⁶

Since the work was so exacting, men on LP duty worked in one or two hour shifts.⁶⁷ They listened to enemy activity and reported on the sounds emanating

⁶⁵ Occleshaw, *Armour Against Fate*, 118. Wireless traffic analysis, for instance, revealed a great deal about the enemy order of battle and troop dispositions -- information not readily secured through other means. See John Ferris, "The British Army and Signals Intelligence in the Field During the First World War," *Intelligence and National Security* 3.3 (October 1988): 23 - 48, for greater detail.

⁶⁶ Agar Adamson, *Letters of Agar Adamson*, ed. N.M. Christie (Nepean, Ontario: CEF Books, 1997), 38. From a letter dated March 10, 1915.

⁶⁷ Belton and Odell, *Hunting the Hun*, 133.

from the German trenches, such as moving transport, railways, banging and hammering. German-speaking soldiers also listened to conversations and to the various accents spoken by German troops to try and determine the unit's ethnic mix. This last point was sometimes revealing of a unit's fighting spirit. In addition, LPs acted as an early warning system in much the same way as prewar picket posts. Soldiers in listening posts were often the first men to see and feel a German assault or foray, and were expected to sound the alarm.⁶⁸ Company commanders were responsible for establishing listening posts along the company front, in addition to the myriad other duties they performed.

Listening post work was another frightening and "very risky" activity. Captain McKean remembered listening post detail as being "the most detestable" job "of all the unpopular duties that fell to the lot of the suffering Tommy." "It was a dirty, dangerous job, and thoroughly disliked. The miseries of it on a cold wet night can easily be imagined." He noted that "Sometimes a little wire was strung out in front as protection against attack, but more often the post was unprotected."⁶⁹ Many LPs simply disappeared along with the men in them, victims of bombardments or stealthy German patrols.⁷⁰ In the early morning hours (5 a.m.) of December 23, 1915, for example, two men from the 14th Battalion went out on listening post detail. Fifteen minutes later they signalled 'All Correct' by pulling once on the tug line that connected them to the sentry on duty in the trench. "Immediately afterwards" three shots were fired. The sentry pulled on the wire but got no answer. Two men went out to investigate and found one man dead, and no

⁶⁸ NAC, M.G. 30 E149 (Adamson Papers) Vol. 2, Folder: War Letters -- March 1915. Adamson to Mabel, March 10, 1915, offers an example.

⁶⁹ McKean, *Scouting Thrills*, 18-19.

⁷⁰ Rawling, *Surviving Trench Warfare*, 50.

trace of the other.⁷¹

LPs were a very imperfect source of intelligence, especially where enemy mining activity was concerned. Fear of being blown sky high from below caused imaginations to run wild. Nothing could be more lonely than lying in the mud in the dead of night between the opposing lines. Not surprisingly, many false mining reports were made. If headquarters suspected enemy mining, however, they detailed special LPs, patrols and sentries in an effort to confirm or refute the claim. Upon investigation by intelligence and tunneling officers most mining noises were explained away as normal trench activity such as German riveting, sentries stamping their feet, rats scurrying about, frogs croaking, running water, wind flapping waterproof sheeting, flies buzzing at the bottom of a hole, or the wind whistling over empty tins and jars discarded into no man's land. On occasion a man's own heavy breathing or the beat of his heart were mistaken for the sounds of enemy mining. Very occasionally mining was actually discovered, although sometimes it was friendly.⁷² No doubt the tug-line that connected the LP to the trenches offered some reassurance to those lying out in no man's land, but feelings of isolation must have persisted.⁷³

Intelligence and other officers also tapped sentries for information, but not

⁷¹ NAC, R.G. 9 III C1, Vol. 3866, Folder 102, File 1. 3rd Brigade to 1st Division, December 23, 1915. The only connection between men on LP duty and other friendly forces was a tug wire that reached back some 50 to 125 yards to the sentries on duty in the trenches. Every few minutes the men in the listening post pulled once on the cord to let the sentry know that they were okay. Two pulls had a different meaning, such as 'German relief taking place;' three pulls might mean 'We've seen something in front and are hanging on;' while four tugs on the cord might mean 'We're coming in.' See M.G. 30 E 60 (Matthews Papers) Vol. 6, Folder 20.

⁷² NAC, M.G. 30 E300 (Odlum's Papers) Vol. 24, Folder: Trench Devices -- Offensive, 1915 - 1916. 2nd Army to Canadian Corps, May 20, 1916; McKean, *Scouting Thrills*, 46; Ferdinand Tuohy, *The Battle of Brains* (London: William Heinemann Ltd., 1930), 171.

⁷³ See also M.G. 30 E 300 (Odlum Papers) Vol. 24, Folder: Raids, February 1916 - June 1917. "Listening Posts and Patrols," n.d.

normally for tactical details on the enemy's defences. The sentries' job was to watch for enemy surprise assaults, raids and other threatening moves, and sound the alarm. Gathering other forms of intelligence was a distraction to these very important tasks. Besides sentries, since they had no special training in observation and reporting, often submitted vague and inaccurate reports.⁷⁴ Additionally, sentries did not necessarily work the same section of trench day after day; nor were the same individuals inevitably used from one day to the next. For best results, observers had to view the same section of enemy line for days and weeks on end to become intimately familiar with all its subtleties. Constant rotation meant sentries were never fully familiar with the German lines. Moreover, sentry work was sometimes only half-heartedly carried out, and not taken seriously. In September 1917, for example, the 1st Brigade found some sentries ill-trained in their basic duties, and lacking periscopes. The brigade discovered, upon further investigation, that they had been "instructed not to show themselves over the parapet with the result that they were useless for their job."⁷⁵ The next year, in February 1918, the 1st Division felt the need to remind all units that "The safety of the whole Divisional Front lies in [the sentries'] hands," and that too often the day-time sentries lingered "about in the Support and Reserve Lines" reading books, "etc. etc." The divisional commander called for "extreme vigilance," and expected his officers to take a more "serious view of their responsibilities regarding Sentries."⁷⁶ Proper instruction,

⁷⁴ NAC, R.G. 9 III C3, Vol. 4187, Folder 2, File 3. "Lecture on Intelligence. For Regimental Officers and non-Commissioned Officers." In Belton and Odell, *Hunting the Hun*, 135-138, we are told that sentries had well protected look-out posts, and were supplied with periscopes whenever possible. Fraser, *Private Fraser*, 34. See October 1, 1915 entry.

⁷⁵ NAC, M.G. 30 E15 (Griesbach Papers) Vol. 3, File 16(A). 1st Brigade to battalions, September 6, 1917.

⁷⁶ NAC, R.G. 24, Vol. 1883, Folder 5, File 8. 1st Division to subordinates, February 19, 1918. In July 1917, the 1st Brigade had similar concerns after the Germans, in broad daylight, "carried off one of our men." The commander noted that in the future any similar occurrence would be investigated, and if neglect was found the person responsible would be punished as an example to others. See R.G.

though, did not necessarily eliminate false alarms. Captain Macintyre noted that “It is strange how an alarm will spread down the line at night. Some sentry sees a line of fence posts in No Mans’ Land -- after a while they appear to move in the mist so he fires and shouts the alarm. The firing spreads and soon extends over a mile of the front.”⁷⁷

Other non-intelligence personnel supplied information as well. Every man in the line, and every officer who peered through a periscope or over a trench wall, was a potential source of information. If soldiers in a given trench garrison heard or saw something out of the ordinary, officers checked their stories. After all, any information, regardless of its source, might prove valuable. In an effort to improve the quality of intelligence gathered by ordinary infantry, GHQ, in March 1915, issued a pocket card (S.S.381) on the “Collection of Information Regarding the Enemy,” and reissued it in October 1915. This card, which each officer received, outlined methods for identifying enemy units, and offered other intelligence tips, such as the location of hidden pockets in German tunics, and the location of regimental numbers on various pieces of equipment and clothing, all of which GHQ used to build the German order of battle.⁷⁸

Ideally, patrols, observers, sniper teams, listening post men, sentries, and others worked in unison, confirming and verifying reports, and guarding against surprise. This, no doubt, gave the men in the trenches some degree of comfort;

9 III C4, Vol. 4332, Folder 3, File 25, 1st Brigade to subordinate commands, July 18, 1917.

⁷⁷ NAC, M.G. 30 E241 (Macintyre Papers) Vol. 1. Diary entry September 29, 1915. Another example can be found in McKean, *Scouting Thrills*, 13-14.

⁷⁸ NAC, M.G. 30 E61 (Mitchell Papers) Vol. 14, Folder 92. “Instructions Regarding Intelligence Duties, 2nd Army,” October 1915. R.G. 24, Vol. 22,000. Pocket Card, S.S. 381; R.G. 24, Vol. 1861, Folder 64. W3092 Pocket Card. The War Office also issued “Instructions on the Collection and Transmission of Intelligence by Troops” in September 1915, which said much the same thing, R.G. 24, Vol. 22011.

knowing that a watch was kept, they could catch some much needed rest.⁷⁹ Figure 3.2, “Battalion Intelligence Gathering and Security Screens as Practiced by the 7th Battalion, March 1916,” illustrates how this interconnectedness was to operate in practice. As shown in the figure, patrols (marked as D1 and D2) occupied the forward-most positions. These parties traversed no man’s land on fact-finding missions, and acted as security screens for friendly trench garrisons and work parties. Operating just behind the patrols, but usually outside friendly wire, were the listening posts (represented as A1 - A4). Like patrols, listening post work was normally conducted at night. Further back were trench observers and sentries who kept watch during the day and night. It was imperative that these front line information gatherers be vigilant to avoid tragedy. An inquiry into a successful German raid against the 54th Battalion during the night of January 1, 1918, concluded that “Listening posts were not well placed with reference to ground, and were far too close in,” and that “Moving patrols did not go out early enough.” Moreover, the NCO at the threatened sector told the sentries to get under cover when the German bombardment commenced, leaving nobody to watch the enemy. Leadership was obviously lacking. The report, while elaborating on these and other lessons, made it clear that the various elements in the front line intelligence gathering system were interrelated.

Information was also supplied by commands relieved in the line. When a relief was conducted properly incoming commands learned a great deal of helpful information from the outgoing troops concerning conditions along the front. About twenty-four hours before the main body of troops entered the trenches, officers from the relieving force met with officers from the out-going command to arrange the relief, look things over first hand, receive up-to-date maps and photographs if

⁷⁹ NAC, M.G. 30 E149 (Adamson Papers) Vol. 2, Folder: War Letters -- March 1915. Adamson to Mabel, March 10, 1915.

**Figure 3.2: Battalion Intelligence Gathering and Security Screen
as Practiced by the 7th Battalion, March 1916⁸⁰**

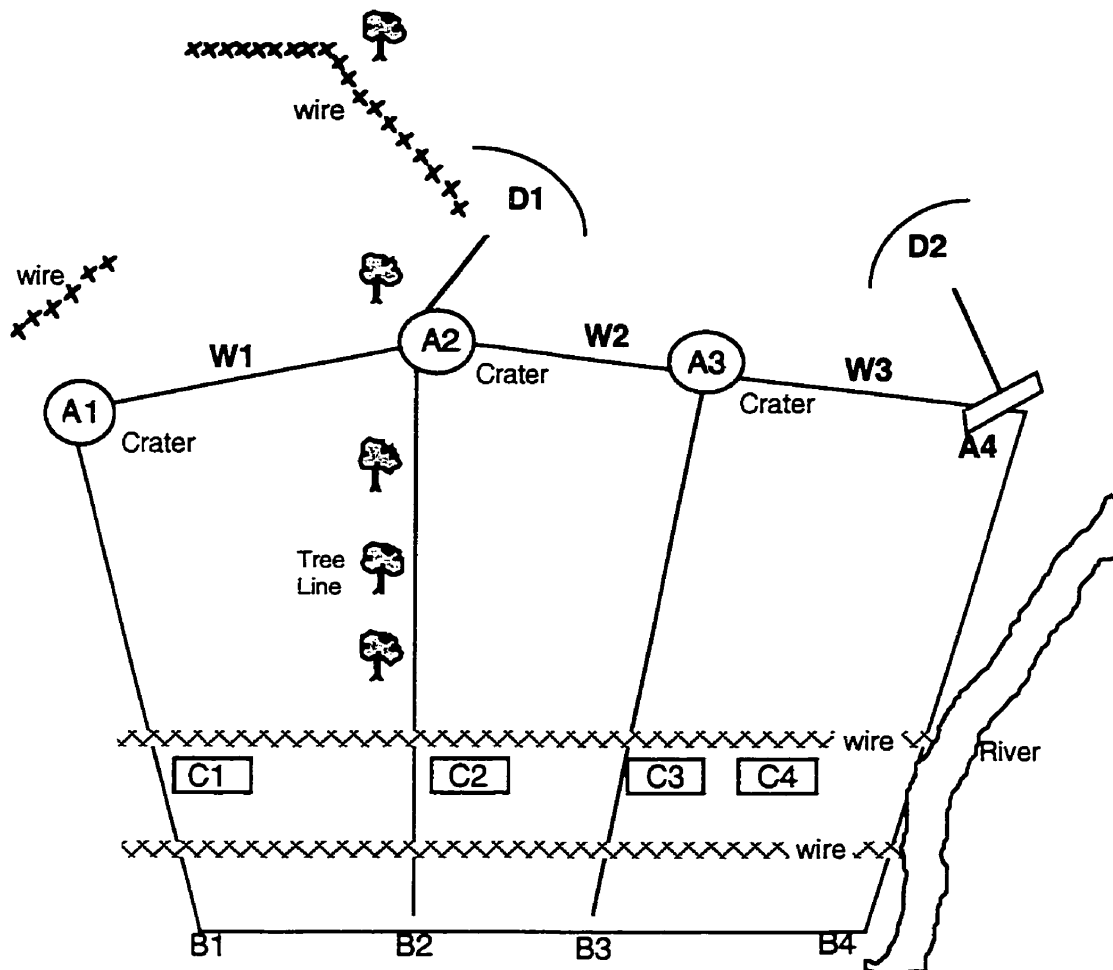

Legend:

- A1 - 4. LP Line. Nine men per post on three man shifts, and placed in or behind obstacles (shell holes, ditches, walls). Distance out: 75 - 125 yards.
- B1 - 4. Trench sentries, each with a relief that sleeps by him, connected to LP by cord or telephone wire. Wire connected to alarm to attract sentry's attention.
- C1 - 4. Trenches or ditches used in extreme light or in local conditions where posts further forward are inadvisable. Also used by support groups or on nights that extra observers are required.
- W1 - 3. Lateral tug wires.
- D1 - 2. Patrols. Only one goes out at a time. All posts informed. All advanced patrolling performed by regular scouts.
- B1 - A1; B2 - A2; B3 - A3; B4 - A4. Tug lines from LPs to sentries.

⁸⁰ Based on Lt. Colonel Odlum's diagram in NAC, M.G. 30 E300 (Odlum Papers) Vol. 24, Folder: Trench Discipline - March 1916 - April 1918. 7th Battalion to 2nd Brigade, March 8, 1916.

available, and any other information of value. This other information included:

All information of value such as the name of the opposing force, whether they are Prussian, Saxon or Bavarians, the whereabouts of their machine guns and if there was much activity shown on the part of the enemy, [and a] description of their S.O.S. signal, if known, is passed on to the relieving force.⁸¹

Incoming officers also noted the number of men needed to hold the line, the availability of shelter accommodation, medical arrangements, the defensive work underway and proposed, the condition of wire entanglements and general defences, the enemy's habits and sniper activity, the location of the garrison's water supply, and any specific dangerous points. Incoming officers also had to learn what artillery support was on hand, the location and means of communications available, the lines of advance used in counter attacks, the number and location of listening posts, and other similar details.⁸² There was, in effect, a lot to absorb during the very brief period in which the hand-over took place, and compiling intelligence was only one of the many concerns of incoming officers. For example, during the relief of the French 11th Division prior to the Battle of Second Ypres, Major H.H. Matthews, a company commander in the 8th Battalion, along with other officers, entered the lines early in order "to get some idea of the line we should each have to hold later on, and also to enable us to arrange the details for the relief." Assuming the language barriers were minimal, these officers learned from their French counterparts the intricacies of that particular trench system. Not a great deal of time

⁸¹ Belton and Odell, *Hunting the Hun*, 132.

⁸² NAC, R.G. 9 III C3, Vol. 4098, Folder 42, File 1. "Notes Bearing on Battalions Relieving One Another in the Trenches," September 1915; Vol. 4056, Folder 32, File 6. "Canadian Corps Trench Standing Orders," July 1916 reprint of October 1915 order; R.G. 24, Vol. 22,015. "Notes From the Front, Part IV," May 1915, pages 8-9.

was available for doing this, however, for after marching in the officers ate and then caught a few hours sleep. "During the afternoon we examined the trench and position of the enemy as well as we could with glasses." This seems to have been the extent of their surveillance.⁸³

In the forward-most trenches the relieved force passed information to the incoming troops by word of mouth and by reference to any available maps of the German lines. The quality of maps, of course, might vary from one relief to the next and, indeed, even within the same relief. At Second Ypres, the commander of the 15th Battalion believed the French handed over excellent maps.⁸⁴ However Colonel W.W. Murray, in his book on the history of the 2nd Battalion, judged the maps handed over by the French to be of poor quality and scarce; some officers, he says, did without.⁸⁵ Headquarters further removed from the front learnt a great deal from written records and photographs kept by the relieved force, although conversations with out-going officers were no doubt valuable. Indeed, after the Battle of Festubert (May 1915), the 2nd Brigade wrote: "Officers of relieving units should be here [at the front] early so as to see [the] situation and have it explained to them before dark."⁸⁶

Sometimes relieving officers did not have the standard twenty-four hours to conduct the relief. On September 25, 1915, the 28th Battalion went to the front with one hours notice. The relieved battalion gave what information it could on the sector "which was not much, as they had only been in the line one day [themselves]. They also gave [the 28th Battalion] one soiled and partly torn map of

⁸³ NAC, R.G. 24, Vol. 1820, Folder 5-10. Report by Major H.H. Matthews.

⁸⁴ J.A. Currie, *"The Red Watch" With the First Canadian Division in Flanders* (Toronto: McClelland, Goodchild & Stewart, 1916), 204.

⁸⁵ Murray, *2nd Canadian Battalion*, 36.

⁸⁶ NAC, R.G. 24, Vol. 1883, Folder 5, File 8. "Narrative of Events Festubert Action 19th. to 26th. May, 1915," 2nd Canadian Infantry Brigade.

the area which had the German line marked on it but not ours. This was the only map they had.” The scout officer noted:

Our move had been so hurried that there had been no time to send the usual advance party up to look over the line. We hardly knew where the German trenches were nor how much distance lay between them and us, all we could hope for was a quiet night [so that] in the morning we could get our bearings.⁸⁷

It was difficult to fight a war with such a paucity of information. It took time for officers and men to familiarize and orient themselves when entering the lines, especially when entering an unfamiliar section of trench, and so the relief was a very important procedure.

If incoming officers met with uncooperative or uncoordinated commands, the flow of information on a given section of lines could be equally limited. In September 1915, the relief of the 35th British Brigade by the Canadians was one that did not yield much information. Captain Paul Villiers, of the 3rd Brigade, recorded

how very difficult it was to make arrangements [for the relief] as the [Brigadier of the 35th Brigade] would not give his Brigade Major any information. The consequence was that our Brigade Major was quite unable to make any arrangements, and all had to be delayed til [sic] their General could be got at.⁸⁸

Not all reliefs, then, were as informative as they might have been. If the relieved force forgot some important piece of information, the incoming troops had to learn about it all over again. The value of information gained in a relief all depended upon the diligence of those being relieved and the thoroughness of those going in.

⁸⁷ NAC, M.G. 30 E241 (Macintyre Papers) Vol. 1. Diary entry, September 25, 1915.

⁸⁸ NAC, M.G. 30 E236 (Villiers Papers) Vol. 4, Folder 7. Diary entry, September 26, 1915. This is also interesting commentary on the role of the staff captain(I) during a relief at this stage in the war -- he is not mentioned.

Slack units and formations might not have much to offer, as Major Adamson complained in March 1916: “none of the H.Q. officers [of the relieved battalion] could give us any information about the trenches, none of the trenches has any parapets or wire in front.”⁸⁹ The Canadians learned through bitter experience the value of a good relief. The disasters at Second Ypres in April 1915, Festubert in May, and St. Eloi in April 1916 can all be partly attributed to poor relief procedure.

Trench experience helped the Canadians hone the intelligence gathering skills taught them by the British. In 1915, the Canadians also learned how the various sources of trench intelligence were interconnected. This was an important lesson, for it was only after they had mastered the basic trench intelligence techniques that they began to use intelligence to their advantage. Although such procedures as patrol work, observation work, and sniping were at first unorganized, the Canadians did manage to generate and collect tactical details. However, there was room to improve. In the meantime, the divisional Intelligence Summary helped the Canadians organize and control the information that did come in, and provided commanders and staff with a base of knowledge on which to build plans. Moreover, Intelligence Summaries acted as an effective link between the various combat arms, and this made common goals more easily attainable. Intelligence and Intelligence Summaries, in other words, pulled the various parts of the corps together for the betterment of the whole. As most histories of the Canadian Corps acknowledge, this cohesion was one of the principal factors in the corps’ combat success.

⁸⁹ NAC, M.G. 30 E149 (Adamson Papers) Vol. 4, Folder: War letters, March 1916. Adamson to Mabel, March 5, 1916.

CHAPTER FOUR

INTELLIGENCE AWAKENING: 1915

On March 3, 1915, when the Canadians first occupied a portion of trench under their own responsibility, they had yet to realize the depth and incessant nature of intelligence work. It was only through experience in the field that these aspects were revealed, much as it was only by living the trench experience and conducting operations for themselves that they came to understand trench warfare. What they learned during their first year in the lines was that intelligence was indispensable to planning, and that battlefield failure often stemmed from ignorance. Important, too, was their discovery that the communication system, so vital for transmitting information, was very fragile in the combat zone, and when it broke down during active operations, as it regularly did, command and control was exceedingly difficult. Without news from the front, commanders further to the rear were left in the dark, and so could not effectively intervene and shape the fighting. This resulted in confusing battles where luck and chance held far too much sway. To avoid such an uncontrolled and uncertain environment the Canadians came to the realization that they had to amass as much information on the enemy as they could prior to assaulting. From this information Canadian planners prepared extensive, finely-tuned, and detailed plans whose execution reduced battlefield confusion and the reliance on good fortune when communications collapsed. From this awakening onwards, the desire to be fully informed permeated all Canadian planning, and drove them to learn everything possible about the enemy, the terrain,

and their assigned objectives. Like so much else, though, this lesson had to be learned through the hard hand of war.

The Canadians who arrived in France in early 1915 were a zealous lot, and craved a fight. Such a martial spirit is an attractive quality for soldiers to possess but, in the Canadians' case, it also blinded them to some of the realities of modern trench warfare and the use of intelligence. At the Battle of Neuve Chapelle, beginning March 10, 1915, Canadian ardour cancelled out any concern they might have harboured over their lack of preparation. Although in the end the Canadians did not fight in this battle, they were certainly willing to do so, despite being unprepared and ignorant of the German defence. Canadian involvement at Neuve Chapelle began on March seventh, when the 4th British Corps informed the Canadians of their role in the up-coming battle. The Canadians were to prepare a demonstration in order to deceive the Germans as to the location of the real (British) attack, occupy their attention, and hold them on the Canadian front so that they could not reinforce the actual threatened sector.¹ On the ninth, Major-General E.A.H. Alderson, the division commander, warned subordinate commands to be ready to launch assaults the next day should the British effort meet with success.² The Canadian division had about forty-eight hours to prepare for a possible assault that the British had been planning since February sixth. Yet they raised no objections. Quite the opposite occurred, as all ranks were imbued with the fighting spirit and a desire to show their mettle. It did not matter to the Canadians that they did not know what their objectives were for such an assault. The division, through Operation Order No. 5, told the 3rd Canadian Brigade, for example, that "it is impossible to say at present what will be the objective of this Division should it be

¹ Fortescue Duguid, *Official History of The Canadian Forces in The Great War 1914 - 1919, Chronology, Appendices, and Maps* (Ottawa: King's Printer, 1938), Vol. 1, appendix No. 284.

² *Ibid.*, No. 285.

ordered to assume the offensive,” although the likely point of contact was described. “[Y]ou [the brigade commander] should therefore carefully reconnoitre the ground with a view to massing two battalions along the RUE DU BOIS, or nearer.” Divisional headquarters further advised the brigade to warn battalion commanders occupying the area

to look carefully at the ground between them and the enemy’s trenches. It should be considered best how our own wire could be traversed, how grenade detachments can best be utilized, how covering fire can be directed and how the enemy’s trenches when taken can be held and strengthened.³

None of this was bad advice in itself, but all of it should have been carried out long before the assault was to commence, and as a matter of routine upon entering a new sector. The Canadians had been in the line for a week, and Alderson’s note suggests that the Canadians had not reconnoitred their front, nor compiled an intelligence profile of the German positions and the intervening terrain. In fact, company commanders only received field telescopes on the day of the attack, indicating that no detailed observation of the enemy position by officers charged with making any called-for assault had previously occurred.⁴ It was only after the instructions to study the ground were issued that, as the official history points out, “scouts reconnoitred the area immediately in front where they found a water-filled ditch eight feet wide and four deep, which would be a serious obstacle to be crossed in the first rush.”⁵ Had the Canadians attacked in this location German

³ Ibid., No. 286.

⁴ National Archives of Canada (NAC), Record Group (R.G.) 9 III D3, Vol. 4918. Eighth Battalion War Diary, March 1915. At first telescopes were issued only to signallers, and so observers had to borrow them. H. Hesketh-Prichard, *Sniping in France. How the British Army Won the Sniping War in the Trenches* (Reprint, USA: Lancer Militaria, 1993), 5.

⁵ Fortescue Duguid, *Official History of The Canadian Forces in The Great War 1914 - 1919* (Ottawa: King’s Printer, 1938), Vol. 1, 190.

machine guns most certainly would have inflicted serious losses on the advancing troops, who at this point in the war still advanced in fairly tight waves. Yet the revelation of the water-filled ditch did not alter any Canadian plans. As events turned out, the British assault was not successful enough to warrant a Canadian advance, which was a good thing for the Canadians. Indeed, the diarist for the 14th Battalion noted that any Canadian attack at Neuve Chapelle “would have been a difficult operation unless the Germans opposite us were attacked on their flank, as the wire in front of the German trenches had not been shelled, and was uncut.”⁶

The next month, April 1915, the Canadians fought their first major battle. At Second Ypres the Canadians were the targets of a German poison gas attack that severely tested their fighting capabilities. While the troops proved brave enough, the Canadians’ intelligence system failed utterly to discover the German plans, even though the evidence pointing to an attack, when viewed today, seems overwhelming. The result was a near disaster for the Canadian command, one that was only averted by Canadian tenacity, and the quick support of British troops rushed to the scene. Unfortunately, some 6,000 Canadian casualties occurred. Contributing to the debacle was the near total collapse of the communications system. For the most part, news dealing with events forward of battalion simply did not make it back to rear area commanders. The intensity of the German assault prevented runners from penetrating the fire zone, obscured flag and lamp signals with dust and smoke, and severed telephone lines at the outset. Controlling the action proved well-nigh impossible.

On April fourteenth, eight days prior to the German offensive, the Canadians learned from the British 5th Corps of the possibility of a German gas attack. The next day the corps informed the 1st Canadian Division that it was “not

⁶ NAC, R.G. 9 III D3, Vol. 4922. Fourteenth Battalion War Diary, March 10, 1915.

possible to test its [the report of a possible poison gas attack] credibility but certain facts tend to corroborate it. The Corps Commander directs that all precautions are to be taken which would be taken if its credibility were established.” Some of the clues offered as proof of a possible attack included reports that the Germans had brought up additional reinforcements and artillery. The corps’ note ended with a warning that “It is possible that the attack may be postponed, if the wind is not favourable, so as to blow the gases over our trenches.”⁷ Other warnings arrived at the British and French headquarters. A German deserter taken by the French on the thirteenth gave the details of the proposed attack, although the story of a second deserter captured by the French a few days later offered contrary information. This, along with the RFC’s failure to observe any inordinate German activity, and the failure of the German assault to materialize when first expected (during the night of April 15-16), relaxed the vigilance of Allied commanders. The warning that the Germans required a favourable wind -- something that did not occur on the original assault date -- was forgotten. By April twenty-second, the British had switched their attention to another portion of the line.⁸

The Canadians, taking their cue from their British superiors, also stopped worrying about a German poison gas attack. However, the Canadians must accept their share of the blame for misreading the evidence. Canadian reports to the British 5th Corps presented a mixed, if not a confusing, picture of the actual front

⁷ NAC, Manuscript Group (M.G.) 30 E61 (Mitchell Papers) Vol. 4, Folder 17. British V Corps to 1st Canadian Division, April 15, 1915.

⁸ A number of books describe in greater detail the various warning signs that were known by the Allies. See for example: Duguid’s, *Official History*, 212-220; G.W.L. Nicholson, *Official History of the Canadian Army in the First World War. Canadian Expeditionary Force 1914-1919* (Ottawa: Queen’s Printer, 1962), 60-61; Daniel Dancocks, *Welcome To Flanders Fields* (Toronto: McClelland & Stewart Inc., 1989), 153-155; George Cassar’s, *Beyond Courage. The Canadians at the Second Battle of Ypres* (Canada: Oberon Press, 1985), 58-63; and J. McWilliams and R.J. Steel’s, *Gas! The Battle for Ypres, 1915* (St. Catherine’s, Ont.: Vanwell Publishing Limited, 1985), 11-20.

line situation. Between April sixteenth and twenty-second, for example, the Canadians described a number of suspicious occurrences and activities. Front line units reported heavy German transport, drums and rail traffic behind the German lines, along with sightings of a German observation balloon actively reconnoitring the Allied position. Other reports claimed German shells landing on Canadian positions on the nineteenth emitted “fumes of an asphyxiating nature,” with others still saying the situation was normal, unchanged or quiet.⁹ The Canadians passed these mixed messages on to the British for assessment, where their inconclusive nature must have relieved British decision-makers of some of their anxiety, while reassuring them that a German assault was not in the immediate offing.¹⁰

How the Canadians determined what was normal German shelling is not entirely clear, as they were new to the Ypres sector, and had only completed their relief of the French on the seventeenth (the relief began on the fourteenth). Later in the war, when shelling maps and other intelligence reports, logs and lists were available and handed over to incoming troops, such a determination would have been a relatively simple one to make.¹¹ Shelling maps, for instance, were later used to record the landing site of each German shell fired. It was then just a matter of reviewing the maps and other lists for several of the past weeks to see a visual representation of German bombardment patterns. Such an elaborate tracking system did not exist in April 1915, so determining what was normal shelling would have been more difficult. In their defence, however, the Canadians were told by

⁹ NAC, R.G. 9 III D3, Vol. 4823. 1st Canadian Division War Diary, April 1915; also 2nd Brigade War Diary, April 1915. The 2nd Canadian Brigade recorded on the nineteenth and the twenty-first that heavy shelling occurred on some portions of the line, and that on the twentieth, German artillery had searched out Allied howitzer emplacements. On the nineteenth, sounds of German work parties driving stakes for wire entanglements were heard. Yet at the same time the situation was said to be normal or unchanged.

¹⁰ NAC, R.G. 9 III C3, Vol. 4009, Folder 11, File 4. The divisional Intelligence Summary for April 18th offers a case in point.

¹¹ By September 1915, the Canadians were counting shells landing in their sector, NAC, M.G. 30 E236 (Villiers Papers) Vol. 1, Folder 2.

the outgoing French command that Ypres was a quiet sector, and so the Canadians may have mistaken the intensified German shelling for normal, or at least, non-threatening fire.¹²

A report by Captain Rae of the 16th Battalion on April twentieth should have raised a few eyebrows. After the war Rae claims to have reported seeing an altered appearance to the German parapets.

On going into the line I made a close study of the German trenches on my front, and on the morning of the 20th I noticed a very surprising change in the appearance of the German parapet. The whole top appeared to have been pulled about and altered, and there were various openings in it unlike anything I had ever seen before. I was so impressed with this that I sent in a special report to the battalion commander.¹³

Rae seems to be describing apertures cut in the German trenches to afford easy egress for assaulting troops, or perhaps fissures in which to lay gas cylinders. Unfortunately what, if any, action was taken by the Canadians is unknown. The report was supposedly investigated, although neither the report nor any mention of its consequences could be found in the records. Whether Rae's concern over the altered appearance of the trenches was passed on to the incoming command during the battalion's relief is also unknown. However, Lieutenant Colonel J.A. Currie, the commander of the 15th Battalion, says he personally inspected the trenches on the night of the twenty-first, but does not mention any strange appearance to the German parapets.¹⁴

To be sure, the Canadians were trench neophytes in April 1915, and this no

¹² Duguid, *Official History*, 204. The French stated that the battalions holding the line had suffered fewer than thirty casualties since Christmas.

¹³ NAC, R.G. 24, Vol. 2680, Folder 2, File HQC-49 50-Vol. 2. W. Rae to Duguid, June 29, 1926.

¹⁴ NAC, R.G. 9 III C3, Vol. 4077, Folder 3, File 7. Entry in Army Book 152 for April 29, 1915; also in R.G. 24, Vol. 1822, File GAQ-5-29. Lieutenant Colonel Currie to the 3rd Brigade, May 6, 1915.

doubt helps explain why they did not see the evidence of a German assault for what it was. Victor Odlum, the senior major in the 7th Battalion, wrote after the war that he saw little that could be interpreted as an offensive threat. Odlum remembered that German activity simply did not suggest that an attack was pending. He recalled that

The enemy made no attempt to interfere whilst the British were taking over the new front, and appeared to be devoting his efforts to strengthening his line; his wire entanglement grew every night, and every morning his parapets showed fresh signs of having been thickened. He sent out few patrols, and those few were unenterprising.¹⁵

Captain Paul Villiers, then the 3rd Brigade's machine gun officer, agreed. He wrote in his diary - memoir: "There were signs of unusual activity during the proceeding [sic] days, but these were not interpreted as indicating anything unusual."¹⁶

The condition of the French trenches that the Canadians took over contributed to the Canadians' poor overall intelligence performance. Defensive methods practiced by the French and British differed enormously. The French did not pack their front trenches with men the way the British did. In fact, the French barely used trenches at all. Instead, they employed a more open defence that utilized the full fire-power of their famous 75 millimeter field guns. The Canadians, after assuming control of the lines, had to rebuild the trenches to meet British standards, and this required a tremendous number of man-hours. Moreover, the surroundings were littered with all manner of filth and decaying bodies left unburied since 1914, and this too had to be cleaned up.¹⁷ As a result,

¹⁵ NAC, M.G. 30 E300 (Odlum Papers) Vol. 16, Folder: The Battle of Ypres, April 1915. This is from his unpublished post war monograph, chapter 7, page 5.

¹⁶ NAC, M.G. 30 E236 (Villiers Papers) Vol. 4, Folder 7. Diary, April 1915.

¹⁷ NAC, R.G. 24, Vol. 1820 Folder 5-10. Report by Major H.H. Matthews; Nicholson, *Official History*, 56-57.

most of the Canadian effort in the days and nights prior to the German assault went into correcting the trench defences. As Major H.H. Matthews, an officer in the 8th Battalion, observed: "All the men except those on actual sentry [duty] were busily employed each night on working and fatigue parties improving the defences, carrying in food, water and ammunition, and getting out a few wounded men."¹⁸ Without an organized battalion level intelligence section devoted to full-time intelligence work, there were simply too few men available after the working parties were organized to conduct a systematic surveillance of the German lines and the intervening ground. Intelligence work, of course, did occur, but company commanders, the officers responsible for organizing patrols, observation and listening posts, had too much else to do, and too few men to do it with, to ensure that intelligence collection received its proper attention.

When the German assault came on April twenty-second, it was a total surprise. The French Army, to the Canadians' left, disintegrated when the chlorine gas cloud drifted over its position, opening up a 4,000 metre gap in the Allied lines. The 3rd Canadian Brigade had to extend its left flank to plug the hole. After severe fighting they, along with the British reinforcements rushed to the scene, stemmed the German tide. Two days later the 2nd Canadian Brigade felt the full weight of the next German gas attack. Chlorine gas and German artillery fire smothered the forward Canadian positions, cutting most of their communications within the first fifteen minutes of the assault. Commanders from battalion back to division were thrown into the dark. The embryonic intelligence service tried to shine light on the subject, but was overwhelmed. Reports from Army headquarters and neighbouring British and French commands arrived at divisional headquarters, but they could not clarify the tactical situation up the line. Not even aerial observation was of much help to the division, even though the battle saw one of the first occasions where

¹⁸ NAC, R.G. 24, Vol. 1820, File 5-10. Major H.H. Matthews to Lt. Col. Lipsett.

aircraft reported on ground action. Unfortunately, the observer following the fighting mistook some German troops for British, and so gave incorrect news to the imperial and Canadian troops on the scene.¹⁹ With word from the front unable to reach divisional headquarters, General Alderson, rather than sit passively waiting for news to come to him, sent forward staff officers to collect whatever news they could muster. The double staffs of the Canadian division (for example, two GSO2s, and two GSO3s) eased the burden of these officers, as they could work in shifts, and around the clock. Lieutenant Colonel C.H. Mitchell, the divisional intelligence officer, worked almost non stop, and was regularly seen at the front visiting brigades and battalions in the line.²⁰ From the information he collected he prepared a series of situation maps that showed the positions of the opposing armies at different times throughout the action.²¹ But in the end his efforts, while valuable and valiant, could not dissipate the shroud of fog covering divisional command -- a fog that forced Alderson to make decisions without adequate information.²² Artillery support also suffered because the gunners were unsure of the location of friendly troops.

Meanwhile, staff captains(I) played only a minor intelligence role during the battle. In the 3rd Brigade the bulk of the intelligence work, as a perusal of the field messages demonstrates, was handled by the brigade major and the brigade commander, not the staff captain(I). The staff captain(I), though, did make a

¹⁹ S.F. Wise, *Canadian Airmen and the First World War, The Official History of the Royal Canadian Air Force Vol. 1* (Toronto: University of Toronto Press, 1980), 346. An inauspicious beginning for the use of aerial observation. As Wise writes: "Such misfortunes did nothing to develop staff confidence in airmen as reporters of the ground battle."

²⁰ NAC, R.G. 24, Vol. 2680, Folder 2. File HQ C - 49 50 - Vol. 2. Mitchell to Duguid, June 12, 1926.

²¹ NAC, M.G. 30 E61 (Mitchell Papers) Vol. 18. Various situation maps, timed and dated: April 22nd, 4 and 10 p.m., April 23rd, 3 and 7 a.m., April 24th, 9 a.m., April 25th, 4 a.m., noon, April 26th 9 a.m., April 27th 6 a.m.

²² Duguid, *Official History*, 414 - 417.

number of reconnaissance patrols to determine the location of new positions, and acted as a guide on the night of April twenty-second for counter attacking forces trying to reach their assembly areas. Later in the battle he was evacuated wounded, but before that time he also carried messages to the 2nd Brigade. And while the staff captain(I) may have made a worthy contribution, none of his tasks were really any different from those of other officers, and none required special intelligence skill. The brigade staff captain(I) was merely one officer among several, all trying to ascertain the conditions along the front so as to keep the commanding officer informed.

The 2nd Brigade's staff captain(I), Captain Ross Napier, played an almost non-existent intelligence role. Other than conducting a reconnaissance during the evening of April twenty-second, he spent most of the battle at the brigade's rear area administrative headquarters rather than at the advanced headquarters where most of the action and brigade decision making occurred. Brigadier-General Arthur Currie and his brigade major received and handled the brigade's combat intelligence during the fighting. After his brigade major was wounded, Currie acted as his own intelligence officer very much in the tradition of nineteenth century commanders. On the twenty-third, for example, he visited every OP in his brigade area to see for himself what ground to hold, and to see how events were unfolding along his front. This style of command fitted Currie's disposition, for he was an officer who liked being fully informed, and to see things first hand. He received reports, made evaluations on the spot, and undertook personal reconnaissances. Meanwhile, Napier remained in the rear headquarters, even after most of the 2nd Brigade's staff stationed in the foremost headquarters became casualties. But then, as Napier himself explained: "There was neither time nor opportunity for [the] replacement [of these officer casualties] and we [Napier and Clark, the senior staff captain] had to assume all and every duty that came to hand. Of necessity we were separated,

Clark being with the Brigadier.”²³ It is interesting commentary on the value attached to the brigade staff captain(I) when the administrative staff captain goes forward with the commander while the intelligence staff captain handles administrative functions in the rear, especially in a battle as confused as Second Ypres.

Having an intelligence officer in a rear area headquarters may have had some advantages. The rear HQ might have acted as an information conduit for messages and intelligence received from across the front, and beyond the 2nd Brigade’s command area. Napier might then have kept Currie informed of the changing situation from a broader perspective. However, Napier appears not to have been utilized in this capacity either. In the rear headquarters he was out of touch with events along the front, and was of no value as an intelligence officer. Of an admittedly small sample of just thirty-six field messages that are either addressed to, or signed by, Napier between April 22-30, 1915, only a handful concern tactical intelligence matters.²⁴ Two deal with reinforcements, eighteen with casualty figures, seven focus on the actual situation and plans of the brigade, one on an expected German attack, six on equipment, rations and ammunition concerns, one was a note of thanks, and one with the brigade’s relief. Individuals seeking information about the brigade’s situation did not ask Napier, they asked Napier to contact Currie. In any case, Napier was in no position to answer queries regarding the front, as he was out of the information loop. A message to Currie from Napier on April twenty-fourth at 1630 hours demonstrates that he could not even give an

²³ Wilfrid Bovey, “Sir Arthur Currie: The Corps Commander,” *The Legionary*, (July 1934): 5-7. Here Bovey is quoting Napier.

²⁴ NAC, M.G. 30 E74 (Urquhart Papers) Vol. 1 Folder 3: Field Messages, 2nd Brigade, April - May 1915. The small number of field messages addressed to, or written by, Napier may itself be proof that he played a minor role in the brigade. Interestingly, in Duguid’s *Appendices* there are no messages addressed to or by Napier.

inquiring officer details of a proposed counter attack involving his own brigade.

Napier asked Currie:

Can you advise at what hour counter attack is to take place this evening for information of O.C. of troops which are here to support you AAA OC 3rd Canadian Artillery Brigade sends following message AAA Begins 'Can you give me any idea of the situation AAA We are carrying on shelling C11.6 and C12A AAA Is this safe for our troops[?] AAA Can you tell me anything of the line or likely attack please.' AAA ends AAA Please instruct as to reply AAA.²⁵

Napier was an out of touch intelligence officer. It is interesting to observe that when Mitchell visited the front in search of information during the battle he did not mention visiting Napier or any other staff captain(I). He does mention visiting Currie and Brigadier-General Richard Turner, the brigade commanders, and Garnet Hughes, the 3rd Brigade's brigade major.

Forward of battalion all was pandemonium. Lieutenant Colonel George Tuxford, commanding the 5th Battalion, recalled after the war that conditions in front of his battalion were chaotic. Handfuls "of disorganized men, sticking it out, having practically no orders, out of touch, and not knowing anything about the situation, nor knowing what to do or where to go" hung on in desperate conditions.²⁶ Other battalions suffered a similar fate, as battalion commanders had little idea of events surrounding them. Commanders sent out patrols and scouts to learn the situation, but their efforts were often hampered by German fire. Sometimes patrols failed to locate anything, and at other times simply disappeared without a trace.²⁷ Battalion officers seeking news also went forward, including the

²⁵ NAC, M.G. 30 E74 (Urquhart Papers) Vol. 1 Folder 3: Field Messages, 2nd Brigade, April - May 1915. To O.C. 2nd Brigade 4.30 p.m. April 24.

²⁶ NAC, R.G. 24, Vol. 2680, Folder 2, File HQ C - 49 50 - Vol. 2. Tuxford to Duguid, July 19, 1926.

²⁷ NAC, R.G. 9 III C3, Vol. 4077, Folder 3, File 8. Company report, 15th Battalion. M.G. 30 E 300 (Odium Papers) Vol. 16, Folder: No. 1 Company, 7th Battalion, April 22-26, 1915.

7th Battalion's commander, Lieutenant Colonel W.F.R. Hart-McHarg who was killed in the attempt. In the interim, it took hours for runners and signallers to get their messages through, if they got through at all. Simply put, the Canadians were caught unprepared for such a catastrophic collapse in their communications system, and were without means to circumvent it. The result was that the intelligence necessary for command and control purposes was often unavailable to those who required it, or was obsolete and of doubtful quality by the time it arrived.

By the time the Canadians entered the fighting around Festubert in May, they were battle hardened troops. At Festubert they were on the offensive, and were no longer quite so willing to assault entrenchments without first thoroughly investigating and studying them beforehand. On at least two occasions, Canadian brigade commanders sought attack postponements in order to more exhaustively reconnoitre the enemy lines. Both times they were rebuffed by a divisional headquarters anxious to carry out its assigned orders. The official historian described Festubert as "the most unsatisfactory engagement of the 1st Canadian Division in the war," and not just because the Canadian assaults ultimately failed, and at a cost of 2,468 casualties.²⁸ The Canadians lacked specifics on their objectives and knew little about the German positions and the intervening terrain. An assault by the 3rd Canadian Brigade on the eighteenth was stopped dead in its tracks by previously undisclosed machine guns.²⁹ On the twentieth the brigade attacked once more. Its objective was an orchard and an unidentified position marked M.10. on trench maps. Prior to the assault a reconnaissance by Lieutenant Colonel W.R. Marshall, commander of the 15th Battalion, discovered "tall uncut wire covering the German position." Turner, the brigade commander, upon hearing this sought postponement of the attack, as the wire was certain to cause

²⁸ Duguid, *Official History*, 498.

²⁹ Nicholson, *Official History*, 98.

failure. Divisional command, however, informed Turner that the orders to attack remained. D.J. Goodspeed, in his book *The Road Past Vimy*, blames higher British command for this order, stating: "The Canadian Division was peremptorily ordered to attack once more in broad daylight."³⁰ In full view of German machine gunners, men from the 3rd Brigade left their trenches and crossed the open fields towards their objective. On the right the attack fell short by about 100 yards; on the left, after securing the orchard, the troops discovered that M.10 was in fact a fortified house containing machine guns and surrounded by wire. There the assault failed. The brigade suffered around 250 casualties in assaulting unidentified positions over strange ground.³¹ Intelligence that warned of potential disaster had been disregarded in favour of proceeding with the larger plan.

A separate attack was launched by the 2nd Brigade on the twentieth. Its objective was K.5., a position that Brigadier-General Currie could not identify even after personally viewing the ground from an artillery observation post. Divisional headquarters told him that K.5. was a strong point, but of what nature nobody could say.³² He asked for a day's delay in order to more thoroughly study the situation, but he too was told by division that the attack would proceed as ordered. After the war he wrote that he "protested on the grounds of insufficient time for reconnaissance and preparation. I now know better than ever that I was right, but still I was ordered to make the attack."³³ In fact, the brigade's after action report says that no reconnaissance was made.³⁴ The 2nd Brigade's assault failed, as did

³⁰ D.J. Goodspeed, *The Road Past Vimy. The Canadian Corps 1914 - 1918* (Toronto: Macmillan of Canada, 1969), 43.

³¹ Duguid, *Official History*, 473-474.

³² Goodspeed, *The Road Past Vimy*, 44. Goodspeed says that K.5. was actually "a narrow sector of the enemy line with no distinguishing feature of its own."

³³ Hugh M. Urquhart, *Arthur Currie. The Biography of a Great Canadian* (Toronto: J.M. Dent & Sons (Canada) Limited, 1950), 106-107.

³⁴ NAC, R.G. 24, Vol. 1883, Folder 5, File 8. "Narrative of Events Festubert Action 19th. to 26th. May, 1915. 2nd Canadian Infantry Brigade."

the one the next day. The Canadians did not take K.5. until May twenty-fourth, after a pause was finally granted by the 1st Army to allow for a thorough reconnaissance of the position by officers of the 2nd Canadian Brigade. Plans for the capture of K.5 were based on these reconnaissances and other earlier observations.³⁵ Currie's request on May twentieth for a deferment to allow time for a more thorough study of the latest intelligence was vindicated. An attack on the twenty-fifth to clear another section of trench by Seely's Detachment -- cavalrymen who volunteered to serve as infantry -- also ended in failure. Seely's Detachment reported that it had cleared its assigned trenches; however, its assessment was incorrect. "Being completely unfamiliar with the ground, and having totally inaccurate maps, they had lost their way and had actually worked their way along the wrong trench!"³⁶

Poor communications added to the Canadians' difficulties. This hindered the flow of intelligence, and affected command and control. However, General Alderson, in an effort to avoid the confusion that attended the Canadian efforts at Second Ypres, prearranged to have staff officers move forward with the assaulting troops to monitor the fighting from some safe distance. By actively seeking news this way Alderson freed himself, to a degree, from a reliance on the word of officers and men burdened with the actual fighting.³⁷ Also accompanying the infantry were FOOs who went forward to help control the artillery fire, and to ensure that the infantry were not without artillery support when they needed it. Through these means the Canadian command tried to keep abreast of the situation in

³⁵ Duguid, *Official History*, 475-480, 485-488.

³⁶ John Martinson, "Entry Into the Great War 1914 - 1915," Chapter 5 in *We Stand On Guard. An Illustrated History of the Canadian Army*, eds. Martinson et al. (Toronto: Ovale Publications, 1992), 120.

³⁷ It was only natural that Mitchell was one of these officers. See Duguid's *Appendices*, number 784. The whereabouts of brigade staff captains(I) during this battle could not be determined, and were not discussed in the sources reviewed.

order to retain some control over the action.³⁸

The appallingly inaccurate maps used by the Canadians at Festubert made a bad situation worse. The problem was that at the war's outset the British did not possess detailed, up to date maps of northern France and Belgium. A 1/80,000 scale French map was available, as was a 1/100,000 scale map of Belgium and northern France. Both were years out of date and inaccurate. Some features, such as crossroads and churches, were only plotted to within fifty yards of their actual positions. This would have been only a minor concern in open warfare, but for trench warfare, with its all-consuming need for detail, it was entirely insufficient. Unfortunately, until such a time as British surveyors could map the front for themselves, old French and Belgian maps and surveys had to suffice. To meet the need for large scale maps, French and Belgian maps were simply enlarged to 1/40,000, or some other scale. The process compounded inaccuracies, sometimes by as much as 450 yards.³⁹ At a time when an infantry assault could barely manage a 450 yard advance, an error of this magnitude could be devastating. It was these enlarged, error-filled maps that the Canadians used at Festubert. Rendering the maps more useless was the fact that in the process of enlargement the maps were printed upside down, with North at the bottom and East on the left. Map coordinates were also reversed from standard practice. The artillery, already hampered by out of date gunnery practices, could not easily compensate for map anomalies. Moreover, the same map symbol represented different features, so exact objectives were not always clear to attacking troops. As we have seen, some positions were simply labeled K.5., or some other alpha-numeric code, without any

³⁸ NAC, R.G. 24, Vol. 1883, Folder 5, File 8. "Narrative of Events Festubert Action 19th. to 26th. May, 1915. 2nd Canadian Infantry Brigade." General Currie complained that FOOs did not go far enough forward, and so could not effectively redirect friendly shell fire that landed on his brigade.

³⁹ Jeffrey S. Murray, "British-Canadian Military Cartography on the Western Front, 1914 - 1918," *Archivaria*, 26 (Summer 1988), 52-65.

description. The Canadians tried correcting the maps with overlays drawn from aerial photographs, but these just added to the confusion. The overlays did not fit correctly, and some features appeared twice. Captain Villiers wrote that “These maps did more to muddle young officers, and old ones too, than anything else,” and one is hard pressed to disagree.⁴⁰

The intelligence problems confronting a subordinate command are also demonstrated at Festubert. “The Army Commander [General Sir Douglas Haig] was insistent that, whatever the obstacles, forward progress must speedily be made.”⁴¹ Goodspeed argues that the Canadians’ failure to take their objectives “called down Sir Douglas Haig’s wrath on May twenty-second and which led to his ordering yet further attacks.”⁴² Haig was schooled in a prewar army that viewed the capture of ground as the mark of success. With such an outlook combat intelligence took a back seat, as bull-headedness and the determination to see the job through were seen as keys to victory. Problems simply had to be overcome. Telling lower level commands to overcome difficulties certainly bestowed a fair degree of initiative on those commands; unfortunately, restrictive and arbitrary timetables set by higher commands, and the unwillingness of these commands to put off assaults when the need for intelligence was acute, or when intelligence suggested a postponement might be wise, rendered such initiative moot.

Despite all the problems encountered at Festubert, it was an important battle in the Canadians’ development. It was an example of what not to do. In the future, the Canadians paid great attention to detail. The collection and study of information on the enemy line became a Canadian priority. Pre-planning helped reduce

⁴⁰ NAC, M.G. 30 E236 (Villiers Papers) Vol. 4. Diary, May 1915. S.R. Elliot, *Scarlet to Green. A History of Intelligence in the Canadian Army 1903 - 1963* (Toronto: Canadian Intelligence and Security Association, 1981), 27.

⁴¹ Duguid, *Official History*, 481.

⁴² Goodspeed, *Road Past Vimy*, 45.

battlefield confusion and loss of control, for then commanders could make most of their crucial decisions in the relative calm of normal trench warfare, instead of during the heat of battle. The thorough study of intelligence also ensured that fewer unforeseen obstacles were encountered during an offensive. Precision planning, too, meant that a complete breakdown in offensive action was less likely to occur should communications fail on the day of truth, as officers and men knew in advance what was expected of them.

At Givenchy, in June, the Canadians put these ideas into practice. Thorough study was the rule, and as poor weather postponed the assault several times, the Canadians were blessed with more time for preparation than they first expected. This, no doubt, pleased General Currie, who had earlier sought a deferment in the assault date to allow for a more thorough reconnaissance. As at Festubert, however, division denied Currie's request, and in the process he "got rapped over the knuckles" for asking.⁴³

The Canadians used the time wisely to gather and study intelligence and the ground over which they would assault. To ensure that the Festubert map fiasco did not repeat itself, "every Platoon Commander and all Staffs from Battalion rearward," wrote Currie after the war, "had copies of a panorama sketch of the battle ground and objectives made by an Intelligence Officer from a house situated in the centre of the village."⁴⁴ Three eighteen-pounder field guns, concealed in and near the front line trenches, were available to deal with any undiscovered or unscathed German positions encumbering the advance. Rubber wheels on gun-carriages and limbers muffled the sound of rumbling wheels over the cobblestone streets. When weather permitted, the RFC extensively photographed the area for Canadian planners. These photographs were of enormous help for unravelling the

⁴³ Urquhart, *Currie*, 106-107.

⁴⁴ Currie, "Historical Resume," xvii; Elliot, *Scarlet to Green*, 27-28.

secrets of the German lines.⁴⁵ Patrols and photographs revealed the locations of front line German machine gun nests, which the gunners then targeted for destruction on the day of attack. The Germans' use of various coloured sandbags (blue, red, purple, white) added to the Canadians' difficulties in identifying and ranging positions, but the Canadians persevered.⁴⁶ No detail seemed too small. The 4th British Corps, under whom the Canadians were then serving, wrote to the Canadians:

The air photographs and large scale maps now available admit of the plan of operation being worked out in very great detail previous to the attack, and under present conditions in which communication is so difficult, it is essential that this should be done by the Commanders concerned who must satisfy themselves that every detail has been considered.

All officers must study the ground in front of our trenches and mark on their maps the enemy's wire and all obstacles, keeping the map up to date. It is of particular importance to obtain information of the enemy's maxims [i.e., machine guns]! Maxims and wire are usually the greatest difficulties encountered in an advance.⁴⁷

The result of all this study was an informed assault force, one that could proceed as scheduled, even if its officers were lost to enemy action. The official history records, for example, that on June fifteenth, men from the 1st Brigade's 1st Battalion, packed and waiting in assembly trenches, were shelled with the loss of three officers killed and several wounded; yet, "there was no serious confusion or delay: the leading company...dashed across No Man's Land promptly at 6.01 p.m., followed a few minutes afterwards by [a second company], and as [previously] instructed they went straight through to the German second line."⁴⁸

⁴⁵ NAC, R.G. 9 III C3, Vol. 4011, Folder 15, File 9. 1st Army to IV Corps, June 19, 1915.

⁴⁶ Goodspeed, *Road Past Vimy*, 49.

⁴⁷ NAC, M.G. 30 E300 (Odlum Papers) Vol. 23, Folder: 'Attack,' operation orders, 1915. IV Corps to 1st Canadian Division, June 7, 1915.

⁴⁸ Duguid, *Official History*, 513 - 514.

The progress of the attack was monitored by staff officers⁴⁹ who, with their signallers, kept division command informed. At the same time, FOOs followed and accompanied the advance, and called for both artillery support and any necessary corrections. To mark their advance for observers, men in the assaulting units carried blue flags.⁵⁰ Through these means the Canadians, slowly but surely, were working out a system for carrying information during a battle from the sharp edge to commanders in the rear.

Eventually, however, the Canadian attack faltered. The Germans had been expecting it. Canadian wire cutting bombardments in the days and hours leading up to the advance had clearly demarcated for the Germans the boundaries of the impending blow. The increased intensity of Canadian shelling just prior to the onslaught told the Germans that the moment of truth had come. There was no surprise. A mine explosion detonated by the British complicated the assault in unexpected ways. Moreover, Canadian planners did not entirely understand German defensive tactics. British and Canadian planners regarded front line obstacles and trenches as the most important artillery targets, so the bulk of friendly artillery fire was allotted to these positions. Meantime, the Germans had placed large numbers of machine guns and supporting troops in a secondary line of defence, out of harm's way. German counter attacking forces formed up unmolested, and they inflicted a devastating assault before the Canadians had regrouped and consolidated their gains. The Germans recaptured all their ground. Nor was German artillery especially targeted; and being unmolested it inflicted considerable casualties on the Canadians in their assembly areas and as they

⁴⁹ Duguid's *Official History*, 517, does not identify the "Canadian staff officer" who was reporting on the battle's progress. It may have been Lieutenant Colonel Mitchell in a repeat performance of his role at Festubert. Also, both the official history and the primary sources are silent on the whereabouts of the 1st Brigade's staff captain(I) during this engagement.

⁵⁰ Goodspeed, *Road Past Vimy*, 51.

advanced across no man's land. During the German counter attack no Canadian SOS mission was called, saving the German counter attacking forces from Allied guns.⁵¹ Despite the Canadian defeat, however, lessons were learned, perhaps the most important being the Canadians' recognition that intelligence, and thorough planning based on that intelligence, was crucial to success. Rather than seeing their defeat at Givenchy as an intelligence failing, the Canadians took heart from their near success and became convinced that more intelligence, more study, and more planning was required in the future. The planning that went into the Givenchy offensive, therefore, ushered in a new era for Canadian combat intelligence gathering. As the official history notes: Canadian planning at Givenchy was "in many respects the prototype in miniature of successful major engagements later fought by the Canadian Corps."⁵²

After Givenchy it is not surprising to see the Canadians being even more aggressive in collecting intelligence. It was in this enhanced and favourable intelligence environment that the Canadian Corps introduced the trench raid to its members. Raiding was a proactive intelligence gathering activity, designed to secure intelligence by force of arms. The Canadians were not the first to use raids on the Western Front, but their first trench raid, launched in November, was larger, more detailed, and more successful than any raid that had gone before. It became the archetype for all future Canadian raids. Specifically, the raid's success resulted from close liaison between the infantry and the artillery, careful training, detailed orders, and "the thoroughness with which the enemy's position had been scouted in advance."⁵³

The raiders had three main goals: to secure intelligence by capturing

⁵¹ Duguid, *Official History*, 511-513, 520-521. Nicholson, *Official History*, 106.

⁵² Duguid, *Official History*, 502-521.

⁵³ Nicholson, *Official History*, 123 - 125. Martenson, *We Stand On Guard*, 130.

prisoners and searching and sketching the enemy's trenches and dugouts; to force the Germans to bring up their reserves so that the artillery might inflict casualties among them; and to lower German morale through hit and run tactics. Men from the 7th and 5th Battalions performed the task. The operation was an enormous success, despite the 5th Battalion's inability to enter the German trenches. The 7th Battalion more than made up for the 5th Battalion's setback: its raiders breached the enemy's trenches, surprised the garrison and inflicted considerable damage, killing and wounding approximately thirty Germans.⁵⁴ Twelve prisoners were captured from whom valuable information was gained on German relief policy, routes of approach, rear area activity, trench garrisons, defensive layouts, machine gun emplacements, LPs, patrol policy, and morale.⁵⁵ Also captured were some of the German new-style rubber gas-masks, a significant intelligence coup. Moreover, the raiders learned something of German trench construction techniques, information that was valuable in determining how best to destroy them. This intelligence bonanza cost one man accidentally killed, and another slightly wounded.

Ironically, raids for the purpose of gaining information on an enemy position demanded a tremendous amount of intelligence prior to their launch. This was because raids, although termed minor operations, were really small scale set-

⁵⁴ NAC, R.G. 9 III D3, Vol. 4826, 1 Division War Diary, November 1915, Appendix 17. "Canadian Corps Report on Enterprise at la Petite Douve by 2nd Canadian Infantry Brigade, November 17, 1915." Fifty casualties were inflicted on the Germans according to the raiders, but General L.J. Lipsett thought thirty was a safer number to report, as it was his experience that men in a fight exaggerate their success.

⁵⁵ NAC, M.G. 30 E300 (Odlum Papers) Vol. 17, Folder: Orders and Summaries, November 1915 (2). "Examination of Prisoners Taken at Petite Douve," by Lt. Col. Mitchell, November 17, 1915.

piece battles requiring a well orchestrated plan.⁵⁶ The need for, and careful study of, information on German habits and defensive layouts was crucial for success, and for ensuring minimal losses to assaulting troops. Ground troops needed a full understanding of the German position, as they could not simply enter and wander about German trenches at will. Preparations for the November 1915 raid, for instance, began ten days earlier. Brigadier-General L.J. Lipsett, commander of the 2nd Brigade, wrote: "For success of such an operation it seems essential that the ground should [be] well scouted; that the men should know the ground and should thoroughly understand and frequently rehearse the part they have to play." This echoed the opinion of Lieutenant Colonel Victor Odium, commander of the 7th Battalion, when he reported that "The success of the enterprise was due to careful scouting, extending over weeks of time; and to careful preparation."⁵⁷ The Canadian Corps, writing in August 1916, agreed with the principle of extensive scouting, stating that "The first essential for successful raids is superiority in patrolling NO MAN'S LAND." Constant patrolling gave the men confidence working in front of the wire and accustomed them "to the 'feel' of the enemy, his

⁵⁶ A full scale set-piece attack was an elaborately constructed and closely timed attack that saw the infantry advance to pre-assigned objectives under cover of a violent and precisely timed rolling artillery barrage, and after or during a period of intense counter battery fire. Upon reaching their goals the infantry rapidly consolidated the captured terrain in order to meet the anticipated German counter attack.

⁵⁷ NAC, R.G. 9 III D3, Vol. 4826, 1st Division War Diary, November 1915, Appendix 17. "Canadian Corps Report on Enterprise at la Petite Douve by 2nd Canadian Infantry Brigade, November 17, 1915;" also "Report on Minor Operations," 7th Battalion. Similarly, a February 1916 memorandum produced by the 2nd Division declared the "Absolute necessity for thorough and perfect reconnaissance of every portion of ground to be covered in the approach, and the ground also on both sides of approach, up to point of entry in German Trenches." See R.G. 9 III C3, Vol. 4098, Folder 42, File 3. 2nd Division to Canadian Corps regarding "Deductions from Recent Minor Operations," February 3, 1916.

front line defences and his habits.”⁵⁸ Bold patrolling helped drive in enemy patrols, LPs, and others that might jeopardize the raid, and made the task of intelligence gathering easier. On at least one occasion prior to the November 1915 raid, Lieutenant H.H. Owen of the 7th Battalion (the officer who largely planned the 7th Battalion’s part in the raid⁵⁹), with a party of scouts, actually “climbed the enemy parapet” for a look inside. Consequently, as Odlum noted, 7th Battalion planners “knew every foot of ground from our own trench to the inside of the enemy trenches.” It was important for scouts to thoroughly know the terrain for it was their task to guide assaulting troops to their objectives during the raid. Meanwhile, all ranks studied the details of the plan and their part in it. They also familiarized themselves with the actual terrain they had to cross, and did so by either walking over it at night, or observing it from behind the lines during the day. Constant observation of the enemy was necessary, right up to the moment the raid was launched, in order to ensure that conditions had not changed. In this regard, scouts went out on the night of a raid to cut the German wire and to check that all was in order.⁶⁰

⁵⁸ NAC, M.G. 30 E61 (Mitchell Papers) Vol. 16, Folder: Western Front, Orders and Instructions, 1916 - 1918. “Trench Raids. Based Upon Raids Done by the Canadian Corps. A Lecture to Corps Officers’ School,” by Canadian Corps Intelligence, August 20, 1916. Earlier in the year the 2nd Division wrote: “One of the first steps necessary to success of such enterprises [raids, for example]...appears to be the necessity of establishing strongly and keeping up continuously, a distinct superiority in patrols in NO MAN’S LAND.” It added that dominating no man’s land reduced enemy morale. For example, due to Canadian aggressiveness, prisoners stated that no man amongst their units had volunteered for patrol work in over a month. See R.G. 9 III C3, Vol. 4098, Folder 42, File 3. 2nd Division to Canadian Corps regarding “Deductions from Recent Minor Operations,” February 3, 1916.

⁵⁹ T.V. Scudamore, *A Short History of the 7th Battalion, CEF* (Vancouver: Anderson and Odlum, 1930), 15.

⁶⁰ NAC, R.G. 9 III D3, Vol. 4826, 1st Division War Diary, November 1915, Appendix 17. “Report on Minor Operations” carried out by 7th Battalion. Owen did not lead the raid, that honour belonged to Lt. W.D. Holmes. See also R.G. 9 III C3, Vol. 4098, Folder 42, File 3. 2nd Division to Canadian Corps regarding “Deductions from Recent Minor Operations,” February 3, 1916.

The raiders also required pre-raid intelligence for selecting training grounds. The 7th Battalion commented on this in its report to the 1st Canadian Division after the November 1915 raid.

A field was found where the natural configuration lent itself easily to adaptation to resemble the enemy trenches; a ditch served for the DOUVE river; a path for the MESSINES road; another ditch for the enemy wire trench; and a succession of stakes for the PETITE DOUVE fort. Other trenches were turned to make the plan complete.⁶¹

The artillery supporting the raid required pre-raid intelligence too. Gunnery officers attended the infantry's planning sessions, for instance, in order to form joint plans. In an effort to deceive the enemy as to the real location of the raid, the artillery, in the hours leading up to the launch-time, shelled several different wire locations along the German front. The gunners also shelled and harassed the German front lines and communication trenches. Fire from trench mortars and machine guns added to the din of battle and, it was hoped, to German confusion.⁶²

While pre-raid intelligence did not guarantee a successful raid, lack of intelligence could greatly hinder an operation. A deficiency in intelligence led directly to the failure of the 5th Battalion to break into the German lines during the Douve River raid. Assaulting troops stumbled on to a previously undiscovered water-filled ditch that blocked their path. Rendering passage more hazardous was a wire entanglement placed at the bottom of the ditch. Crossing it was impossible, so the raiders had to content themselves with lobbing a few grenades into the German

⁶¹ NAC, R.G. 9 III D3, Vol. 4826, 1st Division War Diary, November 1915, Appendix 17. "Report on Minor Operations," 7th Battalion.

⁶² NAC, R.G. 9 III D3, Vol. 4826, 1st Division War Diary, November 1915, Appendix 17. "Canadian Corps Report on Enterprise at la Petite Douve by 2nd Canadian Infantry Brigade, November 17, 1915." Bill Rawling, *Surviving Trench Warfare, Technology and the Canadian Corps, 1914-1918* (Toronto: University of Toronto Press, 1992), 48.

trench and making a hasty retreat.⁶³

The next big Canadian raid after November 1915 occurred on the night of January 30-31, 1916, and is important from an intelligence point of view for a number of innovations adopted. Unlike the raid along the Douve River in November, the January raiders benefited from the study of airplane photographs taken specifically with the raid in mind. Captain D.E. Macintyre, the 28th Battalion's scout officer, used these photographs to draw an enlarged map of the area for planning purposes. The Canadians also constructed a model of the area to be raided, which the assaulting troops used to rehearse their roles. This was not the first time that the Canadians had built a model of the enemy position; during the summer of 1915, the Canadian Motor Machine Brigade had produced a plaster relief map of the front and discovered through a study of this model that the Germans could use indirect machine gun fire on the Canadian lines. The Canadians also learned that they could do the same to the Germans.⁶⁴ As for the January raid, Macintyre used the maps and photographs of the area as guides for laying out, in white tape,

an exact duplicate of that part of the enemy trenches we were to enter. This was on ground that somewhat resembled the actual ground to be covered. We practiced our approach carefully by day and then by night, crawling the exact distance to be covered.⁶⁵

One other innovation was the compilation of an intelligence file filled with information on the area to be raided. This was a project of Captain Harry Jukes,

⁶³ NAC, R.G. 9 III D1, Vol. 4676, Folder 3, File 7. Summary of Operations, Canadian Corps, November 15-22, 1915; R.G. 24, Vol. 1825, Folder GAQ 5-66. General Lipsett to "My dear General," November 20, 1915. Nicholson, *Official History*, 123-125.

⁶⁴ Larry Worthington, *Amid the Guns Below: The Story of the Canadian Corps (1914-1919)* (Toronto: McClelland & Stewart, 1965), 36.

⁶⁵ NAC, M.G. 30 E241 (Macintyre Papers) Vol. 1. Diary entry for January 30, 1916. This entry was actually written on February 3, 1916, and backdated.

the staff captain(I) for the 6th Brigade. The file was an information package given to all raiders for their study and use. It contained minutiae on how to conduct minor operations, a description of the enemy's trench, the ways and means of blocking a communication trench, notes on German equipment, methods for discovering the whereabouts of German machine guns, a description of German habits especially regarding sentries, a map of all known German machine gun posts, a description and historical summary of the German unit opposite, and notes on what to say if captured. Brigadier-General H.D.B. Ketchen, commander of the 6th Brigade, noted that "This file was of great assistance to all ranks and gave many hints which were experimented on." Similar files became a regular feature of future Canadian raid planning, and they expanded to include daily patrol reports, photographs, artillery observation reports, POW statements, and other intelligence bearing on the raid. Other changes worth mentioning from the November raid included the blackening of skin rather than the use of veils to hide faces, and the use of flashlights for searching enemy positions. The removal of all identifying papers and equipment that rattled and jingled was a necessary precaution, and to help suppress coughing the men used cough lozenges. Luminous watches were, of course, turned face down.⁶⁶

Raiding became a standard Canadian tactic for securing intelligence. Between November 1, 1916 and April 1, 1917, the Canadian Corps launched sixty. Forty-eight of these raids managed to enter the German trenches, and a total of 338 prisoners taken.⁶⁷ Some brigades ordered each battalion to conduct at least

⁶⁶ NAC, M.G. 30 E5 (Bovey Papers) Vol. 5, Folder 47. Report by Brigadier General Ketchen on the raid carried out on January 30-31, 1916, written February 3, 1916; M.G. 30 E300 (Odlum Papers) Vol. 24, Folder: Raids, February 1916 - June 1917.

⁶⁷ NAC, R.G. 24, Vol. 1826, Folder GAQ 5-89: Raids -- Canadian Corps. Summary of Raids, November 1, 1916 to April 1, 1917.

one raid per trench tour.⁶⁸ In December 1917, General Currie, then the corps commander, wanted “raids to be freely carried out” as a means to secure identifications of enemy troops. This was not an order for indiscriminate raiding though. Currie wanted each raid carefully planned, with useful and specific objectives and a reasonable chance of success.⁶⁹ Certainly raids often cost men their lives, but the intelligence gained was usually worth the effort, for as Nicholson says in his *Gunners of Canada*, the intelligence gathered saved many casualties on the day of advance. This was why in the nights leading up to the Canadian assault on Vimy Ridge in 1917, the Canadian Corps conducted nightly raids against the German line.⁷⁰

Figure 4.1, “The Trench Raid,” shows how raiders penetrated the enemy lines on their fact finding missions, and illustrates something of the role played by scouts and other raiders. The importance of communications is also evident from the diagram, as signallers accompanying raids established telephone connections between the raiders and their home trench for passing on information and news for command and control purposes -- an enormous undertaking considering that raiders remained in the enemy lines for only brief periods, up to a maximum of about forty-five minutes.⁷¹

By the end of 1915, the Canadians knew the value of combat intelligence first hand. By the time of the Givenchy fighting, they saw that launching attacks in ignorance of the opposing lines and the intervening terrain was folly. From then on

⁶⁸ NAC, M.G. 30 E300 (Odlum Papers) Vol. 24, Folder: Trench Discipline and Organization March 1916 - April 1918. 11th Brigade to Battalions, January 6, 1917.

⁶⁹ NAC, R.G. 9 III C3, Vol. 4063, Folder 14, File 3. December 7, 1917.

⁷⁰ G.W.L. Nicholson, *The Gunners of Canada. A History of the Royal Regiment of Canadian Artillery, Vol. 1, 1534 - 1919* (Toronto: McClelland & Stewart, 1967), 275; Nicholson, *Official History*, 251.

⁷¹ Most raids were over far faster than that. During the raid carried out on the night of January 30/31, 1916, for example, the men were instructed to get out after eight minutes.

Figure 4.1: The Trench Raid⁷²

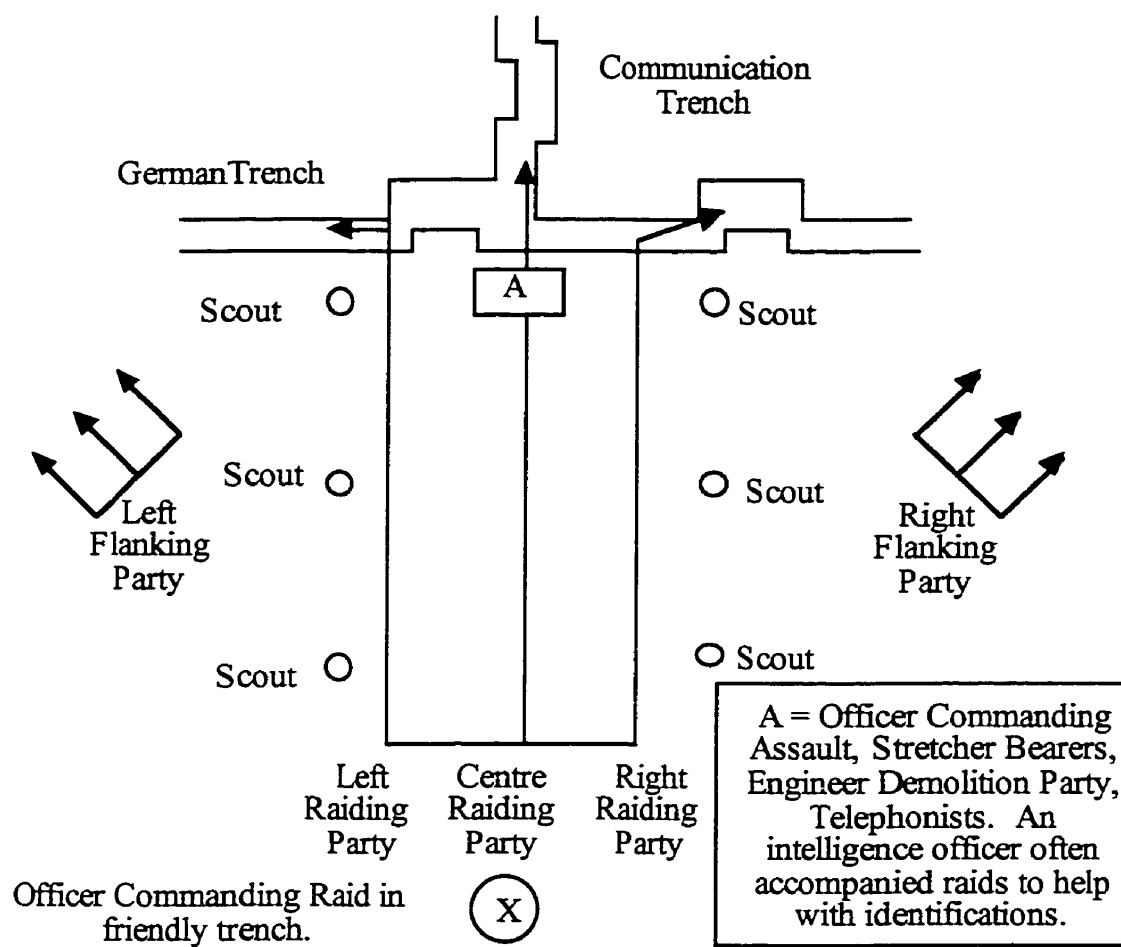

⁷² NAC, M.G. 30 E 300 (Odlum Papers) Vol. 24, Folder: Raids -- February 1916 - June 1917. Based on Odlum's diagram contained in a letter to senior officers on how to conduct a raid, February 10, 1916.

they set out to learn all they could about the ground and defences they had to attack or defend. The Canadians saw information as the key to planning, and Generals Turner's and Currie's desire to postpone assaults reflected this growing awareness. The need to know the strength, weakness and position of the enemy, while a seemingly obvious prerequisite to victory, had to be relearned for trench warfare. Canadian battle experience also showed that confusion and the loss of control were normal conditions facing commanders in a war where communications were unreliable. But as Givenchy also showed, prior planning could reduce such disorder, and return to commanders some semblance of control. Developing winning plans, however, required a great deal of information on the enemy position. It was only natural, then, that the raid emerged from the Canadians' newfound inquisitiveness and thirst for news. The tight scheduling and detailed battle arrangements necessary for successful raiding reinforced, in turn, the idea that confusion and luck could be reduced by thorough preparation. The amount of information such pre-calculation demanded, however, was far in excess of what the Canadians' limited intelligence organization could produce. A new organization was required.

CHAPTER FIVE

EMERGING PROFESSIONALISM: AUGUST 1915 - MAY 1916

The year 1915 was an important one in the development of the Canadian combat intelligence service. In September the Canadian Corps was formed when the 2nd Canadian Division arrived in France, doubling the size of the Canadian commitment. Battle experience also helped transform what were citizen soldiers and part-time militia officers into professionals -- a process described in Stephen Harris' *Canadian Brass*. Part of this professionalization was the growing appreciation for how battlefield intelligence and detailed planning reduced battlefield friction, confusion, chance and uncertainty. Calculating movements in advance took much of the guesswork out of operations. In the process, as the importance of intelligence to such planning became clear, the prestige of even the lowliest intelligence gatherer increased, while intelligence officers, once relatively unimportant, now made a positive impact on the course of events. Commanders and planners began placing great stock in the work of intelligence personnel, ultimately arriving at a point where the corps would not move forward until every possible scrap of intelligence was collected beforehand. But before the Canadians arrived at this point, they required a new intelligence organization.

The calls for change began in earnest in the summer of 1915. Canadian trench experience had revealed shortcomings in battalion level intelligence gathering. Patrols and observation work in particular were not as productive as they might have been. A corrective was offered by Lieutenant H.H. Owen of the 7th Canadian Battalion. Owen was an officer whose leadership ability was

recognized by no less a figure than General Currie. Early in July 1915, Owen called for the creation of battalion intelligence sections devoted to full-time intelligence gathering; and although he may not have been the first to do so, his letter to his battalion commander makes the case well. He wrote:

During our recent trench duty one was continually impressed by the unusually favourable conditions on our immediate front for the pursuance of patrol and information scouting, both offensive and defensive, and listening patrols etc. As you [the battalion commander] are fully aware the prevalent system of Company outpost work has not been a huge success; but on the contrary has resulted in a considerable amount of overlapping and uncertainty on the part of the Company Commanders, both as to the position of their neighbouring patrols and to the nature of the ground to be covered by their own scouts. Further the passing and repassing of warning orders down the line about patrols, orders which often run on for long distances beyond the points they could possibly affect, has led to a great deal of possibly unnecessary confusion and uncertainty: The Company Commanders owing to their already pressing duties are not at liberty to pay a great deal of attention to the choosing of scouting grounds, the collection of data secured and the improvement of listening posts and their safe guarding against accidents.

There are other minor points which are unnecessary to enumerate, but all of which I think would be helped to a marked extent if the Battalion outpost work were placed under the direct supervision of one officer, who with a picked section of scouts could carry on the work with a definite objective for all companies as well as actively cooperating with the Battalion snipers in their duties.¹

¹ National Archives of Canada (NAC), Manuscript Group (M.G.) 30 E300 (Odlum Papers) Vol. 16, Folder: Intelligence Summaries, Reports, Messages and Signals July 1915. Lieutenant H.H. Owen to the 7th Battalion commander, July 3, 1915. Owen was killed on January 30, 1916. In a letter dated December 1915, General Currie wrote to Owen's father (who was a chaplain in the 2nd Division): "Your son is one in whom I put great trust, and I look forward to his rapid promotion if he is spared. I could not say anything better, could I, and mean it." On January 31, 1916, the day after Owen's death, Currie again wrote to Owen's father: "His loss to us is irreparable," and noted that his battalion was second to none in reconnaissance work. "I can assure you," Currie went on to say, "that the influence of his many soldierly qualities will be lasting, not only in his Battalion but in this Division." These references can be found in a booklet in M.G. 30 E300 (Odlum Papers) Vol. 24. "In Memoriam. Lieutenant Harold Heber Owen." At the time Owen was killed his father was burying men who had died in a raid the night before. See D.E. Macintyre's *Canada at Vimy* (Toronto: Peter Martin Associates, Ltd., 1967), 31.

Clearly, in Owen's view, patrol work and front line intelligence gathering in general, left much to be desired, but with centralized control many of the failings could be corrected.

Others were drawing the same conclusion. In July the 2nd Canadian Division, then in training in England, decided to institute battalion scout sections in all of its battalions in response to lessons learned by the 1st Division.² The 1st Canadian Division instituted a similar reorganization over the next several months.³ However, it took time to make the necessary changes, so it was not until about May 1916 that all battalions in the corps had organized scout sections for handling battalion intelligence needs.⁴ Immediately upon appointing a battalion scout officer, the 14th Battalion's patrolling improved, as did its control of no man's land. The 13th Battalion witnessed a similar improvement; no doubt other Canadian battalions did likewise.⁵

These unofficial Scout sections had no fixed establishment; a turn of events that probably helps explain why some Canadian battalions were slow to adopt

² NAC, Record Group (R.G.) 9 III C3, Vol. 4143, Folder 8, File 8. "Organization and Training of Battalion Scouts. 2nd Canadian Division," n.d., likely July 1915.

³ British battalions did not institute battalion scout sections at this time. They did have them in place, however, by the time they fought the Somme battles in 1916. See Macintyre, *Canada At Vimy*, 11.

⁴ NAC, M.G. 30 E300 (Odlum Papers) Vol. 24, Folder: Trench Discipline and Organization March 1916 - April 1918. 2nd Canadian Brigade to Battalions, March 29, 1916; M.G. 30 E60 (Matthews Papers) Vol. 5, Folder 18. 8th Battalion to 2nd Brigade staff captain(I), April 11, 1916; R.G. 9 III C3, Vol. 4138, Folder 5, File 11. Staff Captain Jukes, 6th Brigade to 28th Battalion, January 4, 1916. The same document can be found in Vol. 4130, but is addressed to the 27th Battalion; Vol. 4140, Folder 10, File 13. Second Division to 6th Brigade, February 14, 1916. As late as March 6, 1916, the 2nd Brigade could ask its battalions if "any special organization for Snipers and Observers" had been organized, and if so what that organization was. Obviously at this point in the war battalions decided for themselves the make-up and complement of their intelligence sections, with little input from above. See R.G. 9 III C3, Vol. 4057, Folder 35, File 3. 2nd Brigade to battalions, March 6, 1916.

⁵ F.C. Fetherstonhaugh, *The Royal Montreal Regiment, 14th Battalion, C.E.F., 1914-1925* (Montreal: Privately printed, 1925), 73-74; Paul Hutchison, *Canada's Black Watch* (Montreal: The Black Watch of Canada, 1962), 78.

them. Even their nomenclature varied from command to command. In some battalions -- the 7th, for example -- scout officers were referred to as reconnaissance officers (at least early on).⁶ More often, scout officers were called intelligence officers, although the two designations were used interchangeably. The scout section was also referred to by various names: the intelligence section, the scout section or as the battalion scouts. Without a set establishment the size of scout sections also varied considerably from one battalion to another. Scout sections contained anywhere from sixteen to forty and more men plus scout officers, although in late 1915 the standard scout section had about sixteen scouts and two to four scout NCOs, all under a scout officer who was either a lieutenant or a captain.⁷ Even so, in May 1916, the 4th Brigade reported that the 18th Battalion had one scout officer and seven trained scouts available, the 19th Battalion had one officer and twenty-four scouts, the 20th Battalion had one officer and forty-one scouts, while the 21st Battalion had one officer and twenty-one trained scouts. Consequently, the 4th Brigade feared that its intelligence effort lacked "cohesion" and "maximum efficiency," and so asked that all battalions try to conform to a standard establishment within the brigade.⁸ The lack of a set establishment was a problem the 7th Battalion noted, too, as early as March 1916. At that time the commander of the battalion, wrote: "The greatest difficulty in operating this [intelligence] system arose for a long time from the divergent methods used by the

⁶ NAC, R.G. 9 III C3, Vol. 4057, Folder 35, File 3. 7th Battalion to 2nd Brigade, March 8, 1916.

⁷ NAC, M.G. 30 E100 (Currie Papers) Vol. 35, File 159. 25th Battalion "Supplementary Orders," October 27, 1915. This order called for sixteen NCOs and men to form the scout section. The 50th Battalion likewise called for sixteen men, four NCOs, one scout sergeant, and one officer commanding the section (see R.G. 9 III C3, Vol. 4217, Folder 7, File 9. "Appendix A, Battalion Scouts Organization," January 21, 1916).

⁸ NAC, R.G. 9 III C3, Vol. 4111, Folder 39, File 3. 4th Brigade to battalions, May 29, 1916. See also a note to 2nd Division from the 4th Brigade, dated May 27, 1916, located in the same file.

relieving battalion.”⁹ In August 1916, the 1st Canadian Division recommended its own establishment, saying that all battalions should have one scout officer, four scout NCOs, and sixteen scouts, for a total of twenty-one men.¹⁰ In January 1917, the corps informed its divisions that it hesitated to lay down a hard and fast establishment until such a time that the corps had gained more experience with battalion intelligence sections. The corps advised each division to adopt its own establishment as they saw fit, so as to have divisional uniformity.¹¹ It was not until early 1918 that the Canadian Corps settled on a corps-wide standard for battalion intelligence sections comprised of eight snipers, eight observers, eight scouts, one NCO, and two officers.¹² But with casualties and transfers, the size of battalion intelligence sections always varied from one unit to another.

Beginning in late 1915, battalions began incorporating snipers into their intelligence sections, a practice that soon became the norm. The 7th Battalion found that placing snipers under the scout officer increased their effectiveness and added to the intelligence efficiency of the unit. It also proved a corrective to what previously had “been desultory and aimless” sniper reports. The 6th Brigade agreed that by placing snipers in the scout section and having them “working under a

⁹ NAC, R.G. 9 III C3, Vol. 4057, Folder 35, File 3. 7th Battalion to 2nd Brigade, March 8, 1916.

¹⁰ NAC, M.G. 30 E61 (Mitchell Papers) Vol. 14, Folder: Intelligence Corps Instructions (2). “Instructions Regarding Intelligence. 1st Canadian Division,” August 5, 1916.

¹¹ NAC, R.G. 9 III C1, Vol. 3864, Folder 99, File 3. Corps to divisions, January 1917.

¹² See Chapter Eleven for further details on the 1918 reorganization. Until that time unit establishments varied. For example, at least one battalion, as late as January 1918, did not place scouts in its intelligence section. The 4th Battalion’s commander wrote: “I do not at all agree with scouts being included in the Battalion Intelligence Section as I have found that making the actual patrolling a Company matter, brings far better results. [It also] economizes in man power.” See R.G. 9 III C3, Vol. 4044, Folder 4, File 4. 4th Battalion to 1st Brigade, January 16, 1918. Also, Vol. 4224, Folder 6, File 13. 12th Brigade to 4th Division regarding the organization of brigade and battalion intelligence sections, January 17, 1918.

systematized plan” their efficiency improved. It soon came to be a scout officer responsibility to place snipers in the best available sniper posts, and oversee their training.¹³

Regardless of the number of scouts ultimately decided upon, they were always in addition to those employed by companies. The creation of battalion scout sections in no way relieved company commanders of their responsibility for safeguarding their front and gathering intelligence. The scout officer simply helped coordinate the intelligence effort. Companies continued to maintain up to four scouts of their own, plus a number of company snipers.¹⁴ In some cases the battalion and company scouts were rotated to preserve a uniform scouting proficiency across the board, “so that full co-operation and a nucleus of specially trained men could be built up.”¹⁵ This was not the normal practice, however, as the scout section required a cohesion and *esprit de corps* that was difficult to achieve if scouts were transient. It was not uncommon, though, for scout officers to utilize company scouts when required, or for company officers to ask for the assistance of battalion scouts for special tasks.¹⁶ Indeed, close cooperation between battalion scout officers and company commanders was vital for efficient patrolling and observation work. To this end, scout officers attended the daily company commander conferences in order to help set the day’s intelligence goals, to ensure that the front was properly attended to, and to see that effort was not wasted on

¹³ See NAC, M.G. 30 E300 (Odlum Papers) Vol. 24, Folder: Trench Discipline and Organization, March 1916 - April 1918. 7th Battalion to 2nd Brigade, March 8, 1916; and R.G. 9 III C3, Vol. 4138, Folder 5, File 11. Captain Jukes, staff captain(I), 6th Brigade to 28th Battalion, January 4, 1916.

¹⁴ NAC, M.G. 30 E239 (Hilliam Papers) Folder: Hilliam Papers: Field Messages 1915, 1917. Battalion commander to company commanders, October 8, 1915.

¹⁵ NAC, R.G. 9 III C3, Vol. 4138, Folder 5, File 11. Captain Jukes, staff captain(I), 6th Brigade to 28th Battalion, January 4, 1916.

¹⁶ NAC, M.G. 30 E239 (Hilliam Papers) Folder: Hilliam Papers: Field Messages 1915, 1917. Battalion commander to company commanders, October 8, 1915; M.G. 30 E300 (Odlum Papers) Vol. 24, Folder: Trench Discipline and Organization, March 1916 - April 1918. 2nd Brigade to Units, March 29, 1916.

redundant missions. Scout officers set the battalion's patrol policy, and saw to it that patrols had definite tasks to perform so that men did not just aimlessly wander about no man's land in search of some undefined information.¹⁷

The establishment of battalion scout sections was evidence that intelligence was now a specialized task, requiring specialized personnel. Only the best men were placed in scout sections, and were treated accordingly. In one 1916 lecture on the "Organization and System of Training Scouts and Patrols For Trench Warfare," the lecturer noted that "along with the Grenadiers," scouts are "the bravest men in the Battalion." They were struck off other duties such as work parties and parades, and "as far as possible" were relieved "from all Regimental Employ, such as Guards, Picquets, Fatigues, etc., etc." Assigning them extra duties only tired them out unnecessarily, reducing their "keenness and desire to excel."¹⁸ When they were not working in the lines they were training. Those individuals with low skill levels, or who displayed nervousness, returned to their companies as regular infantry or as company scouts.¹⁹ Scouts were encouraged by their officers to think of themselves as elite troops so that they would "go over the parapet when required to, with confidence and with a knowledge that they are trained scouts."²⁰

¹⁷ NAC, M.G. 30 E300 (Odlum Papers) Vol. 24, Folder: Trench Discipline and Organization, March 1916 - April 1918. 2nd Brigade to Units, March 29, 1916; M.G. 30 E50 (Jones Papers) Folder 3: Lectures: Canadian Corps Officers School. "Organization and System of Training Scouts and Patrols For Trench Warfare," 1916; R.G. 9 III C3, Vol. 4130, Folder 8, File 1. Captain Jukes to the 27th Battalion, January 4, 1916; R.G. 9 III C4, Vol. 4246, Folder 10, File 2. Canadian Corps to 2nd Division, December 15, 1916. In this document scout officers are also advised to work closely with FOOs and LOs to ensure maximum advantage was obtained from the supporting guns.

¹⁸ NAC, R.G. 9 III C3, Vol. 4143, Folder 8, File 8. Captain Jukes, staff captain(I), to 29th Battalion regarding the "Organization and Training of Scouts," August 3, 1915; M.G. 30 E50 (Jones Papers) Folder 3: Lectures: Canadian Corps Officers School. "Organization and System of Training Scouts and Patrols For Trench Warfare," 1916.

¹⁹ NAC, R.G. 9 III C3, Vol. 4041, Folder 17, File 8. An assessment of scouts and snipers in the 3rd Battalion, October 10, 1915.

²⁰ NAC, M.G. 30 E50 (Jones Papers) Folder 3: Lectures: Canadian Corps Officers School. "Organization and System of Training Scouts and Patrols For Trench Warfare," 1916.

Their elite status, and the vital nature of their work, was apparent in a number of lectures given by officers of the Canadian Corps in 1916. According to one lecturer: "Our own operations are largely dependent on intelligence," with every "small, trivial, scrap of intelligence" having the potential for "far reaching effect."²¹ Major J.L.R. Parsons, the GSO2(I) in the 2nd Division, noted that "[Brigades] and Divisions may move on what the Scouts tell them...When you [scouts] come back [from patrols] and tell us the situation ahead we shall either stay or go ahead according to the information you give us."²² Further, as one battalion commander pointed out: "It must be borne in mind that a Scout's duty is to gain information so that use can be made of it by the Troops for whom he is Scouting, and Not to fight when on Reconnoitring Expeditions."²³ This was a heavy responsibility, and one that demonstrates the value now attached to intelligence, and to the lowliest intelligence gatherer. Beginning in September 1916, to ensure that they were not mistaken for common 'other ranks,' scouts wore a special identifying badge.²⁴

The elite status accorded scout sections was partly attributable to the fact that the men in the unit were a picked lot. The commander of the 25th Battalion stated this principle clearly in October 1915, when he said that the battalion scout officer

will be allowed to choose his men...and if he wants more men from one Company than another, he can have them by applying through the C.O. He must have 16 N.C.O.'s and men for [intelligence] work, and he must always bear in mind that to get good scouting

²¹ NAC, M.G. 30 E61 (Mitchell Papers) Vol. 14, Folder 92. "Outline of Lectures on Intelligence," Canadian Corps, July 1916.

²² NAC, M.G. 30 E117 (Parsons Papers) Vol. 4, Folder 23. "Lecture by Major J.L.R. Parsons. General Staff, 2nd. Canadian Division," August 7, 1916.

²³ NAC, M.G. 30 E239 (Hilliam Papers) Folder: Field Messages 1915, 1917. Battalion commander, 5th Battalion, to company commanders, October 8, 1915.

²⁴ NAC, R.G. 9 III C4, Vol. 4334, Folder 7, File 5. 1st Canadian Division to the 1st, 2nd and 3rd Infantry Brigades, September 5, 1916. All specialists had distinguishing shoulder badges. The scouts' patch was worn one inch below the divisional patch and was shaped like a fancy arrowhead pointing upwards, and was about three and one half inches tall.

and reconnaissance, his men must be the very best obtainable. He may require an officer [to assist him] from time to time, and he may always have them.²⁵

The message was unmistakable; scouts were the best men in the outfit, and they were encouraged to think of themselves that way. One memorandum stated: "Too much emphasis cannot be placed on the necessity for careful selection of men for this important work, a work arduous as it is honourable and important."²⁶ Fearlessness, discretion, intelligence, craftiness and speed were the qualities of a good scout. And as one lecturer stated: "No man can be considered a trained scout until he has been proved under fire and in the face of the enemy."²⁷ In this vein, Lieutenant Colonel Odlum wrote that "Men who 'see things' are a curse instead of a blessing."²⁸ Parsons thought that "The man who smokes too much and drinks too much is not fit to be entrusted with the work of a Scout."²⁹ They had to be elite troops, for as the commander of the 5th Battalion noted: Scouts "must always remember they are the Eyes of the Force. Only Correct information given by them enables [commanding] officers to win Battles. Incorrect information causes disaster."³⁰ To maintain efficiency, officers constantly assessed the scouts, and in

²⁵ NAC, M.G. 30 E100 (Currie Papers) Vol. 35, File 159. 25th Battalion "Supplementary Orders," October 27, 1915; Similar references are found in M.G. 30 E117 (Parsons Papers) Vol. 4, Folder 23. "Lecture by Major J.L.R. Parsons, 2nd. Canadian Division," August 7, 1916; M.G. 30 E241 (Macintyre Papers) Vol. 1. Diary entry August 3, 1915.

²⁶ NAC, R.G. 9 III C3, Vol. 4217, Folder 7, File 9. "Appendix A: Battalion Scouts Organization," January 21, 1916.

²⁷ NAC, M.G. 30 E50 (Jones Papers) Folder 3: Lectures: Canadian Corps Officers School. "Organization and System of Training Scouts and Patrols For Trench Warfare," 1916.

²⁸ NAC, M.G. 30 E300 (Odlum Papers) Vol. 24, Folder: Trench Discipline and Organization, March 1916 - April 1918. 7th Battalion to 2nd Brigade, March 8, 1916.

²⁹ NAC, M.G. 30 E117 (Parsons Papers) Vol. 4, Folder 23. "Lecture by Major J.L.R. Parsons, 2nd. Canadian Division," August 7, 1916.

³⁰ NAC, M.G. 30 E239 (Hilliam Papers) Folder: Field Messages 1915, 1917. Battalion commander, 5th Battalion, to company commanders, October 8, 1915.

October 1915, “quite a few men” asked to be transferred back to their companies from the scout section, implying that scouting was no easy chore.³¹

The scouts’ specialized tasks included patrol work and making observations of the enemy’s front from OPs that they constructed under the direction of the scout officer. They worked in shifts around the clock -- during the day eight acted as observers, while at night eight worked on patrols. OPs were usually built behind the front lines, but positions in the forward trenches were not uncommon.³² Telescopes and field glasses were essential, although equipment shortages were common.³³ The 2nd Brigade informed its units that the scouts’ principal duties

will be to obtain an accurate knowledge of the enemy’s front line defences and the intervening ground, to obtain any information especially desired by the Battalion Commander, to assist or screen working parties as may be considered necessary, and to help on patrols to the complete domination of No Man’s Land.³⁴

Prior to an attack they ensured that the enemy’s wire was cut, while during a battle they carried out special reconnaissance missions, “and in other ways [were] immediately available for carrying out the wishes of the Brigade or Battalion Commanders.”³⁵ They helped guide troops to their objectives, sometimes acted as runners, liaised with neighbouring commands and assisted the signallers in their

³¹ NAC, R.G. 9 III C3, Vol. 4041, Folder 17, File 8. Assessing scouts in the 3rd Battalion, October 10, 1915.

³² NAC, M.G. 30 E300 (Odlum Papers) Vol. 24, Folder: Trench Discipline and Organization, March 1916 - April 1918. 2nd Brigade to Units, March 29, 1916

³³ NAC, R.G. 9 III C3, Vol. 4111, Folder 39, File 3. Officer commanding 21st Battalion to brigade major, 4th Brigade, May 31, 1916. In response: Staff captain, 4th Brigade to 21st Battalion, June 2, 1916. Even as late as January 1918, telescopes used by intelligence sections were borrowed from the signal service, making it extra difficult to find replacements. See R.G. 9 III C3, Vol. 4025, Folder 7, File 5. 1st Division to 1st Brigade, January 10, 1918.

³⁴ NAC, M.G. 30 E300 (Odlum Papers) Vol. 24, Folder: Trench Discipline and Organization, March 1916 - April 1918. 2nd Brigade to Units, March 29, 1916.

³⁵ NAC, M.G. 30 E50 (Jones Papers) Folder 3: Lectures: Canadian Corps Officers School. “Organization and System of Training Scouts and Patrols For Trench Warfare,” 1916.

efforts to maintain communications to the rear. Perhaps most importantly, scouts monitored the progress of assaults on behalf of battalion commanders, thereby restoring to those officers some, albeit limited, control over the battlefield through the information they sent back.³⁶ Once assaulting troops reached their objectives, scouts patrolled the front of the newly captured line to search for the enemy's latest location.

But even as attitudes shifted, and there was wide agreement that scouts were "to be treated in every way as specialists," there were still occasions in which the value of the scouting function seemed under-appreciated. In February 1916, the 2nd Canadian Division was disappointed that some battalions still frittered away their scouts. According to the division's calculations, sixty percent of all scout casualties occurred while scouts performed non-scouting duties. The division was adamant that this practice be stopped, as scouts "cannot be easily replaced."³⁷ The misunderstanding of the value of battalion scouts was also seen in the attitude of some company commanders who believed that the scout section stripped them of their best men.³⁸ However, as scout sections proved their value all objections were eventually overcome. The staff captain(I) of the 6th Brigade pointed out in August 1915 that "Officers Commanding Battalions will realize that men withdrawn from Companies to act as Scouts are not lost to the Company as they go to make up the general efficiency of the Unit as a whole."³⁹

Brigade intelligence underwent its own metamorphosis during the later part of 1915 and into early 1916. The enormous intelligence demands generated by

³⁶ NAC, R.G. 9 III C3, Vol. 4111, Folder 39, File 3. "Report on the Organization and Duties of the Scout Section Employed by the 20th Canadian Infantry Battalion," May 23, 1916.

³⁷ NAC, R.G. 9 III C3, Vol. 4140, Folder 10, File 13. Second Division to 6th Brigade, February 14, 1916.

³⁸ NAC, R.G. 9 III C3, Vol. 4111, Folder 39, File 3. 21st Battalion to 4th Brigade, May 31, 1916.

³⁹ NAC, R.G. 9 III C3, Vol. 4143, Folder 8, File 8. Captain Jukes, staff captain(I), 6th Brigade to 29th Battalion, August 3, 1915.

trench warfare, and the obvious need for better intelligence at the brigade level of command, rescued the intelligence role of brigade staff captains(I) from obscurity. By early 1916, their ill-defined role was completely reversed. They now had their own scouts to command, and had become for all intents and purposes, full-time intelligence officers.⁴⁰ Typically, staff captains(I) supervised brigade intelligence sections composed of four scout NCOs and between eight to twelve scouts.⁴¹ These men were seconded to brigades by subordinate battalions, usually two men and one NCO from each battalion. Occasionally battalion officers objected to parting with well trained scouts; but as one brigade major noted: “the success of a battalion may at some time depend upon the accuracy of observation of Brigade Observers,” and so battalions did not really lose the service of these men.⁴² The creation of brigade intelligence sections under staff captains(I) restored to brigade commanders some control over the battlefield, as brigade commanders now had their own independent source of information. This was important during battles, as brigadiers no longer had to wait for word of conditions at the front from others who were beyond their immediate control. Staff captains(I), with their teams of scouts,

⁴⁰ A.W. Currie, “Historical Resume of Canadian Corps Intelligence,” in J.E. Hahn *The Intelligence Service Within the Canadian Corps, 1914 - 1918* (Toronto: The Macmillan Company of Canada, Limited, 1930), xviii. Also Appendix VI: “Organization of Divisional Staff,” found in the *Report of the Ministry. Overseas Military Forces of Canada, 1918* (London, 1919), 291, interestingly shows brigade staff captains(I) reporting solely to the brigade major by the war’s end, and not the senior staff captain.

⁴¹ It was found that eight observers were sufficient to man two brigade OPs. The four extra scouts, in addition to easing the duties of brigade observers, acted as a battalion reserve for those battalions suffering severe scout casualties. The extra men ensured that observation did not stop. See Hahn, *The Intelligence Service*, 89 -90. British brigades adopted a similar organization. Anthony Clayton, in his book *Forearmed: A History of the Intelligence Corps* (London: Brassey’s (UK) Ltd., 1993), 30, says that they started doing so in 1917. However, the British were using brigade observers at least as early as August 1916. See R.G. 9 III C3, Vol. 4043, Folder 2, File 6. “Notes on Intelligence in the Somme Operations,” by Lieutenant Colonel Mitchell, August 16, 1916.

⁴² NAC, R.G. 9 III C3, Vol. 4039, Folder 10, File 11. Brigade major, 1st Brigade to the 3rd Battalion, August 20, 1916.

monitored actions and fed a continuous stream of up-to-date information to commanders throughout. Brigade intelligence sections also amassed a tremendous amount of information before assaults for their own and other command usage. Thanks to brigade intelligence sections, brigade commanders had their sight partially returned, a faculty lost to them with the advent of trench warfare when officers were forced to live underground or far from the front.

Intelligence responsibilities demanded that staff captains(I) be in close and regular contact with battalion scout officers whose efforts they directed. This allowed them to keep abreast of the front line situation, and to learn the capabilities of their brigades' various scout officers. Not being strangers to the front, staff captains(I) helped battalion scout officers position and equip observation posts, and made personal reconnaissances of the front. Moreover, they advised battalions on what special information higher command sought, supervised the updating of brigade maps, and took an active part in the training of battalion intelligence officers, scouts, snipers and observers. They attended planning sessions to learn the intelligence needs of brigade planners, and were consequently fully aware of brigade intentions -- a far cry from Second Ypres. At the same time, they kept divisional intelligence informed of intelligence developments in the brigade area through reports and personal contact. Maintaining touch with artillery OEs, FOOs, and neighbouring staff captains (with whom they compared methods and notes) also formed part of their duty. Staff captains(I) organized and implemented their brigades' observation work and arranged the layout of the OPs (sometimes referred to as intelligence posts to distinguish them from the artillery's OPs), and helped select targets for the artillery. Finally, they compiled daily brigade Intelligence

Summaries.⁴³ In short, staff captains(I) ensured that all the information required, be it on no man's land, or the enemy's wire, new work, habits, defences and rear areas was actually collected by front line units, and in a timely and effective manner.

The scouts the staff captains(I) commanded did not go on patrols or perform fatigue duties. Instead, they were used primarily "for distant observation" both prior to and during an advance, and "for such other special duties as may be assigned to them by the Brigadier." "[T]he special task of Brigade Observers," as defined by the 2nd Division, was "to observe enemy movements and works in rear of the German front line parapet, and as they are located on the most commanding ground available and provided with the necessary instruments, they should specialize in this particular duty, since this field is not open to the rest of the Infantry."⁴⁴ Brigade scouts built their own observation posts on commanding terrain behind the front lines. And because brigade OPs were stationary, semi-permanent and possessed a clear view of the front, they were the principal tactical intelligence OPs in the Canadian Corps.⁴⁵ During the final year of the war, two German speaking brigade observers, trained by divisional intelligence officers, helped process POWs captured by the division.⁴⁶

⁴³ NAC, M.G. 30 E300 (Odlum Papers) Vol. 24, Folder: Trench Discipline and Organization, March 1916 - April 1918. "Organization and Duties of Brigade and Battalion Scouts, 1st Canadian Division," 2nd Brigade to Units, March 29, 1916; M.G. 30 E241 (Macintyre Papers) Vol. 1. Diary entry March 9, 1916. Patrol reports often accompanied battalion and brigade Intelligence Summaries.

⁴⁴ NAC, R.G. 9 III C3, Vol. 4105, Folder 19, File 3. Second Canadian Division to Brigades, May 19, 1916.

⁴⁵ NAC, M.G. 30 E61 (Mitchell Papers) Vol. 14, Folder 92. "Outlines of Lectures on Intelligence," Canadian Corps, July 1916; M.G. 30 E300 (Odlum Papers) Vol. 24, Folder: Trench Discipline and Organization, March 1916 - April 1918. "Organization and Duties of Brigade and Battalion Scouts, 1st Canadian Division," 2nd Brigade to Units, March 29, 1916. Divisional OPs were not the principal OPs because divisions did not maintain permanent posts.

⁴⁶ Hahn, *The Intelligence Service*, 91 - 92. These brigade scouts did not carry out an intensive examination, but were limited in their work to extracting information of immediate tactical concern. Also, R.G. 9 III C3, Vol. 4224, Folder 6, File 13. 4th Division to subordinates, January 22, 1918.

Further evidence that brigade level intelligence, and intelligence in general, had matured and improved in the eyes of commanders was the 2nd Division's November 1915 decision to institute a policy whereby brigade observers, on a monthly basis, submitted a report that presented their opinions on what they saw. Normally, of course, observers submitted daily observation reports without interpretation. However, as the 2nd Division noted:

It is probable that [brigade] observers have certain ideas in connection with the movements, works and habits of the enemy...which they have not been able to support definitely by sufficient evidence but which may be of interest and importance, should the opinions of several observers in different parts of the Divisional front point toward the same conclusion.

It is hoped that as [much] scope as possible will be allowed the observers in these particular reports.⁴⁷

This was an acknowledgment by officers that observers (normally NCOs and other ranks) living near and observing the front day after day came to understand the Germans in ways that rear echelon personnel and decision makers -- not accustomed to dealing with the enemy in such a continuous and intimate way -- could not. With these reports the prestige of even the meanest intelligence gatherer had grown.

Divisional intelligence, too, was not unaffected when the Canadian Corps rearranged its intelligence organization during the second half of 1915. Intelligence work now carried sufficient weight that the senior divisional intelligence position in a Canadian division was raised from GSO3 to GSO2. The corps explained the need for the increased stature in a note to the 4th Division in 1917. The senior

⁴⁷ NAC, R.G. 9 III C3, Vol. 4135, Folder 22, File 4. Staff Captain Jukes, 6th Brigade to 27th Battalion, November 23, 1915; Vol. 4105, Folder 19, File 3. Second Division to 4th Brigade, February 27, 1916. See also Vol. 4088, Folder 16, File 2. "Notes on Daily Intelligence Reports," October 25, 1915. Opinions of observers are requested.

intelligence officer in a division, the corps stated, "must be sufficiently senior and sufficiently experienced to ensure that commanders of various units will place reliance on his deductions and suggestions." Broadly speaking, the GSO2(I) at division devised and implemented the division's intelligence policy. This included overseeing the preparation of the division's daily Intelligence Summary, and ensuring that observation posts throughout the division were properly coordinated so as to ensure maximum coverage of the enemy lines. Moreover, he was "to collect and distribute all information regarding the enemy's dispositions and defences opposite his Division...and...ensure that such information is brought to the attention of the arm which can make the most use of it." The GSO2(I) was also responsible for liaison between the infantry and its supporting arms down to battalions. "[T]he guiding principle throughout being that the Infantry through the General Staff are to state the work they require done, the method by which the task is to be completed being left to the supporting arms (Artillery, Trench Mortars, Machine Guns)." He readied all reports and maps concerning both friendly and enemy defences and wire entanglements, and was to "have a thorough knowledge of both our own and the enemy's tactics," while being fully cognizant of the capabilities and limitations of all supporting arms.⁴⁸

Assisting the GSO2(I) was a divisional GSO3(I). His tasks included preparing the daily divisional Intelligence Summary, seeing that log books, maps and photographs were studied and kept up to date, and generally supporting the

⁴⁸ NAC, R.G. 9 III C3, Vol. 4224, Folder 6, File 13. Canadian Corps to 4th Division, December 26, 1917. British divisions continued with the GSO3 as the senior divisional intelligence officer, and then only on a part-time basis; R.G. 9 III C3, Vol. 4104, Folder 16, File 3. "Lecture on Intelligence," by Brigadier-General J. Charteris, to Second Staff College Course at GHQ, February 4, 1916; M.G. 30 E60 (Mitchell Papers) Vol. 14, Folder 92. "Instructions Regarding Intelligence Duties, 2nd Army," October 1915, has more discussion on intelligence in British formations.

GSO2(I).⁴⁹ He, too, had to be fully conversant with Allied and enemy tactics, and be able to recognize changes in enemy habits. Further, the GSO3(I) met daily with various brigade, battalion, and artillery personnel so as to better understand their needs, capabilities and limitations, and to foster a closer working relationship amongst all parties. He checked that the various OPs dotting the divisional front were properly situated to give maximum coverage, and that they were adequately supplied. His presence was an enormous help to the division's senior intelligence officer, who until the reorganization was on his own. A number of clerks were also on hand by war's end: three draftsmen, one air photo clerk, and two other clerks.⁵⁰

Unlike brigades and battalions, divisions did not develop their own divisional intelligence sections for scouting and observation purposes. There were occasions, though, when divisional commanders did control temporary observers manning temporary divisional OPs. In the summer of 1915, for example, the 1st Canadian Division used temporary divisional observers to watch specific areas of front for specific purposes. Once the job was complete, the divisional observation post was disbanded.⁵¹ Similar arrangements were made by divisions throughout the war where the terrain warranted.⁵² In addition, divisional commanders had the

⁴⁹ NAC, M.G. 30 E60 (Matthews Papers) Vol. 7, Folder 25: Miscellaneous 1914 - 1919. "General Staff -- 1st Canadian Division," no date. For a description of log books see page 159.

⁵⁰ Hahn, *The Intelligence Service*, 114; S.R. Elliot, *Scarlet to Green. A History of Intelligence in the Canadian Army 1903 - 1963* (Toronto: Canadian Intelligence and Security Association, 1981), 22.

⁵¹ NAC, R.G. 9 III D3, Vol. 4825. Appendix 19 in the 1st Division's War Diary, July 1915.

⁵² In April 1918, there was talk of forming permanent divisional observation sections consisting of one NCO and twelve men under the divisional intelligence officer. See NAC, R.G. 9 III C3, Vol. 4025, Folder 7, File 4. 1 Division to Brigades, April 10, 1918. I could not find any evidence to show that the Canadians ever adopted this idea. In fact, their July 1918 "Intelligence Instructions Canadian Corps" -- a publication outlining corps intelligence policy -- is silent on the issue. Likewise, divisional observation sections are not mentioned in Hahn's, *The Intelligence Service*. However, GHQ's November 1918 edition of S.S. 135, "The

use of staff officers, and could reconnoitre the line for themselves should they desire a more direct view. However, the bulk of their news came from others whom they did not immediately control. Divisions, in other words, acted more as intelligence clearing houses, rearranging and compiling information for themselves and others, than as generators of raw data.

With the creation of the Canadian Corps in September 1915, planning increased in complexity as a whole new level of command was added to the Canadian Expeditionary Force's structure. The addition of a corps headquarters also added another layer to the Canadian combat intelligence effort. At the time of its formation the corps was subordinated to the British 2nd Army, and so received its initial instruction on corps level intelligence duties from that British command. In August, the 2nd Army released its "Notes on Intelligence Duties -- 2nd Army" (Intelligence Notes), outlining the intelligence policy to be followed by those under its command. The Canadian Corps received a copy of these instructions, thus gaining a ready made intelligence policy. The "Intelligence Notes" placed corps level intelligence firmly into the larger context of British combat intelligence by defining corps intelligence responsibilities. The "Intelligence Notes" stated:

The general principle of intelligence work is that Corps are responsible only for the collection of intelligence while the Army is responsible for collation. The essential is that all information collected by Corps should reach Army Headquarters as quickly as possible. No time, therefore, should be wasted at Corps Headquarters in attempting to piece information together, but, on the other hand, before forwarding intelligence to Army Headquarters, Corps must satisfy themselves that the information is reliable and not merely a report forwarded by some inexperienced observer. It is

Division in the Attack," states: "A divisional observation section plays a very important part during an action . . .", suggesting that at least some British divisions utilized divisional intelligence sections. The "Report on Communications 4th Canadian Division 26-9-18 to 2-10-18," mentions a divisional OP, but does not say if it was manned by a divisional intelligence section. See R.G. 9 III B1, Vol. 2279, Folder: 0-2-30 (Vol. 23). It is probable that some British divisions used intelligence sections and Canadian divisions did not; after all, intelligence systems were not set in stone.

for this purpose, amongst others, that Officers of the Intelligence Corps are attached to Corps Headquarters.⁵³

An updated version of "Intelligence Notes" entitled "Instructions Regarding Intelligence Duties, 2nd Army," issued in October added: "Corps...will, however, collate as well as collect certain information regarding the area in their immediate front," meaning each corps, including the Canadian Corps, in addition to keeping army command informed, was responsible for gathering and interpreting tactical intelligence of concern to itself.⁵⁴

Part of the corps' accumulation of tactical detail came from prisoner interrogations. The examination of prisoners (POWs) was an extremely important task, as prisoners were one of the chief sources of tactical information for troops in physical contact with the enemy.⁵⁵ Prisoners often revealed the timing of impending attacks and reliefs, helped to confirm suspected target locations, were a good gauge as to the effectiveness of Allied shelling and tactical methods, and helped planners better understand German habits and intentions. Lower level commands did not waste time questioning prisoners themselves, but sent them back to corps holding cages where experts dealt with them. The only exception was in asking questions of immediate tactical concern. As time passed, divisions took on greater interrogative responsibilities to ease the burden facing corps intelligence officers. Army instructions, however, made it clear that corps were not to assign

⁵³ NAC, M.G. 30 E61 (Mitchell Papers) Vol. 14, Folder 91. "Notes on Intelligence Duties -- 2nd Army," August 1915.

⁵⁴ NAC, M.G. 30 E61 (Mitchell Papers) Vol. 14, Folder 92. "Instructions Regarding Intelligence Duties, 2nd Army," October 1915; R.G. 9 III C3, Vol. 4104, Folder 16, File 3. "Lecture on Intelligence," by Brigadier General J. Charteris, to Second Staff College Course at GHQ, February 4, 1916. Charteris stated much the same thing in his lecture: "With the exception only of such information as immediately concerns the Corps front, Corps are responsible only for the collection of information, the collation is done by the Army."

⁵⁵ John Charteris, *At G.H.Q.* (London: Cassell and Company, Ltd., 1931), 159. July 29, 1916.

larger operational and strategic meaning to information and unit identifications gathered from POWs. This remained an army preserve.

There was an art to interrogating prisoners. To be most effective, examiners had to appreciate human psychology and use it to their advantage. In order to catch false statements, examiners had to appreciate German tactics, uniforms, army organization, and defensive layouts. Intelligence officers separated captured officers from the enlisted men, since the presence of officers tended to shore-up the courage of the other ranks, making it more difficult to extract information. For best results, interrogations occurred soon after capture, thus playing on the fears, sense of isolation, and shock experienced by POWs. To begin the interrogation intelligence officers endeavoured to relax and disarm the prisoners through seemingly meaningless chatter and friendship. Prisoners were asked about their families, where they were from, and were offered a cigarette. Many easy questions were asked. These were designed to build up an easygoing dialogue and some sense of trust. It was also important to start the POWs talking. The German Army's own propaganda, no doubt, helped interrogators here to a degree, as German soldiers were told that the Allies mistreated their prisoners. Not wanting to be handled roughly, POWs were bound to speak out. Indeed, the British sometimes threatened uncooperative prisoners by telling them that they would be handed over to the French Army for further interrogation if they did not start to open up -- the French, whether true or not, had a reputation for being unforgiving towards German captives.⁵⁶ Once POWs started talking and telling the truth, lying became more difficult. So as not to alarm prisoners and discourage conversation, the examiners took no notes during the interrogation. When time did not allow for the personal interrogation of all prisoners, or when prisoners were particularly

⁵⁶ Ferdinand Tuohy, *The Crater of Mars*, (London: William Heinemann Ltd., 1929), 96-97.

uncooperative, an intelligence officer, speaking impeccable German and disguised as a POW, sometimes went in amongst the captured men to listen and to strike up conversations with the intent of drawing out intelligence unbeknownst to the real POWs. Mistreating POWs to extract information was not Canadian or British policy, and does not appear to have been wide-spread, if practiced at all.⁵⁷

Canadian and British commands prized captured German documents almost as much as POWs for their intelligence potential. According to the 2nd British Army,

Experience has proved that intelligence derived from documents is second only in value to that derived from the actual examination of prisoners. Too much stress cannot be laid on the importance of the rapid and systematic examination of every single document captured.⁵⁸

Maps and sketches were particularly valued, but so too were official documents, diaries, and letters. Any papers that discussed troop movements, unit addresses and identifications, and German home-front economic conditions were sought. Maps often showed such tactical details as the location of machine gun posts, unit boundaries, and artillery emplacements. Diaries provided some understanding of troop morale. Official documents discussed wide ranging topics of obvious value to the Allies, including: lessons learned from recent fighting, signal and communication policy, new tactics and defensive policies, camouflage techniques,

⁵⁷ NAC, M.G. 30 E61 (Mitchell Papers) Vol. 14, Folder 92. "Instructions Regarding Intelligence Duties, 2nd Army," October 1915; Vol. 16, Folder: Western Front, Orders and Instructions. "Instructions for 2nd Corps Intelligence Officers in Examining Prisoners;" Christopher Andrew, *Secret Service: The Making of the British Intelligence Community* (London: Sphere Books, 1984), 296; Private Fraser, *The Journal of Private Fraser, Canadian Expeditionary Force*, ed. R.H. Roy (Victoria, B.C.: Sono Nis Press, 1985), 184, 188; Ferdinand Tuohy, *The Secret Corps. A Tale of Intelligence On All Fronts* (London: Murray, 1920), 254, 255, 258.

⁵⁸ NAC, M.G. 30 E61 (Mitchell Papers) Vol. 14, Folder 92. "Instructions for Intelligence Duties, 2nd Army," March 1916.

artillery instructions, casualties, and the Germans' own understanding of British methods.⁵⁹

In addition to examining POWs and documents, the Canadian Corps carried out some aerial reconnaissance responsibilities. To do this the corps had a Royal Flying Corps (RFC) squadron attached to its headquarters. Intelligence officers at corps headquarters worked closely with the squadron, arranging daily intelligence gathering missions. Aerial observers reported their findings at the end of each flight, unless they discovered something urgent, or were artillery spotting on behalf of friendly gunners. On those occasions they used wireless transmission, dropped messages at prearranged drop zones, or used some other signal. They could also land the plane and contact the appropriate command using some ground level means. Until March 1916, aerial photography remained an army concern. After March, when aerial resources were more plentiful and the need for local, tactical detail for planning purposes fully understood, corps squadrons began photographing German front line positions. Army command, however, did not relinquish its larger strategic interpretive powers, arrogating to itself the task of determining broader German intentions. At army headquarters "The results of all air reconnaissances [were] carefully compared so that anything abnormal [was] at once noticed."⁶⁰ Conclusions were then transmitted to the appropriate corps.

As with divisions, corps headquarters did not develop scout sections to carry out corps level scouting and observation work. It was not until the later stages of 1917, after the Canadian Corps began utilizing corps observers, that corps

⁵⁹ NAC, R.G. 9 III C3, Vol. 4088. Folder 16, File 2. Translated German document, September 12, 1916; Hahn, *The Intelligence Service*, 52 - 53.

⁶⁰ NAC, M.G. 30 E61 (Mitchell Papers) Vol. 14, Folder 92. "Instructions Regarding Intelligence Duties, 2nd Army," October 1915; and Amendments to "Instructions Regarding Intelligence Duties, 2nd Army," November 1915; and "Instructions for Intelligence Duties, 2nd Army," March 1916; Vol. 16, Folder: Western Front: Orders and Instructions, 1914 - 1915. "Notes on Intelligence Duties -- 2nd Army," August 1915.

headquarters acquired its own full-time, independent, ground-level intelligence gathering force. This gave corps headquarters more local and immediate insight into unfolding situations, which allowed it to better adjust reserve movements and artillery plans.⁶¹ Until that time it was dependent upon the observation of others.

As a corps, the Canadians also had some responsibility for counter-espionage work, although the bulk of this was handled by GHQ and army command. Corps level counter-espionage normally encompassed the apprehension of enemy agents and other suspicious characters operating in the corps area. Corps intelligence officers cooperated with local Belgian and French security services, with the provost marshal's branch, GHQ intelligence, and the army intelligence police stationed in each corps sector.⁶² The fear that enemy operatives were working in and behind Allied lines was widespread during the war, and troops were to suspect all unknown personages, and be alert to civilians signalling the German lines. Officers warned their men that seemingly normal activities might in fact be efforts to aid the enemy. During the more hysterical period early in the war, some saw the arrangement of differently coloured sheets hung on clothes-lines as cause for concern. Smoke signals and carrier pigeons let loose from behind the lines were also watched for. The historian of the 2nd Canadian Battalion recorded:

If the peasant ran his ploughs through his fields and made furrows that were not to the liking of the soldiery, they immediately marked him as conveying information to German aeroplanes. Let him put a white horse into a field in which there was already one or two brown, and he was giving away secrets of Canadian artillery locations. It was quite a pastime, sleuthing spies.⁶³

⁶¹ See the discussion on the Canadian Corps Survey Section beginning on page 341.

⁶² NAC, M.G. 30 E61 (Mitchell Papers) Vol. 16, Folder: Western Front: Orders and Instructions, 1914 - 1915. "Notes on Intelligence Duties -- Second Army," August 1915.

⁶³ W.W. Murray, *The History of the 2nd Canadian Battalion (Eastern Ontario Regiment) Canadian Expeditionary Force in the Great War* (Ottawa: Mortimer Ltd., 1947), 70.

In September 1916, the Canadians actually investigated reports that windmills were being used to signal the German lines. On one occasion the commander of the 38th Canadian Battalion informed the 12th Brigade headquarters that

I made a further investigation into this matter and find that a number of men have noticed at various times a seemingly irregularity in the movement of this windmill. At times the one leaf of the windmill is directly upwards, and the next time two of the fans form a 'V', and these two movements follow one another. It has also been noticed that it goes in opposite directions at times to the other mills. Whether there is anything in this or not it is very hard to say.⁶⁴

GHQ warned all ranks that Germans dressed in Allied uniforms sometimes infiltrated friendly lines with the intention of amassing insights into Allied plans by striking up conversations with unsuspecting soldiers.⁶⁵

Mention has been made of intelligence police. This body, formed in October 1915 at army level command, had detachments stationed in each corps area.⁶⁶ In September 1915, the British asked the Canadian Corps to supply the names of three men who might prove suitable to the intelligence police force. They had to be fluent in French, and possess a good, energetic and reliable character. They needed trench experience and at least three months service in France. Men with experience in the Royal North West Mounted Police, in the secret service, or as detectives were preferred.⁶⁷ Intelligence police prevented unauthorized personnel

⁶⁴ NAC, R.G. 9 III C3, Vol. 4224, Folder 6, File 12. 38th Battalion to 12th Brigade, September 15, 1916. A similar story is recounted in Murray, *2nd Battalion*, 70.

⁶⁵ NAC, M.G. 30 E61 (Mitchell Papers) Vol. 16, Folder: Western Front: Orders and Instructions 1914 - 15. "Notes From the Front, Part III and Further Notes on Field Defenses," by GHQ, February 1915.

⁶⁶ NAC, M.G. 30 E61 (Mitchell Papers) Vol. 14, Folder 92. "Notes on the Scope and Distribution of I(b) Work in an Army," issued by Advanced GHQ, September 5, 1916.

⁶⁷ NAC, R.G. 9 III C3, Vol. 4039, Folder 10, File 11. 1st Brigade to 3rd Battalion, September 7, 1915.

from wandering about restricted areas and gaining access to various headquarters units. They aided corps intelligence officers in their counter-espionage work, such as investigating reports of information leakage by friendly troops and enemy agents, and helped escort prisoners, carefully listening to conversations in the process. Other duties included spreading rumours for the purpose of misleading both friendly and enemy troops, tracking enemy movements during enemy retreats, and securing towns upon their capture.⁶⁸

Overseeing corps intelligence was a general staff officer, second grade, the GSO2(I). He was a full-time intelligence officer, which was a different practice from the British. In British corps -- at least early on -- the senior intelligence position was part-time, although the 2nd Army counselled that "This officer, while available for other duties should be employed primarily on intelligence duties." The Second Army further advised that "If this is not an established practice during the period when no important operations are in progress, in times of strain the collection of intelligence will suffer."⁶⁹ The Canadian Corps' first GSO2(I) was Lieutenant Colonel C.H. Mitchell. This was the same man who had headed intelligence in the 1st Canadian Division prior to his posting to the corps as its senior intelligence officer. Mitchell was, according to his own estimation, responsible for gathering together all the information on German positions in the corps' sector and forwarding it to both army headquarters and lower level commands after having first arranged it into usable form. He was accountable for the preparation of the corps' daily Intelligence Summary, the examination of prisoners and captured documents, for conducting secret agent work in the corps area, and for gathering together information on the enemy's shells, shoulder straps

⁶⁸ NAC, M.G. 30 E61 (Mitchell Papers) Vol. 14, Folder 92. "Instructions Regarding Intelligence Duties, 2nd Army," October 1915; R.G. 9 III C3, Vol. 4104, Folder 16, File 3. "Contre-Espionage," 2nd Army, [1916].

⁶⁹ NAC, M.G. 30 E61 (Mitchell Papers) Vol. 16, Folder: Western Front, Orders and Instructions, 1914 - 1915. Second Army to Corps, September 29, 1915.

and uniforms in order to make and confirm identifications. He oversaw the construction of maps and tracings required throughout the corps, the study and filing of aerial reconnaissance reports, and censorship. He also administered the corps' Intelligence Fund. Furthermore, he ensured that the necessary topographical information of the surrounding countryside was obtained and collated, and that the RFC squadron attached to the corps knew the corps' aerial reconnaissance needs. He had, too, to be intimately familiar with all that was going on at headquarters and along the Canadian front, and be fully versed in operational planning so that the required intelligence was gathered and effectively utilized. Once the ever anticipated open warfare season resumed he had to be fully aware of the enemy's whereabouts and movements, and ensure that proper liaison was maintained with subordinate divisions, neighbouring corps, and higher commands.⁷⁰ In effect, he was responsible for implementing and controlling the corps' intelligence needs and policies.

There were a number of individuals assisting Mitchell. For one, the GSO2(operations) worked closely with him to ensure that both intelligence and operational planning were in sync. A corps-level staff captain(I) also assisted him, and did so in much the same way that the GSO3(I) at division helped the divisional GSO2(I). Along with the staff captain(I) there were two officers from the British Intelligence Corps attached to corps headquarters. They were experts in the French and German languages, and had undergone special training in German military

⁷⁰ NAC, M.G. 30 E61 (Mitchell Papers) Vol. 16, Folder: Western Front: Orders and Instructions, 1914 - 1915. From a summary of duties Mitchell prepared, September 18, 1915; Vol. 14, Folder 92. "Instructions for Intelligence Duties, 2nd Army," March 1916. Money for the corps' secret service fund was provided by the Army upon application. Unfortunately the records are silent on exactly what the secret service fund was all about.

organization and other military matters.⁷¹ They worked directly for the GSO2(I), and performed a great deal of the intelligence “grunt” work. They personally examined prisoners and documents and maintained constant touch with the corps’ various formations in order to be fully conversant with the situation at the front. They had to know everything about the enemy’s tactics and habits, and be able to detect all changes in German dispositions and intentions. They kept lists of all locals who might prove valuable for their knowledge on local topography and other points of interest. They ensured that the intelligence filing system was maintained, and saw to it that vital information made it to those who required it, and in a speedy and efficient manner. By cooperating with the provost marshal branch, army intelligence, French and Belgian authorities and the intelligence police, these officers assisted with counter-espionage investigations. And, if all this was not enough to keep them busy, Intelligence Corps officers helped oversee the upkeep of maps; although this last duty was omitted from the revised “Instructions for Intelligence Duties, 2nd Army,” issued in March 1916.⁷² The efforts of these two men, working directly under the GSO2(I)’s guidance, and often unidentified in historical records and secondary sources, contributed enormously to Canadian battlefield successes.

Mitchell also had his own team of clerks that included a photographic clerk and a draftsman. This was a great improvement for Mitchell over his experiences in the 1st Canadian Division where he had to share the various clerks with other staff officers. At corps headquarters the clerks helped handle office routine, map work

⁷¹ NAC, R.G. 9 III C3, Vol. 4104, Folder 16, File 3. “Lecture on Intelligence,” by Brigadier General J. Charteris, to Second Staff College Course at GHQ, February 4, 1916.

⁷² NAC, M.G. 30 E61 (Mitchell Papers) Vol. 16, Folder: Western Front: Orders and Instructions, 1914 - 1915. “Duties of Intelligence Officers at Corps Headquarters,” September 21, 1915; Vol. 14, Folder 92. “Instructions Regarding Intelligence Duties, 2nd Army,” October 1915; “Instructions for Intelligence Duties, 2nd Army,” March 1916; and attached to this last document was one titled “Canadian Corps: Distribution of Officer’s Duties -- Intelligence Branch.”

and photographic analysis, for as General Currie noted: Photographs “were then [September 1915] beginning to be used extensively.”⁷³ Figure 5.1, “Intelligence in the Canadian Corps, May 1916,” illustrates something of the complexity of the intelligence organization working in the Canadian command by May 1916.

What the revamped intelligence system attempted to do was return some control over battlefields to commanders who, because of various circumstances -- the distance of their headquarters from the front, or because they were living underground, or due to the width of front their command occupied, or through a breakdown in communications -- lost control of events once an engagement was in progress. It did this in two ways. First, prior to engagements the intelligence system secured for planners and commanders the necessary details for arranging complex plans and for pre-calculating actions. Second, during a battle, brigade and battalion intelligence sections, along with FOOs, LOs and the corps squadron, gave commanders direct access to the front, and so acted as their eyes and ears. Martin van Creveld, in his book *Command in War*, calls the ability of commanders to cut through a unit's or formation's sometimes cumbersome channels of communication to see for themselves what was happening at the sharp edge ‘telescoping.’⁷⁴ This was an important development, because ‘telescoping’ gave commanders who were unable to directly view the action for themselves quick insight into events at the front. In other words, the intelligence system ‘telescoped’ commanders and others to the front in order that they might better see what was transpiring.⁷⁵

⁷³ Currie, “Historical Resume,” xviii.

⁷⁴ Martin Van Creveld, *Command in War* (Cambridge Mass.: Harvard University Press, 1985). The telescoping theme is developed throughout van Creveld's work.

⁷⁵ Interestingly, GHQ, in a note to 1st Army in March 1915, spoke about the telescoping capabilities afforded by a well organized intelligence system. “The rapid transmission of information is not impossible, even during the severest fighting, has been proved by the excellent results obtained by those formations in which the intelligence service has been carefully and methodically organized,” said the note. Unfortunately, the note did not reveal what that organization was, or give examples of how it was used. See NAC, M.G. 30 E61 (Mitchell Papers) Vol. 16,

In order to manage the mountains of information accumulating at the various headquarters, the Canadians produced numerous summaries, reports, charts, tables and maps. One such corps summary, not surprisingly, was referred to as the Summary of Information. This was a non-confidential report containing information of interest to both officers and men. It included extracts from newspapers (both friendly and enemy), and official communiqués, and discussed events along the corps' and other fronts. It was written in such a way that it was useless to the enemy if copies fell into their hands, yet was clear enough that men without maps could follow and understand the contents.⁷⁶ In January 1916, corps were instructed to stop issuing this summary, although a similar document prepared by higher command continued to be distributed.⁷⁷ The troops referred to these summaries as "Comic Cuts," which says something of their value as a source of information.⁷⁸

A second corps summary, known as the Intelligence Summary,⁷⁹ was prepared by corps intelligence to record important tactical information collected

Folder: Western Front, orders and instructions, 1914 - 1915. GHQ to 1st Army, March 15, 1915.

⁷⁶ NAC, M.G. 30 E61 (Mitchell Papers) Vol. 16, Folder: Western Front, orders and instructions, 1914 - 1915. 2nd Army memorandum, September 29, 1915.

⁷⁷ NAC, R.G. 9 III D1, Vol. 4676, Folder 3, File 10. Notice by C.H. Mitchell, January 17, 1916.

⁷⁸ F.C. Hitchcock, *Stand To: A Diary of the Trenches 1915-1918* (1937, Anthony Spagnoly, Gliddon, Norwich, 1988), 46. D.J. Goodspeed, in his book *Battle Royal. A History of the Royal Regiment of Canada 1862 - 1962* (Toronto: The Royal Regiment of Canada Association, 1962), 153, says that the troops referred to the Corps' Intelligence Summary (discussed in the next paragraph) as "Comic Cuts." A similar claim is made by W.W. Murray, *2nd Battalion*, 109. Their claims seem unlikely, however, considering the corps' Intelligence Summary was confidential, and not for the eyes of those below battalion headquarters or stationed in the front lines. The only Summaries the average soldier would regularly see were the non-confidential Summaries of Information. Hitchcock's claim is likely the most valid.

⁷⁹ Intelligence Summaries were sometimes called Summaries of Intelligence, or Summaries of Information. The content of these Summaries of Information differed from that contained in the Summaries of Information described above, and are different documents altogether.

Figure 5.1: Intelligence in the Canadian Corps, May 1916

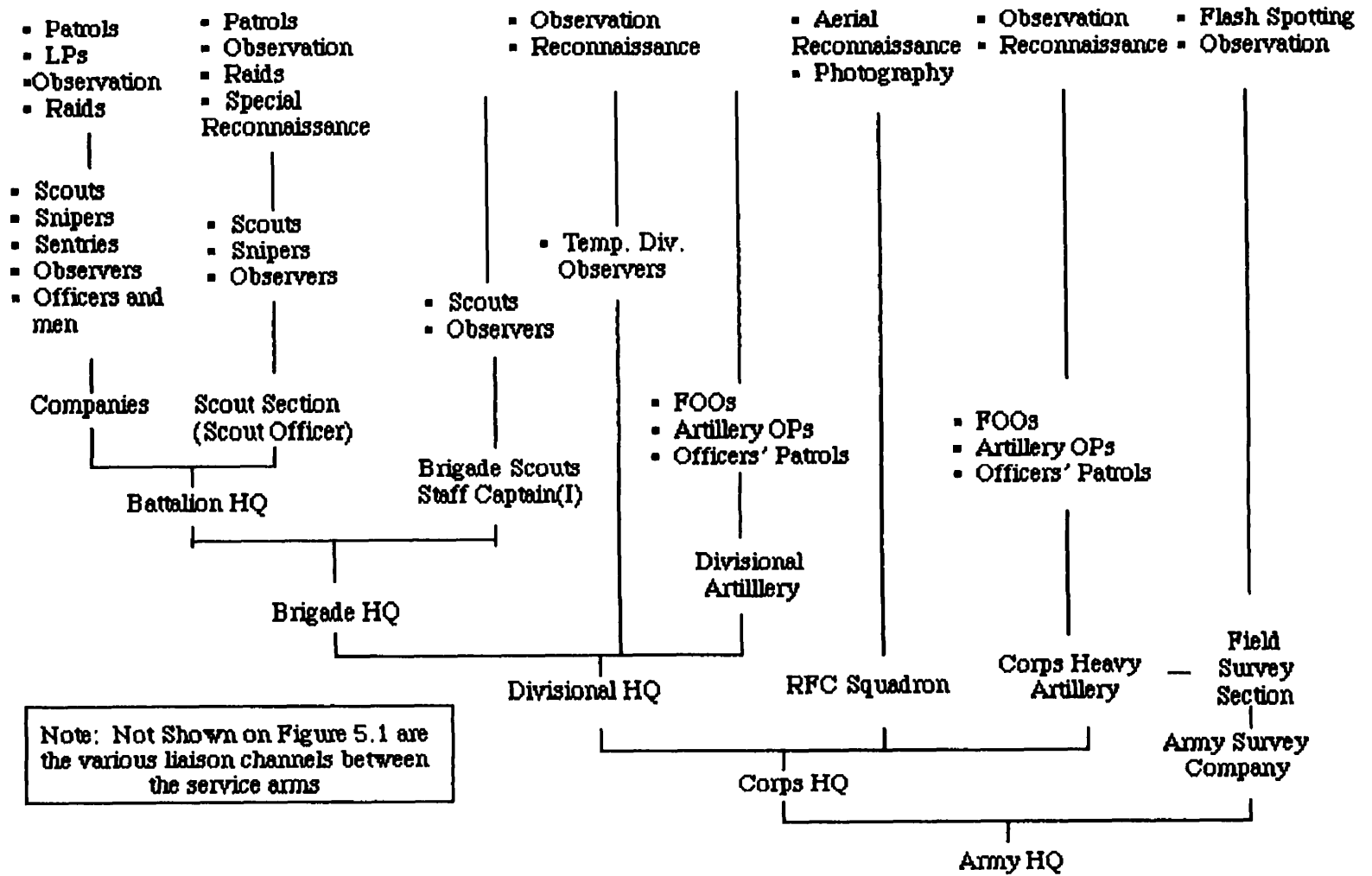

during the preceding twenty-four hour period “regarding the area in the immediate vicinity of the Corps.” It was confidential, and not issued to units below battalion, nor was it supposed to be taken into the front lines.⁸⁰ This report incorporated “information obtained from (a) Divisional Summaries (b) adjoining Corps Summaries and (c) General information from other sources furnished by the Army through its summary.” The Intelligence Summary was a two or three foolscap page-long report that covered such points of interest as the enemy’s

construction or improvement of trenches, listening posts, command posts, machine-gun and trench howitzer emplacements and trench tramways, as well as information regarding the location of telephone or telegraph wires, the tracks and roads normally used by reliefs, transport, etc., and any details regarding the enemy’s trenches obtained from prisoners or otherwise.

Space was available for “any information gained by aeroplane reconnaissance or otherwise as to possible targets for our guns,” and for information on the movements of German aircraft. These Summaries had a standard layout for quick and easy retrieval of information, that at the same time ensured only the most salient and sought after information was recorded.

The Corps Summary is necessary and useful in not only condensing and rearranging the important items of intelligence of the Corps and adjoining fronts, but in supplying to the units (down to Battalion H.Q.) a variety of information from outside sources which they would not otherwise get and which they seem to consider useful. The Corps Summary too, offers a medium for coordinating many of

⁸⁰ NAC, M.G. 30 E61 (Mitchell Papers) Vol. 16, Folder: Western Front, orders and instructions, 1914 - 1915. 2nd Army memorandum, September 29, 1915. Hahn states on page 236 of his book that corps Intelligence Summaries were only issued periodically, while a September 1917 document records that “The general opinion” at one conference “was in favour of the corps Intelligence Summary being issued weekly in normal warfare and daily during active operations” (R.G. 9 III C3, Vol. 4024, Folder 3, File 2. “Conference of Divisional and Artillery Intelligence Officers Held at Canadian Corps H.Q. 22-9-17). However, surviving corps-level Intelligence Summaries suggest a daily issue.

the items of intelligence making their collection the more useful to the units sending them in.⁸¹

Intelligence Summaries gave a snap-shot of the intelligence situation for a specific twenty-four hour period. They only discussed recent discoveries, and so did not include all details known about specific sectors. It was left to various maps, charts and tables to record the intelligence history of the front. Tables and charts, for example, were handy for recording information by target type, map reference, and so forth, and whose use helped avoid overcrowding maps with detail. The Canadians used separate maps to record changes in the enemy's line, enemy and friendly trench raid activity, enemy wire entanglements and strong points, and the physical features of no man's land. They also kept maps of enemy communication trenches, routes of approach, tramway lines, supply dumps, and counter attacks. Furthermore, the movements of German units and formations, hostile shelling, and wireless traffic were all recorded on maps. Any number of specialty maps were used to record information respecting specific situations. Maps made it easier "to visualize the enemy's organization, his lines of supply and movement, and thus to make easier the interpretation of his movements." For instance, maps revealed patterns in enemy raiding activity and shell fire that sometimes pointed to larger German initiatives. Similarly, intelligence officers plotted friendly raids on maps to ensure that their patterns were not revealing friendly plans to the Germans. Combined with other intelligence tools (photographs, sketches, target lists), maps proved an indispensable instrument in the intelligence arsenal.⁸²

⁸¹ NAC, M.G. 30 E61 (Mitchell Papers) Vol. 14, Folder 92. "Summaries of Intelligence. Memo Regarding Issue and Use," July 1916.

⁸² NAC, M.G. 30 E61 (Mitchell Papers) Vol. 3, Folder 11. Canadian Corps Intelligence Report: "Report on the Enemy's Position Between Bois Quarante and Bellewaarde Lake," July 15, 1916; Vol. 12. "Notes on Interpreting Maps," December 1915; Vol. 13, Folder 87: Wireless Stations; M.G. 30 E60 (Matthews Papers) Vol. 7, Folder 24: Maps 1917 - 1918.

Corps intelligence also produced on a monthly basis a larger and highly detailed report for army command that covered all aspects of tactical intelligence affecting the corps' front. This report contained the latest map up-dates and tactical analysis. Part of the report was in tabular form, listing and describing targets and their locations; other portions described the various terrain features such as buildings and craters. German positions were listed using German nomenclature. All locations were assigned map references from standard, army produced maps. Dates when the features were first located were provided, as was a history of the target. Army intelligence, by combining the information in these reports with that supplied by other corps, made assessments on German intentions along the army front, and evaluated the German's defensive and offensive capabilities.⁸³

Periodically the Canadian Corps produced a second large report, similar to the one just described, for corps and divisional consumption. The report produced in July 1916, for example, was 125 pages long, and incorporated the intelligence findings for the previous three and a half months. The information contained in the report was gathered by battalion scout sections, brigade observers, artillery observation officers, and from aerial photographs, locals, refugees, prisoners and deserters. Anything of tactical value was listed: search light locations, bridge descriptions (condition and construction), fords, defiles, tunnels, approach roads and tracks used by reliefs, forming-up locations, when specific communication trenches were used and how they were defended, information on the German system of patrolling and sentry duty, how strongly specific trench systems were held, German habits during a bombardment, normal German relief times, the location of specific strong points, the condition and number of rows of wire and

⁸³ NAC, M.G. 30 E61 (Mitchell Papers) Vol. 14, Folder Western Front, Orders and Instructions, 1914-1915. 2nd Army memorandum outlining the methods and subjects for reconnaissance of enemy positions, originally issued in August 1915, but received by the Canadian Corps on October 11, 1915.

how they were fastened down and whether or not they were electrified, enemy unit identifications with a brief description of their fighting history and, finally, a description of the countryside and nearby buildings.⁸⁴ Since each enemy position had to be destroyed or neutralized if the assaulting infantry were to survive the fire zone, knowing the specifics of individual targets was an important contribution to successful operations.

Divisions had to administer a great deal of information as well. As we saw in chapter three, very early in their front line career the Canadians began producing a daily divisional Intelligence Summary to help in this regard. After more than a year of use and refinement, the Canadian Corps opined that these Intelligence Summaries fulfilled their “requirements in an admirable manner as [they returned] to the Brigade in the early afternoon the detailed information gathered by the Infantry and Artillery Brigades up to the morning of the same day.” This quick return of intelligence enabled “both the Brigade Staff and Regimental Officers to still plan any tactical work for the approaching night which may be based upon the Intelligence received.”⁸⁵ To ensure uniformity in reporting, beginning in late August 1915, battalion and brigade intelligence reports utilized headings identical to those of the divisional Intelligence Summary.⁸⁶

In the autumn of 1915, Canadian divisions began producing monthly Intelligence Summaries in addition to the daily ones. These were massive tomes dealing with every conceivable aspect of intelligence concerning the enemy’s position and the intervening no man’s land, and were very similar to the monthly

⁸⁴ NAC, M.G. 30 E61 (Mitchell Papers) Vol. 3, Folder 11. Canadian Corps Intelligence Report: “Report on the Enemy’s Position Between Bois Quarante and Bellewaarde Lake,” July 15, 1916.

⁸⁵ NAC, M.G. 30 E61 (Mitchell Papers) Vol. 14, Folder 92: “Summaries of Intelligence. Memo Regarding Issue and Use,” Canadian Corps, July 1916.

⁸⁶ NAC, R.G. 9 III C3, Vol. 4140, Folder 1, File 3. “Guide For Daily Intelligence Summaries. 1st Canadian Division,” by Lieutenant Colonel Mitchell. This “Guide” was later issued to the 2nd Canadian Division as well.

report that corps produced (discussed above). The value of these monthly reports was in their detail. They contained everything that was known about the enemy's position; an obviously vital tool for planning purposes. The 2nd Division's first such report came out in October 1915, and was an immediate hit with both the divisional and corps commanders. So impressive was the report for its thoroughness that Major Parsons, the division's senior intelligence staff officer, explained the division's intelligence system to Sir Herbert Plumer, the 2nd Army commander, when Plumer visited the division on November fourteenth. On the seventeenth, Major Ingham, from the 6th British Corps, also came by for a look, and was impressed. Ingham, in turn, invited Parsons to review the intelligence arrangements of the 6th Corps. Two days later a 5th Corps intelligence officer saw Parsons about the division's intelligence gathering, and when General Sir Douglas Haig, the commander of the BEF, visited the 2nd Division in January 1916, Parsons recorded that he "had quite a chat with him about the way I [Parsons] carried out intelligence work." Haig then invited Parsons to GHQ to see how intelligence operated there.⁸⁷

In May 1916, brigades started using log books to bridge the difficulties of collating and tracking information throughout an area as large as a brigade sector. The system came to the Canadians from the British after a memo from the 2nd Army praised its practicality. Brigade log books worked as follows: each sub-square of a 1/10,000 scale trench map displaying a given brigade's frontage was cut out and pasted to the top of a page in an 'Army Book 152' (essentially a book of

⁸⁷ NAC, M.G. 30 E117 (Parsons Papers) Vol. 3. Diary entries, November 14, 17, and 18, 1915, and January 4, 1916. In addition to the visits mentioned, the 20th Battalion also hosted an officer from the 9th Royal Sussex Regiment in January 1916. He was there to study Canadian battalion-level intelligence. He was very pleased with what he learned. See D.J. Corrigan, *The History of the Twentieth Canadian Battalion (Central Ontario Regiment) Canadian Expeditionary Force in the Great War, 1914-1918* (Toronto: Stone & Cox Ltd., 1935), 45. Corrigan was the Battalion's first scout officer.

lined paper). All data affecting that sub-square was recorded in the log book. As Major Parsons declared: "We want to know everything that happens under sub-squares on our map."⁸⁸ The information was dated, a description of the activity recorded, and the exact location by map reference provided. It was a simple way to record and retrieve intelligence. When relieving brigades were handed the log book by outgoing commands, they immediately held the complete intelligence history of the German position opposite. It was a vast improvement over earlier relief procedures when intelligence might be recorded in several locations (Summaries, on various maps, in commanders' notebooks, etc.), or not recorded at all. In August 1916, all OPs began using log books, too, giving incoming observers the entire intelligence history of the relevant section of line that they were observing.⁸⁹

An incredible amount of information also arrived at battalion headquarters. With each company in the line preparing patrol reports, observation reports, situation reports, and listening post reports, it did not take long to submerge battalion commanders in bits and pieces of information. To help coordinate this mass of information, the battalion adjutant, and later the battalion scout officer, collected and collated company, platoon, patrol and other reports into a daily battalion intelligence report.⁹⁰ By August 1915, the form that battalion intelligence reports took was standardized along the lines of the divisional Intelligence Summary. This improved information exchange among the various levels of command, and eased cross-referencing and data retrieval; it also helped officers collect relevant intelligence and report on the more salient information regarding

⁸⁸ NAC, M.G. 30 E117 (Parsons Papers) Vol. 4, Folder 23. From a lecture by Major Parsons, 2nd Canadian Divisional Staff Officer (intelligence), August 7, 1916.

⁸⁹ NAC, R.G. 9 III C3, Vol. 4104, Folder 16, File 3. Lt. Col. Mitchell to 4th Brigade, May 19, 1916; Vol. 4100, Folder 4, File 11. Second Canadian Division to brigades concerning decisions made at an intelligence conference held on August 9, 1916.

⁹⁰ NAC, M.G. 30 E239 (Hilliam Papers) Folder: Field Messages 1915, 1917. Officer commanding 5th Battalion to company commanders, October 8, 1915.

their front. One of the scout section's NCOs assisted the scout officer in preparing these returns, and ensured that "any reports of an ambiguous nature [were] checked at their source." After their completion, scout officers gave the battalion intelligence reports to their battalion commander for approval, with a copy then being sent to brigade headquarters.⁹¹ At brigade headquarters the brigade major, later the staff captain(I), collected and collated the battalion reports, brigade observer reports, and anything of interest from other sources, and pieced together a brigade intelligence summary, a copy of which was forwarded to division.⁹²

Around February 1916, battalions began using trench log books for recording information bearing on the front line trenches. These were very similar to brigade log books already described, but as they covered a much smaller area, they did so in far more detail. A photograph of the area was usually placed in the log. Most logs, in addition to the map sub-square on a scale of 1/10,000, also contained a 1/5,000 scale map of the same area. This latter map was often drawn by a scout officer or some divisional intelligence officer.⁹³ Battalion scout officers were normally responsible for log book upkeep, obtaining most of the information from patrols, OPs, and adjacent commands.⁹⁴ Information also came from divisional and

⁹¹ NAC, M.G. 30 E300 (Odlum Papers) Vol. 24, Folder: Trench Discipline and Organization, March 1916 - April 1918. Second Brigade to Units, March 29, 1916; R.G. 9 III C3, Vol. 4162. 8th Brigade to 2nd and 4th Canadian Mounted Rifles, February 9, 1916; Vol. 4111, Folder 39, File 3. "Report on the Organization and Duties of the Scout Section Employed by the 20th Canadian Infantry Battalion," May 23, 1916, and "Memorandum Relating to the Establishment[,] Organization and Duties of Scout Sections 4th Canadian Infantry Bde." The 4th Brigade also requested a report be submitted by wire before 8:00 a.m. each day regarding patrol work conducted during the night and any other "events of importance." No doubt other brigades did similar.

⁹² NAC, M.G. 30 E300 (Odlum Papers) Vol. 16, Folder: The Landing at St. Nazaire, Feb. - Mar. 1915. Odlum's monograph; R.G. 9 III C3, Vol. 4074, Folder 1, File 17. 3rd Brigade Intelligence Report, August 16, 1915.

⁹³ NAC, R.G. 9 III C3, Vol. 4140, Folder 1, File 6. "Canadian Corps. Instructions for Keeping Log Books," February 1916.

⁹⁴ NAC, R.G. 9 III C3, Vol. 4111, Folder 39, File 3. "Report on the Organization and Duties of the Scout Section Employed by the 20th Canadian Infantry Battalion," May 23, 1916.

corps level Intelligence Summaries, trench maps and aerial photographs. In all cases entries were dated, and obsolete information crossed out. Since the logs remained in the trenches, and were handed over to incoming garrisons during a relief, incoming commands had available to them a written record of all that had occurred in their sector, and so could quickly come to terms with their surroundings. In addition, log books insured "continuity of policy in the construction of new trenches, in patrolling work, and in the observation of the enemy's defences and habits."⁹⁵ If properly maintained, log books (both the brigade and battalion variants) were ideal instruments for storing and retrieving information, and an effective method for keeping track of the constantly changing front lines.

Unfortunately, log book maintenance was uneven. Some units and posts were not as adept as others in keeping logs up to date, rendering some logs useless. Experiences in 1916 showed that when each post and battalion maintained its own particular log, the quality of the information found in some logs left much to be desired. The problem was that there were too many hands responsible for their upkeep, and there was no quality control, so the value of the entries varied considerably from one command to another. The constant rotation of troops through these positions worsened the predicament, as continuity was lost with each new man. Since divisions remained in position longer than their subordinate parts, in 1917 it came to pass that these commands assumed the task of coordinating, compiling and distributing log books, thus securing the completeness of information contained in them. Divisions then distributed the completed logs to the various forward posts, companies and batteries, thus ensuring that all recipients worked with the same information. New logs were issued periodically as required.

⁹⁵ NAC, R.G. 9 III C3, Vol. 4140, Folder 1, File 6. "Canadian Corps. Instructions for Keeping Log Books," February 1916.

In the interim, divisions provided updates on confirmed targets and sightings for inclusion in the logs already apportioned. Continuity of information was thereby sustained, as each command and post held all the facts known and deemed relevant by their parent division.⁹⁶

Around the time of Passchendaele in October 1917, Canadian Corps headquarters, too, began involving itself in the production of log books. The resultant corps log was in addition to the divisional log, and contained information on all confirmed targets along the corps' front. It included details from sources not available to divisions, such as discoveries made by army sound rangers and flash spotters. Each division received one copy of the corps log for its own use, as did the heavy artillery and the various artillery groups. All confirmed targets were assigned a number by corps headquarters which divisions copied into their own log books for distribution to lower level commands and posts. With the production of corps logs, officers throughout the corps came to share exactly the same information, and the same target numbers. This was of enormous benefit to liaison officers and others when communicating with those outside their immediate circle. The assigned numbers made it practically impossible to mistake the target under discussion, while the sharing of knowledge fostered cohesion.⁹⁷ Beginning in February 1918, the corps decided that all company commanders in the line would also receive a copy of the corps log map corresponding to the area their battalion occupied, and to a depth of 2,000 yards behind the German front line trench system. They were also issued an annotated mosaic of the battalion sector on a

⁹⁶ NAC, R.G. 9 III C3, Vol. 4025, Folder 7, File 5. "Notes on Intelligence Reports of Brigade and Battalion Intelligence Sections," December 30, 1917; R.G. 9 III C4, Vol. 4342, Folder 3, File 21. 7th Brigade to subordinate commands, February 5, 1917; J.E. Hahn, *The Intelligence Service*, 157-158.

⁹⁷ NAC, R.G. 9 III C3, Vol. 4083, Folder 4, File 10. "Report on Conference of Divisional Intelligence Officers Held at Canadian Corps H.Q. - 7/12/17." The Corps also tracked unconfirmed targets, compiling information on them in the 'Day Book' until confirmed; Hahn, *Intelligence Service*, 158.

1/5,000 scale. Battalion commanders, meanwhile, received a copy of the corps log map and book covering the brigade front, a 1/5,000 scale annotated mosaic, and a 1/20,000 scale harassing fire map.⁹⁸ Log books proved such a useful tool for recording and retrieving information that the 1st Army, in February 1918, adopted the log book system for all corps and divisions operating under its command.⁹⁹ The log book system even caught the eye of an American observer visiting the Canadian Corps at the end of 1917. In his report to his American superiors he stated:

In the Canadian Corps intelligence has apparently reached a very high state of efficiency. They have developed a system which is known as the 'Log system.' This is based on the idea of a continuous running report on the activities of the enemy in their sector, accompanied by a graphic illustration as to what is going on so that in place of having a series of daily statements, which are bound to be more or less disconnected, they have a constantly increasing picture of the Germans.¹⁰⁰

Even before these later improvements were made, the log books of 1916 proved a great innovation for managing the mountains of information produced by trench warfare. The permanency of the records ensured that the lives of scouts were not endangered by their being asked to repeat work already completed.

Companies and smaller units maintained records and prepared daily reports, too. The more formal reports included patrol reports, observation reports, ammunition returns, strength returns, company log books, and the twice daily

⁹⁸ NAC, R.G. 9 III C3, Vol. 4024, Folder 3, File 2. Corps notes on conference held at corps HQ, February 4, 1918.

⁹⁹ NAC, R.G. 9 III C1, Vol. 3920, Folder 2, File 7. Notes from 1st Army conference held February 12, 1918.

¹⁰⁰ LTC Arthur L Conger Papers, U.S. Military History Institute, Carlisle Barracks. "Headquarters American Expeditionary Forces, Office of the Chief of Staff, Intelligence Section," January 1, 1918. My thanks to Dr. John Ferris of Calgary University for sharing this document with me.

situation reports.¹⁰¹ Company and scout officers also interviewed patrolmen, observers, listening post men and others in an effort to glean from them information not recorded in their written reports -- information that company commanders and scout officers then passed on to battalion headquarters in their written returns. From the various reports, and through word of mouth, officers and men learned about their environment, and made written or mental notes on things like where to duck to avoid sniper fire, where German wire and machine gun posts were situated, and what new work was under construction. It was through living the trench experience day in and day out that men at the front came to grips with the details of their surroundings. One either remembered or became a casualty.

The artillery introduced standardized reports in 1915 to control information as well. Table 5.1, "Battery Intelligence Report," offers an example of the headings used on one such form put to use by Canadian batteries in January 1916.¹⁰² Each FOO post also had its own log book, maintained by the FOO.¹⁰³ These logs contained sketches of important points, such as machine gun posts and buildings, along with their map references. They worked in the same manner as log books kept by the infantry, and were indexed for quick retrieval of information. The logs remained with the post upon relief. As artillery reports made their way up the chain of command they were sifted and condensed until they reached divisional

¹⁰¹ Company logs were not, at this time, intelligence logs as described above, although they could contain useful intelligence. The Canadian Corps' "Trench Orders" of October 21, 1915 states that company logs were used to enter "up daily the work done" by companies in the line. Companies handed these logs over to incoming commands during a relief. NAC, M.G. 30 E61 (Mitchell Papers) Vol. 16, Folder: Western Front: Orders and Instructions. "Canadian Corps Trench Orders," October 21, 1915.

¹⁰² NAC, R.G. 9 III C4, Vol. 4291, Folder 4, Files 1, 2, and 3. Contained therein are examples of Artillery Intelligence Reports prepared by batteries and artillery brigades. These were used to create Table 5.1. An earlier report, dated November 1915, did not have columns 3, 4, 5, 7, and 9.

¹⁰³ NAC, M.G. 30 E157 (Crerar Papers) Vol. 22, Folder 3. 3rd Artillery Brigade Order No. 62.

headquarters where intelligence officers incorporated them into the division's Intelligence Summary. Again, as with the infantry, gunners had the use of aerial photographs, maps, various charts and tables, along with divisional and corps Intelligence Summaries to aid them in their work.

By early 1916, the Canadians had transformed their intelligence system in a major way. A professional approach was adopted; intelligence personnel were now considered specialized, elite troops, and intelligence officers no longer practiced their craft part-time. The expansion of the intelligence service, while reflecting the growing size of the Canadian commitment to the war through the size of its formations, was also due to the Canadians' increased desire for detailed planning, and for full and complete information on the enemy's position before committing troops to battle. For the remainder of the war, Canadian planners sought every possible detail to help them in their bid to reduce battlefield friction, and it was the Canadians' hope that the intelligence system developed over the winter of 1915 and 1916 fit the bill. The need to micro-manage events, however, flooded the various headquarters units with mountains of information that was itself not easily controlled. New managerial techniques, such as log books, were introduced to maintain some sense of order and to prevent information overload. Highly trained and skilled individuals also helped prevent information chaos. Through it all, intelligence gathering had become a professional and specialized function of the utmost importance on the road to victory.

CHAPTER SIX

ST. ELOI TO MOUNT SORREL: APRIL - JUNE 1916

The professionalization of intelligence begun in 1915, continued unabated in 1916. The first test of the Canadian Corps' intelligence system came at the Battle of the Craters, or St. Eloi, in April, where it put in a second-rate performance. Success at Mount Sorrel in June, however, rekindled Canadian confidence, and set the pattern for later victories. Showing professional maturity, the Canadians studied these engagements for lessons on how to wage and win battle, and for lessons on how intelligence might better contribute to that success. At the same time, the control of battle by battalion and higher commanders through pre-planning continued in 1916. Detailed plans, based on massive stockpiles of information, let Canadian planners calculate complex movements in advance of any actual fighting. Soldiers learned, in the finest detail, where and when to proceed. Such intimate control was necessary because troops remained inexperienced with small unit tactics and, once over the top, communications between the foremost positions and battalion headquarters persisted in breaking down. This usually left battalion commanders impotent to intervene, at least until information filtered back, perhaps several hours later. Even then, news was incomplete at best. Brigade and battalion intelligence sections, with their potential telescoping capacity, helped clear the air, but could not always penetrate the dust, smoke and mud of battle, or get their messages through. Command ignorance of the front line continued to be the norm. Precise, highly complex orders compensated for this ignorance. Commanders unable to control the action once it was underway attempted to do so by directing its

flow beforehand. Such elaborate planning, of course, consumed an enormous quantity of high quality intelligence, and so 1916 saw the Canadians struggling to find the right mix of intelligence technique and organization necessary to sate this appetite. Where the Canadians were without the controlling hand of detailed plans, such as during their defensive battles at the St. Eloi Craters in April, and during the German attack at Mount Sorrel in June, chaos ensued as command and control systems shattered under the weight of the German onslaught. But even in defeat they learned important lessons, and used them to improve their assault tactics and their intelligence organization.

The fight for the St. Eloi craters was the nadir of the Canadian combat intelligence service. It was not a large action, and it had little bearing on the larger outcome of the war, but it was a confused and humiliating defeat for the 2nd Canadian Division fighting in its first significant engagement, and for the Canadian Corps as a whole. The fight for the craters was, as mentioned above, the first major test for the Canadians' revamped intelligence organization, a test it largely failed. The result was that an entire division was left lost and floundering for ten days without its even knowing it. The good news is that the Canadians learned from this debacle, and such a poor showing was not repeated.

The 2nd Canadian Division entered the front lines around St. Eloi during the night of April third, three days earlier than first planned. The original intention was for this division to relieve the British 3rd Division on the sixth, and only after the British had firmly secured and consolidated the ground. The British had been actively fighting the Germans around St. Eloi since March twenty-seventh, the day they detonated several mines lying under the German lines. The fight for the resultant craters was brutal, and by April third the strength of the 3rd British Division was spent. The 2nd Army decided to replace the depleted British division with one from the Canadian Corps three days ahead of schedule and, most

importantly, before the front was stabilized. Battalions from the 6th Canadian Brigade went forward to relieve the exhausted front line British units located in the new crater line.¹

The new line was barely a line at all, it was more a series of smashed trenches and isolated shell holes. All who reconnoitred the area agreed that the location was abominable. Dead and wounded lay everywhere, and mud made movement difficult. The British had not consolidated the position, nor did they know or pass to the Canadians information on the exact location of the German line. There were no communication trenches in the centre of the Canadian front, nor were there observation posts from which to observe the countryside and the German lines. The area received constant and heavy shelling, and there were few wire entanglements remaining to protect the front. The Germans held the surrounding high ground overlooking the Canadian location, and so witnessed all Canadian movement and preparation. The Canadians had no such view of the German line, as the lips of the craters formed by the British mine explosions were so vast (the largest crater was fifty feet deep and 180 feet in diameter) that they blocked the view of the German trenches to ground observers.² This rendered forward observation by FOOs a hopeless task.³ During daylight hours German machine gun and artillery fire regularly disrupted communications to the rear. In

¹ G.W.L. Nicholson, *Official History of the Canadian Army in the First World War. Canadian Expeditionary Force 1914-1919* (Ottawa: Queen's Printer, 1962), 139 - 140.

² National Archives of Canada (NAC), Record Group (R.G.) 9 III C1, Vol. 3842, Folder 42, File 5-6. Report on 2nd Canadian Division's Operations at St. Eloi; Manuscript Group (M.G.) 30 E241 (Macintyre Papers) Vol. 1, Diary-memoir entry April 6-7, 1916; M.G. 30 E46 (Turner Papers) Vol. 2, Folder 10. "Report on Action of 2nd. Cdn. Div. Scouts from April 6th to April 12th, 1916;" R.G. 9 III C1, Vol. 3842, Folder 42, File 5-6. Sixth Brigade Report on Operations at St. Eloi, by Brigadier General Ketchen, April 12, 1916; R.G. 24, Vol. 1862, Folder 94: St. Eloi: Survey of Information Available.

³ G.W.L. Nicholson, *The Gunners of Canada. A History of the Royal Regiment of Canadian Artillery, Vol. 1, 1534 - 1919* (Toronto: McClelland & Stewart, 1967), 250.

vain, signalmen tried to maintain telephone connections, but shell fire severed the cables almost as fast as they were repaired. Runners in the open had little hope of surviving any attempted crossing of the intervening ground. By April sixth, after some seventy-two hours in the line, Brigadier-General H.D.B. Ketchen, commander of the 6th Brigade, claimed eighteen runners had been killed trying to deliver messages.⁴ Intelligence transmission, and command and control inevitably suffered.

Things had not gone well for the Canadians from the moment the relief began on April third. Captain D.E. Macintyre, who at the time of the fighting was the staff captain(I) for the 6th Brigade, complained that

Owing to the constant fighting it had been impossible for us to send any advance parties up to reconnoitre the line. We had tried, but the English would not allow any of them in the line; said they would be in the way while operations were going on. So when we took over on the night of the 3rd we took a leap in the dark.⁵

British restrictions notwithstanding, the 27th and 31st battalions carried out some minor reconnaissances before their entry into the trenches. These were rendered useless, however, when these two units occupied different sections of trench from those they had reconnoitred. Ideally, incoming units learned about the front line situation from outgoing commands. Unfortunately, the Canadians learned little of their new surroundings from the British who, in their exhausted state, did not even supply an up-to-date situation report. Nor did the British know with any degree of certainty where exactly their positions were relative to the enemy. Indeed, a British

⁴ NAC, R.G. 24, Vol. 1891, Folder 107. "Notes on St. Eloi Fighting," from a verbal statement by Ketchen to Lieutenant W.F. Bradley representing the Canadian Eye Witness.

⁵ NAC, R.G. 24, Vol. 1891, Folder 107. Excerpts from War Diary, 6th Brigade, April 4, 1916; also M.G. 30 E241 (Macintyre Papers) Vol. 1, Diary-memoir entry April 4, 1916.

officer acting as a guide for the Canadians got lost leading them to the front.⁶

Private Donald Fraser, of the 31st Battalion, recalled:

The English Tommies we relieved could furnish us with no information regarding the whereabouts of the enemy or our immediate connections. We could only look into an impenetrable darkness and conceive in our minds the general situation surrounding us. The whole place was wrapt in gloomy mystery; all sense of direction was lost; around was a chaos of shell holes and mud heaps.⁷

A surprise German assault in the early hours of April sixth caught Canadian battalions conducting a relief, making a bad situation worse. This attack regained for the Germans the ground lost to the British during the eight days of fighting between March twenty-seventh and April third. The 2nd Army ordered the Canadians to retake the ground. Men from the 28th and 31st Battalions, however, got lost in their counter-strike, and in the ensuing confusion mistakenly claimed to have retaken the craters numbered four and five (there were seven large craters in total). They had in fact occupied two smaller craters identified as six and seven. The Canadians did not discover the misidentification for ten days, and all action taken by the Canadians in the area between the sixth and sixteenth of April was

⁶ NAC, R.G. 24, Vol. 1891, Folder 107. "Notes on St. Eloi Fighting," from verbal statements by Brigadier General Ketchen and Lt. Col. Snider, to Lieutenant W.F. Bradley representing the Canadian Eye Witness; Vol. 1826, Folder GAQ 5-76. "Notes on Conversation with Major A. Styles, DSO, August 18, 1922;" Vol. 1862, Folder 94: St. Eloi: Survey of Information Available; R.G. 9 III C1, Vol. 3842, Folder 42, File 5-6. Report on 2nd Canadian Division's Operations at St. Eloi; R.G. 9 III C3, Vol. 4131, Folder 11, File 5. Report of the 27th Battalion. M.G. 30 E241 (Macintyre Papers) Vol. 1. Diary-memoir, entries for April 3 & 4, 1916; Thomas P. Leppard, "Richard Turner and the Battle of St. Eloi" (University of Calgary, Unpublished Masters Thesis, 1994), 39-42; Tim Cook, "The Blind Leading the Blind. The Battle of the St. Eloi Craters," *Canadian Military History* 5.2 (Autumn 1996): 24 - 36. H.C. Singer and A.A. Peebles, *History of Thirty-First Battalion C.E.F. From its Organization November, 1914 to its Demobilization June 1919* (privately printed, 1939), 72-73.

⁷ Fraser, Donald, *The Journal of Private Fraser, Canadian Expeditionary Force 1914-1918*, ed. Reginald Roy (Sono Nis Press, 1985; reprint, Nepean, Ontario: CEF Books, 1998), 113.

based on the mistaken assumption that they were actually in craters four and five. It was a humiliating intelligence blunder.

This gaffe, however, was easy enough to make. Lieutenant Colonel A.H. Bell, commanding the 31st Battalion, noted that there were at least seventeen craters in the general area of the four large craters numbered two through five, and all were bigger than anything the Canadians had ever seen before.⁸ One officer recalled after the war how crater six, “did not seem big enough to answer the description given [for crater five], but as it was at the left of the line of craters it was assumed that it must be Crater No. 5.”⁹ Captain Macintyre, too, was not surprised over the confusion of the craters. He wrote:

The explanation was quite simple. Our first parties had been unable to find the slightest trace of our old front line which would have given them something to start from; When they came to crater 7 it was by far the largest they had ever seen and they thought it must be the one they were sent to take. Next on the west was Crater 6 a very old crater full of water. They, therefore, thought they held five (really 7) and looked over to 4 (really 6)[.] From 6 they could see 5 and 4 which they took to be 3 and 2. It was a natural mistake and as that region was full of craters and there were no landmarks in the way of trenches and everything had to be done at night and in deep mud it was no wonder everyone went wrong.¹⁰

So much for making the error in the first place.

However, the crater misidentification should not have persisted for ten days and through three brigade reliefs.¹¹ Available maps and photographs of the area might have helped clarify the situation, but unfortunately some commands

⁸ NAC, R.G. 24, Vol. 1862, Folder 94: St. Eloi: Survey of Information Available.

⁹ NAC, R.G. 24, Vol. 1826, Folder GAQ 5-76. “Notes on Conversation with Major A. Styles, DSO, August 18, 1922.”

¹⁰ NAC, M.G. 30 E241 (Macintyre Papers) Vol. 1, Diary-memoir entry April 8, 1916. This is obviously a post war, or post battle addendum, as the Canadians did not realize the extent of their error until the sixteenth.

¹¹ The 4th Brigade relieved the 6th Brigade during the night of April seventh, and the 4th Brigade, in turn, was relieved by the 5th Brigade during the night of April twelfth.

apparently did not receive them. Captain Macintyre, when addressing these complaints in an April eleventh letter to the brigade's battalions, recorded that battalions received on April first "3 copies each of VOORMEZEELE and HOLLEBEKE, scale 1/10,000." These were maps of the St. Eloi area. On April second each battalion received one copy of the St. Eloi special map showing the craters and the new British line marked on it -- albeit, the line on the map did not match the reality on the ground, where all was confusion and disorder.¹² On the fourth, twenty more copies of Voormezeele and Hollebeke maps were distributed, as were five more St. Eloi specials (scale 1/5,000). On the sixth, five aerial photographs of the craters were distributed. Macintyre acknowledged, though, that

in many cases officers did not get maps which have been distributed to them and a great many officers were never shown the aeroplane photographs. The latter are hard to obtain and when sent to battalions every officer should have an opportunity of studying them, and if possible, lecture his men on them, so that they may become in some measure familiar with the situation.

Every assistance will be given from this office in the manner of reproducing our trenches on the printed maps, but once the battalions have one showing our trenches, they should have no difficulty in getting somebody in the scout section to reproduce as many copies as required.¹³

Had these photographs and maps been properly distributed the crater misidentification may not have lasted quite so long, as they should have been sufficient to enable commanders to orient themselves on the ground.

The intelligence organization, whose principal task was to dissipate the fog of war and telescope commanders to the front, failed at St. Eloi. The fact that three

¹² NAC, R.G. 24, Vol. 1891, Folder 107. Excerpts from War Diary, 6th Brigade, April 4, 1916; also M.G. 30 E241 (Macintyre Papers) Vol. 1, Diary-memoir entry April 4, 1916; R.G. 9 III C3, Vol. 4131, Folder 9, File 5. Macintyre to units, April 11, 1916.

¹³ NAC, R.G. 9 III C3, Vol. 4131, Folder 9, File 5. Macintyre to units, April 11, 1916.

of the four battalions making up the 6th Brigade entered the fray on April third without their intelligence officer surely helps explain why the error in identifying the craters occurred and persisted. The scout officers for the 27th and 31st Battalions were on leave and not replaced, while the scout officer for the 29th Battalion was commanding a company in the absence of one of the company commanders. He, too, was not replaced. The 28th Battalion, the only battalion in the brigade with an on duty intelligence officer, was in reserve during the 6th Brigade's initial tour. In effect, the Canadians joined one of the most confusing battles faced by the corps without the centralizing and coordinating hand of their battalion intelligence officers, suggesting that some commanders believed that unit efficiency was not unduly impeded by the scout officers' absence. Not that the presence of three intelligence officers would have prevented the misidentification of the craters, but the misreading of the situation may not have lasted as long as it did had they been on hand. Battalions would have had available to them officers dedicated to gathering information and identifying features in no man's land. In their absence there was no central battalion authority solely responsible for coordinating patrols and observation, for seeing that scouts and observers were properly utilized, and for sifting, reading, and receiving reports on the situation unfolding along the front. These tasks were thrust upon already overworked and exhausted unit commanders and their staffs, to the detriment of the division and the corps. Meanwhile scouts, too, were worn out and improperly utilized in non-intelligence gathering roles. In addition to making periodic reconnaissances of the front, they spent an inordinate amount of time acting as guides and runners. The 6th Brigade, for example, recorded how

It was found necessary from the beginning owing to the insufficient telephonic communication to employ runners between the front line and battalion headquarters. The scouts were naturally the people to use for this work and were kept at it continuously, rendering very

valuable service, frequently carrying messages over-land under fire.¹⁴

Under these circumstances examination of the front took a back seat.

The mishandling of battalion intelligence sections was not the sole reason for the failure to accurately identify the craters. Commanding officers and brigade and divisional staff officers who physically observed and reconnoitred the lines failed, too, to pick up on the error. Each incoming brigade assumed all was as reported to be, even though from the initial German counter attack on April sixth, there was mounting evidence that the Canadians were not in the craters they thought they were. Early on the sixth, for example, Captain Macintyre, with a number of brigade scouts, established an observation post in the town of Voormezele in order to observe the German assault, and keep Ketchen, the brigade commander, informed on how the fighting was progressing.¹⁵ Macintyre reported that his team saw Germans digging unmolested on the lips of craters two through five. In Macintyre's words:

Scouts Parker, Griffin and Lindsay were with me and they saw what I did. They were all trained observers, doing their work calmly apart from the confusion of the struggle, but nevertheless, by reason of their telescopes, occupying ringside seats. They, like myself, recognized the German uniforms and even the shovels they used. In fact we could see their faces, and I have a distinct recollection of one fellow pausing in his labour and looking our way with a grin.¹⁶

In the interim, Ketchen received word that Canadian ground troops were in craters two and three. Ketchen was then faced with a choice of who to believe --

¹⁴ NAC, M.G. 30 E46 (Turner Papers) Vol. 2, Folder 10. "Report on Action of 2nd. Cdn. Div. Scouts from April 6th to April 12th, 1916."

¹⁵ NAC, R.G. 9 III D1, Vol. 4688, Folder 42, File 14. Ketchen to Max Aitken, July 28, 1916.

¹⁶ NAC, R.G. 24, Vol. 1825, Folder GAQ 5-67. "The Fight For The Craters," by Lt. Col. Macintyre, circa 1936; M.G. 30 E241 (Macintyre Papers) Vol. 1. Diary-memoir entry April 6, 1916.

the word of ground troops supposedly on the scene, or the word of his recently appointed intelligence officer observing the action through a telescope from behind the lines.¹⁷ As Ketchen was "loathed" to shell craters two and three for fear of striking his own men, he chose to believe the ground troops.¹⁸ He chose incorrectly. When evaluating the various reports, Ketchen should have placed greater emphasis on Macintyre's messages, as they were fresh, having been received by brigade headquarters by telephone soon after the observations were made. The reports of the infantry supposedly in the craters -- and probably sent by runner -- would have been comparatively older. The infantry were also in an exhausted state, as was noted by a British FOO from the 54th British Battery that was supporting the Canadians supposedly in craters four and five (really craters six and seven). This FOO's comments are revealing for two reasons. First, he had been in the line since before the Canadians arrived, yet was himself confused over the real position of the craters. Second, he noted that troop exhaustion made it "difficult to obtain coherent statements of positions."¹⁹ The exhaustion of personnel should have been taken into account by brigade headquarters when receiving and evaluating front line reports. Macintyre, not under fire or having slogged through the mud, would have seen events from a relatively fresher perspective.

With due regard to Ketchen, it needs to be stated that Macintyre, too, became confused over exactly which craters the Germans occupied. Perhaps Ketchen recognized this as well, but this is speculation. In his report dated April ninth concerning events on the sixth, Macintyre wrote that the Germans held craters

¹⁷ Macintyre had only been a staff captain(I) for a few weeks, although previously he had served as the 28th Battalion's scout officer, and was instrumental in planning the raid of January 30/31, 1916, discussed in Chapter Four.

¹⁸ NAC, R.G. 24, Vol. 1825, Folder GAQ 5-67. "The Fight For The Craters," by Lt. Col. Macintyre, circa 1936.

¹⁹ NAC, R.G. 9 III C1, Vol. 3842, Folder 42, File 5-6. "Reconnaissance of Crater No. 2," 9.05 a.m. April 8, 1916.

two through five during the morning, but only craters two and three in the afternoon (suggesting that the Canadians held craters four and five, or that they were at least unoccupied by the Germans). In fact, the Canadians were not in possession of any of these craters. Further, Macintyre did not question reports that Canadian troops were dug in on the near lips of craters four and five, when they were actually in craters six and seven. Moreover, he passed messages to the 28th Battalion on the sixth that they were to counter attack and go “through craters 6-5 and 4 driving the enemy out of craters 3 and 2,” which, again, implies that he believed craters four through six were in Canadian hands. He mentioned in his report as well that troops from the 28th Battalion were consolidating craters four, five and six -- which was also incorrect. In retrospect, it seems obvious that Macintyre, even from his observation post with its view of the fighting, could not fully distinguish which craters were occupied by what army, and that by the end of his stay at the Voormezele OP (about 36 hours) he was as confused over the crater layout as everyone else.²⁰

The 4th and 5th Brigades, when they assumed control over the lines, simply accepted the situation as reported. Indeed, the 4th Brigade holds a minor share in the blame for the original mistake. Battalions from that brigade had battalion scouts in OPs and on reconnaissance patrols at the front as early as the night of April seventh, yet they too failed to recognize the error.²¹ Meanwhile records passed on to the 5th Brigade from the 4th Brigade on the night of April twelfth were dismal from an intelligence point of view, many being at least nine days old at the time of

²⁰ NAC, M.G. 30 E46 (Turner Papers) Vol. 2, Folder 10. “Report From Captain D.E. Macintyre, Staff Captain, 6th Canadian Inf. Brigade. to G.O.C., 2nd Canadian Division,” April 9, 1916.

²¹ NAC, M.G. 30 E46 (Turner Papers) Vol. 2, Folder 10. “Report on Action of 2nd. Cdn. Div. Scouts from April 6th to April 12th, 1916.”

transfer.²²

The 2nd Division's headquarters staff, including its intelligence officers, also misread the battle. Reports from the front were confused, and in the confusion divisional headquarters chose to believe the positive news that the Canadians were in possession of craters four and five over the negative news that they were not. Prisoners claiming that the Germans occupied craters two through five were dismissed by the division; after all, Canadians on the ground also claimed to be in those very craters.²³ Corps headquarters also misread these POW statements. In its April seventh Intelligence Summary the corps described the situation this way: The POWs said they occupied the craters as of midnight April sixth; however, "at present moment, noon April 7th., this is not the case and the change [in crater ownership] most probably took place after midnight;" that is, after the Germans were captured. Thus, divisional and corps headquarters rationalized away adverse POW statements.²⁴ An immediate investigation to clear up matters was not counselled, for both headquarters believed all was in order.

The most inexplicable intelligence blunder made by the Canadians was their failure to properly read the aerial photographs taken on April first and eighth.

²² NAC, R.G. 9 III C3, Vol. 4098, Folder 44, File 1. 4th Brigade to 2nd Division listing the documents handed over to, and signed for by, the 5th Brigade upon the latter's assuming command of the line, April 12, 1916. Seventeen documents were signed for in total: the 8th British Brigade's "handing over notes," a corrected version of the 3rd British Division's Defence Scheme, one copy each of the 9th and 8th British Brigades' Defence Scheme, one copy of the Voormezele Defence Scheme, the 9th British Brigade's notes to the 52nd British Infantry Brigade, a map of the Convent Lane Trench, a map of 5th Corps' Defended Area, a map of grenade stores, a letter regarding mines, Dispositions Right and Left Sectors, a sniping post map, a sketch of gas arrangements, information regarding enemy mining activity, a letter regarding O.C. Voormezele, the 17th British Division's S. of I. [Summaries of Information?] with sketches of The Mound (which of course had been leveled by the time the Canadians arrived), and a trench map (no date listed).

²³ NAC, R.G. 9 III C1, Vol. 3842, Folder 42, File 5-6. Report April 7, 1916. Repeated in the Divisional Intelligence Summary of April 7, 1916. See R.G. 9 III C1, Vol. 3835, Folder 25, File 4.

²⁴ NAC, M.G. 30 E61 (Mitchell Papers) Vol. 7, Folder 33. Canadian Corps Summary of Intelligence, April 7, 1916.

Corps, division, and brigade headquarters all had copies. Even a cursory glance at the photographs by a trench neophyte should have revealed the extent of the Canadian error. Macintyre recorded after the war that the new trenches dug around craters four and five by the Germans were mistaken for those dug by Canadian troops, while “the ineffectual ditches” scratched into the earth around craters six and seven were overlooked.²⁵ Furthermore, descriptions of the craters reaching the various headquarters from the front should have twigged the idea that something was amiss, as crater descriptions did not always mesh with the photographs. The comments by Major Styles and Captain Macintyre given earlier offer two cases in point. Craters two through five were massive holes that dwarfed craters six and seven mistaken by the Canadians for craters four and five.²⁶ Reports that the Canadians occupied craters half-filled with water should have been enough evidence to warrant investigation, as the photographs clearly showed that the larger craters were dry.²⁷ Macintyre’s lament that few officers were familiar with photographic interpretation, and therefore misread the photographs, seems a poor excuse.

By the eleventh of April, doubts were creeping into the minds of those at corps headquarters as to the veracity of the situation in the craters. To learn the true condition at the front, Captain S.A. Vernon, a British Intelligence Corps officer attached to the Canadian Corps, went forward to view the field. He was accompanied by a staff officer from the 5th Brigade, and the two went forward in

²⁵ NAC, M.G. 30 E241 (Macintyre Papers) Vol. 2. Macintyre’s monograph: “Men of Valour.” Chapter: “The Fight for the Craters.”

²⁶ NAC, R.G. 9 III D1, Vol. 4694, Folder 55, File 5. Captain Bidwell’s report, no date. Also R.G. 24, Vol. 1891, Folder 107. 18th Battalion to 4th Brigade April 9, 1916.

²⁷ Captain Bidwell, of the 28th Battalion, for example, reported that the occupied craters “are filled in the centre with pools of water . . .”, R.G. 24, Vol. 1891, Folder 107. Bidwell’s report.

order to come to some clear conclusions as to who held what craters.²⁸ Vernon concluded that craters two and three were “positively held by the enemy,” that crater two was “strongly defended and the garrison well dug in,” and that crater three appeared “to be held all around the rims as sniping is done from all sides.” As for crater four he noted:

This is in our hands and is approached through Crater No. 5 by a ruined shell wrecked trench along which one has to crawl on hands and knees and it is constantly sniped at and constantly under observation by enemy by flares. The crater itself is deep about 40 yards across and affords much better protection than No. 5. Its rims are higher but the Germans so dominate it from their trench in front that our garrison has to keep their heads down; the rims are constantly swept by rifle and M.G. fire. It is built up with some works on the inside facing the enemy and garrisoned by an officer, men and machine gun.

Regarding crater five he said:

This is in our hands and is a shallow crater about 40 yds across; the rims are flat and not high and do not dominate the enemy's new line as to elevation. This crater has no protection from enemy's fire except on the front side (inside) no trenches or paradoss exist on the rear (north) side, and this side is not occupied by our troops as it is constantly exposed to rifle and M.G. fire.²⁹

Vernon was wrong.³⁰ His mistake began when he assumed that his guide to the front correctly led him and the 5th Brigade staff officer to crater five, the point at

²⁸ I did not learn who the 5th Brigade staff officer was, perhaps it was the staff captain(I).

²⁹ NAC, R.G. 9 III C1, Vol. 3842, Folder 42, File 5-6. “Canadian Corps. Reconnaissance of St. Eloi Craters and Position by Lieut. S.A. Vernon - Intelligence Corps,” night of April 11-12, 1916.

³⁰ His error did not injure his reputation in the eyes of General Currie. In 1919 Currie recommended this officer for the D.S.O, and failing that felt the O.B.E. would be appropriate. Currie wrote: “his services as an officer of the Intelligence Branch have been very valuable to me, and I consider are worthy of some recognition. NAC, M.G. 30 E100 (Currie Papers) Vol. 38, File 172. Currie to Military Secretary, GHQ, June 12, 1919.

which he thought he began his reconnaissance.³¹ It was not crater five, but crater six, and Vernon should not have assumed his guide knew the front -- after all, it was Vernon's task to determine what the true situation was, not to accept what was already believed. As it turned out, the Canadians did not discover the true extent of their error until the sixteenth when aerial photographs confirmed a reconnaissance report by Major J.A. Ross and Lieutenant C.G. Greenshields who claimed after their patrol during the night of April fourteenth that the Germans held craters two through five.³²

In a more positive vein, the Canadians learned from the debacle. The 2nd Division, in an April twelfth report on the fighting (written before the fighting had ended and the true extent of the error had come to light) made fourteen worthy recommendations; several concern intelligence collection and its importance to command and control. It is worth quoting those particular lessons in full, for they show a maturation of thought in how intelligence contributes to an operation and to success on the field. They also show how tactics and decisions are limited by the information available. They are:

2. That information must be sent in early and often by subordinates. Negative information would often have been of the utmost value. Without information, battalion and higher commanders are groping in the dark.

3. The information sent in was not invariably correct. On two occasions parties were withdrawn from certain points, but no report to that effect was made for several hours. Parties must never be withdrawn without reference to competent authority, and all cases of withdrawal or advance must invariably be reported forthwith. Without such information it is impossible to obtain cooperation from all available sources.

³¹ NAC, R.G. 9 III C1, Vol. 3842, Folder 42, File 5-6. Alderson to 2nd Army, April 18, 1916.

³² NAC, R.G. 9 III C1, Vol. 3842, Folder 42, Files 5-6. "Reconnaissance Report. St. Eloi Crater Positions," for the night of April 14-15, 1916; F.C. Fetherstonhaugh, ed., *The 24th Battalion, C.E.F. Victoria Rifles of Canada 1914 - 1919* (Montreal: Gazette Printing Company, 1930), 48, 159-160.

5. ...When sending out a detachment every effort should be made to give it telephone communication to the rear...In cases where communication was kept up with such detachments information obtained was often invaluable.

6. Battalion and company commanders should have someone at their elbow constantly reminding them to send in news. A nil report is better than no report.

9. ...Similarly all officers and N.C.Os of outgoing units should do everything in their power to ensure that their successors understand what work is most needful.

11. Carefully prepared plans to meet any emergency must be pre-arranged. This applies to all officers and all N.C.Os in charge of small parties...All commanders should have conceived plans to meet any emergency.

12. Orders to detachments must be very clear. Limitations, if any, should be clearly stated. Every detachment is posted or sent forward for a definite purpose. It should be made absolutely clear to that detachment what its task is; and it should exhaust all means of clearing up the situation, and achieving the task allotted to it. The more clearly the task is explained, and the more clearly it is understood how that small task fits in with the larger scheme in hand, the more intelligently will the work be performed.

13. The situation was one in which greater value might have been obtained from Brigade and Battalion scouts. These have worked consistently well during the winter, and it was hoped that they would have cleared up the situation for us more rapidly than was the case. The absence of reliable information was one of the greatest obstacles to the success of the enterprise, and improvement in this direction will have to be made in future.³³

Regarding lesson nine, it is further confirmation of arguments made in Chapter Three concerning the value of a relief for gaining intelligence. Lessons six and thirteen are particularly poignant considering the 6th Brigade entered the lines on April third short three of its battalion intelligence officers. Lessons eleven and twelve state the need for pre-planning to meet "any emergency" (obviously good intelligence is a prerequisite). Interestingly, there was no mention in the lessons of the need for a divisional intelligence section able to zoom to the front to clarify

³³ NAC, M.G. 30 E46 (Turner Papers) Vol. 1, Folder 9. Memorandum from 2nd Division to subordinate commands, April 12, 1916.

events on the division's behalf even though, as lesson thirteen states: "The absence of reliable information was one of the greatest obstacles to the success of the enterprise."

At St. Eloi the Canadians made numerous errors and poor decisions. Errors were compounded onto errors, as intelligence officers and others assumed unsubstantiated information was correct. On April sixteenth, once the Canadians realized the enormity of their error, buck passing commenced, as officers were not willing to accept blame. Some of this can be seen in lesson number thirteen above, where the scouts are blamed for the persistent failure to clarify the situation. This is unfair, for it was not just the scouts who failed to identify the error. In fact, it was not solely the absence of information that caused the misunderstanding, but rather it was the misreading of evidence that was available, and all levels of command were at fault there. General Ketchen, however, refused to be the army's scapegoat. He wrote, "My Brigade, however, was 'thrown' at a moment's notice into an absolutely unknown portion of the line, without opportunity of looking it over and under the most adverse conditions conceivable." He reminded higher command that the British before him had also mistakenly claimed to have occupied certain craters when in fact they had not. He did not mention in this letter to corps headquarters, though, the fact that he let battalions enter the lines without their intelligence officers.³⁴ General Alderson, the corps commander, was clear on whom to blame: "the forwarding of inaccurate information during this period," he wrote in his report to the 2nd Army, "must rest with the 2nd Canadian Division." It is difficult to entirely accept his judgment considering the interpretive errors made by staff at corps headquarters. Alderson's statement that "I know that both Divisional and Brigade Staff Officers have tried to clear up the situation and I have

³⁴ NAC, R.G. 9 III D1, Vol. 4688, Folder 42, File 14. Ketchen to 2nd Division, April 18, 1916.

sent officers of my own staff down for the same purpose...I and my B.G.G.S. [Brigadier General, General Staff] have visited the Division and Advanced Brigade H.Q. daily and satisfied myself that the situation was exactly as represented," casts doubt on his judgment that the 2nd Division was solely responsible for the error.³⁵ If he really was "satisfied...that the situation was exactly as represented" then he was equally to blame for any misunderstanding. However one looks at it, St. Eloi was an intelligence failure by all parties concerned.

By June 1916, the 2nd Canadian Division had learned a great deal since it first arrived in the trenches nine months earlier. That month, and no doubt after much soul searching and self examination, the division reissued a British document titled "Principal Points to be Attended to in Making Preliminary Arrangements" (Principal Points). The British had first distributed this document to the corps after the Battle of Loos in September 1915. It offered a step by step approach to defeating an entrenched enemy. One sentence from the "Principal Points" summarizes its content: "Each attack must be thought out in every detail, and all arrangements be worked out beforehand as completely as possible." Little wonder, then, that the need for reconnaissance and the collection and study of intelligence were the first two items discussed. From the massing and study of information that such detailed planning demanded, "the exact position of every man in our system of trenches prior to the assault [could] be worked out and prepared." Artillery time tables could be "drawn up with great care" beforehand, as could the movements of the infantry, the various headquarters units, and the signalling stations.³⁶ The "Principal Points," in effect, reaffirmed what was emerging as the Canadians' preferred approach for defeating enemy trench works -- a mammoth accretion of

³⁵ NAC, R.G. 9 III C1, Vol. 3842, Folder 42, Files 5 -6. Alderson to 2nd Army, April 18, 1916.

³⁶ NAC, R.G. 9 III C3, Vol. 4122, Folder 4, File 2. "Principal Points to Be Attended to in Making Preliminary Arrangements," first issued in September 1915, later reissued by the 2nd Canadian Division on June 5, 1916.

intelligence followed by elaborate pre-planning in which key decisions were made in advance in order to diminish battlefield confusion and loss of control during the assault.

Lessons learned notwithstanding, April had been a dire month for the Canadians; June began equally bleakly. The corps started the month without General Alderson; he took the fall for the St. Eloi debacle. His replacement was Lieutenant-General Julian Byng. Byng had commanded the 17th British Corps prior to his joining the Canadians, having also served in the Dardanelles campaign, and with the British cavalry. He was experienced leading troops in combat, and was a thorough believer in detailed planning. Byng was with the Canadian Corps only five days when the Canadians found themselves once more in the thick of fighting. In the morning hours of June second, the Germans launched a devastating attack on the position held by the 3rd Canadian Division. Their goal was to drive the Canadians from the last vestige of the Ypres ridge still in Allied hands. Tactically, the position was important because it afforded the Canadians a good view of the German lines. If the ridge fell into German hands the situation would be reversed, with the Germans occupying the commanding terrain. Operationally the ground was important because a German occupation of the ridge would threaten the rear of the Allied line, possibly to the extent that a wider withdrawal might be necessary.³⁷ At 8:30 in the morning the Germans opened a vicious four hour bombardment, described by some of the men present as the most intensive shelling suffered by British troops to date.³⁸ Canadian communications to

³⁷ James Edmonds, *Military Operations, France and Belgium, 1916*, Vol. 1 (London: Macmillan and Co., Limited, 1932), 230.

³⁸ D.J. Goodspeed, "Prelude to the Somme: Mount Sorrel, June, 1916," eds. Michael Cross and Robert Bothwell, *Policy by Other Means: Essays in Honour of C.P. Stacey* (Toronto: Clarke, Irwin and Company Ltd., 1972), 150.

the forward positions were knocked out.³⁹ By 2:00 p.m. German troops had overrun the 3rd Canadian Division's forward line, and occupied the important high points along the ridge. A hastily organized counter attack by units under Currie's command failed to dislodge the German defenders. The supporting artillery was of little help during this counter attack, as the location of the new German line remained a mystery, a condition that General Currie warned against when he asked that the counter attack be postponed until the situation became clearer. Undaunted by the failure of the original counter attack, and determined to win back the lost ground, Byng granted Currie the necessary time to prepare a thorough plan of action to recapture the ridge. Poor weather intervened, and delayed the assault until the thirteenth.⁴⁰

The German attack on June second was not entirely unexpected by the Canadians. Preparations had been apparent for some four weeks. The British 2nd Army had warned the Canadian Corps during the first week of May that German prisoners were talking about a pending German offensive in the area.⁴¹ Towards the end of the month, infantry patrols reported that German troops were pushing saps forward on various parts of the front, and that by month's end these saps were joined to form a new lateral trench fifty yards closer to the Canadian location.⁴² Meanwhile, the RFC had discovered German practice trenches behind the lines that

³⁹ Edmonds, *Military Operations, 1916*, Vol. 1, 232; Nicholson, *Official History*, 149.

⁴⁰ NAC, M.G. 30 E100 (Currie Papers) Vol. 52. Diary, Photocopy of, June 2, 1916. Daniel Dancocks, *Sir Arthur Currie. A Biography* (Toronto: Methuen, 1985), 70-71. Also Hugh M. Urquhart, *Arthur Currie. The Biography of a Great Canadian* (Toronto: J.M. Dent & Sons (Canada Limited)), 129; John Swettenham, *To Seize the Victory. The Canadian Corps in World War I* (Toronto: The Ryerson Press, 1965), 110. Nicholson, *Official History*, 147-154. D.J. Goodspeed, "Prelude to the Somme," 148-151.

⁴¹ Urquhart, *Arthur Currie*, 123.

⁴² Saps, or approach trenches, were trenches dug into no man's land, and towards enemy positions, from friendly trench lines. These saps were then connected at their sap heads by a lateral trench. By doing this a force could advance its trench lines closer to the enemy without unduly exposing itself to enemy fire.

looked remarkably similar to certain Canadian positions. The Canadians also knew that the Germans had placed large calibre trench mortars and other guns closer to the front, and this, along with the prodigious increase in shelling and German aerial observation, all pointed to some German action in the making. The night before the Germans attacked there was one additional warning that was ultimately dismissed; there was a seven hour pause in the German shelling program. At first this caused the Canadians some concern, for any change in enemy habits was viewed with suspicion. (The Germans used the pause to cut gaps in the wire). When the shelling recommenced the Canadian command relaxed somewhat, feeling that all was back to normal.⁴³ The German work parties visiting the wire went undetected. The main difficulty for the Canadian defenders was not in recognizing the signs of an impending assault, but in predicting the moment of attack -- always a difficult, if not impossible, task. Since they saw no abnormal German troop movements, an immediate assault was not thought likely.⁴⁴ The Canadians remained suspicious enough, however, that on the morning of June second, Major-General M.S. Mercer, commander of the 3rd Canadian Division, and Brigadier-General V.A.S. Williams, commander of the 8th Canadian Brigade, went forward with some other officers to conduct a reconnaissance of the front. They, along with hundreds of Canadian troops manning the forward trenches, were caught in the German storm of steel. Mercer, the highest ranking Canadian to lose his life in the war, was killed. Williams, the highest ranking Canadian captured during the war, was wounded and eventually taken prisoner. The day went downhill from there.

⁴³ Dancocks, *Sir Arthur Currie*, 69. Nicholson, *Official History*, 148. Edmonds, *Military Operations, 1916*, Vol. 1, 229-230.

⁴⁴ The RFC had been grounded for several days prior to June second due to poor weather. Even so, they would not likely have seen any unusual movement, as the Germans relied on the troops they had on hand. Apart from some additional artillery, no new German troops were brought up to assist.

The Canadian counter attack eleven days later was another story, and was the Canadian Corps' first major set-piece attack, and was an enormous success.⁴⁵ As mentioned, Major-General Currie's 1st Division was given the task of retaking the lost ground. Currie, as we have seen, was a stickler for details, and the plans for the counter attack bore his mark, and reflected his experiences and the lessons espoused in the "Principal Points to be Attended to in Making Preliminary Arrangements" discussed earlier.

It was Currie's intention to let the artillery play the winning role by having it smash specific obstacles and strong points that otherwise would have menaced the advancing infantry. The infantry, in turn, would then occupy the ground conquered by the artillery. The battle would be expensive in shells, but hopefully not in men's lives. Before launching this plan the Canadians carried out a tremendous intelligence effort. Enemy troop identifications were meticulously collected. Intelligence and other officers compared tactical details gathered by ground troops to aerial photographs, and used them to update maps. Scout officers made careful reconnaissances and "located the German line with great exactness as was proved eventually by aeroplane photographs when the weather permitted aeroplanes to work."⁴⁶ Lists of targets, compiled from information gathered by photographic clerks, infantry patrols, and aerial and ground observers, reached the gunners on a daily basis. Target information included details on German assembly areas, dugouts, tramways, routes of approach, dumps, command posts, observation posts, machine gun emplacements, and telephone exchanges. Intelligence officers prepared annotated drawings of specific buildings, along with

⁴⁵ It might be more accurate to say the counter attack was the corps' first partial set-piece attack, for the rolling barrage and an effective counter battery element were missing. This was due to limitations in both gunnery technique and counter battery intelligence sources at the time.

⁴⁶ NAC, R.G. 9 III C1, Vol. 3842, Folder 43, File 1, 1a, 1b. "Report on the Operations of the 1st Canadian Division, From June 2nd to June 14th 1916."

descriptions of their probable use and troop contents. Divisional staff officers also prepared a map showing the location of specific targets to be taken out by the artillery and mortars.

The night before the assault the artillery carried out an “intense bombardment of the German positions.” “This bombardment was reported to be very accurate by the Scout Officers of the Battalions in the line” who were watching it.⁴⁷ The artillery tried to eliminate those German defences remaining hidden and undetected before Zero by saturating with shells those trenches “commanding our [infantry] advance.”⁴⁸ The “Report on Operations of Artillery of Canadian Corps -- June 2nd to June 14th 1916,” said this preliminary bombardment was so successful

that but little resistance was met with [by the advancing troops]; no machine gun or rifle fire from HILL 60 and the SNOUT; only one [enemy] machine gun apparently remained in action in the position and this jammed. [Canadian] Casualties were slight and mostly due to hostile shell fire; enemy’s trenches for the most part completely destroyed and the surviving defenders demoralized. The whole of the hill is one brown bog and it is impossible to recognize its former features.⁴⁹

The intelligence collected had allowed the gunners to pound the Germans into submission. The artillery blasted the Germans so extensively that the infantry regained in about an hour’s time nearly all the ground lost on the second of June. The success of the artillery plan did not suffer for lack of information.

Trench mortars contributed to the pre-battle bombardment. The 1st Division

⁴⁷ NAC, R.G. 9 III C1, Vol. 3842, Folder 43, File 1, 1a, 1b. “Report on the Operations of the 1st Canadian Division From June 2nd to June 14th 1916.”

⁴⁸ NAC, M.G. 30 E6 (Burstall Papers) Vol. 2, Folder 10. “Canadian Corps R.A. - - Operation Order No. 7,” June 10, 1916; R.G. 9 III C1, Vol. 3832, Folder 15, File 1-4. “List of Suitable Artillery Targets in Enemy’s Lines Opposite Mount Sorrel, Observatory Ridge, Sanctuary Wood and Hooge,” June 8, 1916; R.G. 9 III D1, Vol. 4688, Folder 40, File 16. Patrol Report by Lt. Harrower and Scout Bole to 2nd Brigade, June 4, 1916.

⁴⁹ NAC, M.G. 30 E6 (Burstall Papers) Vol. 2, Folder 10. “Report on Operations of Artillery of Canadian Corps - June 2nd to June 14th 1916.”

reported that “Stokes Guns [mortars] were used with good effect in destroying, or completing the destruction of, the German Machine Gun Emplacements and Strong Points in and about their front line.”⁵⁰ Indeed, along one portion of the front, trench mortars suppressed enemy machine gun and rifle fire to such an extent that consolidation parties easily made their way to their objectives “with but few casualties.”⁵¹ Knowing the location of enemy machine guns also allowed the trench mortars to lay down a smoke screen across their front to blind them. “The result produced was reported to have been most successful.”⁵²

Planners also carefully prepared the infantry’s part in the assault using the latest intelligence. Assaulting troops knew where to go, and when to proceed, as objectives had been clearly laid out in operation orders. Rehearsals over training grounds resembling the area to be attacked further ensured that the men knew their tasks. The fact that artillery and trench mortars had smashed nearly all resistance made their advance all the easier. Consolidation parties also practiced their role, and so knew how to reach their objectives and strengthen the new line before the expected German counter attacks materialized. Scouts kept these parties in touch with the advancing troops, and guided them forward at the right time and place. Machine gunners, too, knew their tasks. Machine guns from the 1st Canadian Motor Machine Gun Brigade and the 3rd Division’s Motor Machine Gun Battery, all under the orders of Lieutenant Colonel Raymond Brutinel, provided the infantry with covering and supporting fire. These guns fired at specific targets decided

⁵⁰ NAC, R.G. 9 III C1, Vol. 3842, Folder 43, File 1, 1a, 1b. “Report on the Operations of the 1st Canadian Division From June 2nd to June 14th 1916.”

⁵¹ NAC, R.G. 9 III C1, Vol. 4688, Folder 40, File 16. “2nd Canadian Infantry Brigade Describing the Operations in the Ypres Salient From 2nd June to June 14th 1916.”

⁵² NAC, R.G. 9 III D1, Vol. 4676, Folder 5, File 5. Narrative by Brigadier General G.S. Tuxford regarding Operations at Mount Sorrel.

upon in conjunction with the infantry.⁵³ They also applied intermittent enfilade fire against the German front and support lines. Brutinel gave detailed instructions for regulating their fire, while a system of light signals, worked out with the infantry they supported, assured that "a sudden application of fire" was available when required. The system worked well. For example, at "9.15 a.m. the Germans were reported massing in front of MOUNT SORRELL [sic] and the M.G. [Machine Gun] opened fire immediately with good effect."⁵⁴

Experience had shown that the Germans would not sit idly by while their position was overrun, but would answer with what were characteristically swift and hard-hitting counter attacks. Knowing this the Canadians, through their study of available intelligence on German billeting areas, roads, and habits, prepared march tables for the German reserves in the area -- that is, estimates were made on how long it would take German counter attacking forces to reach the battlefield and by what likely routes. At appropriate times in the battle the gunners shelled these routes in order to break German counter attacks before they could fully materialize. Indeed, at least one counter attack brewed-up at the time and place predicted by the march tables, and so received the full weight of a concentrated artillery barrage designated for that location.⁵⁵

Communications -- always vital for the transmission of intelligence -- played an important role in maintaining command flexibility during the attack. This

⁵³ NAC, R.G. 9 III C1, Vol. 3842, Folder 43, File 1, 1a, 1b. "Report on the Operations of the 1st Canadian Division From June 2nd to June 14th 1916;" R.G. 9 III C3, Vol. 4011, Folder 16, File 1. Report by Lieutenant Colonel Macphail, C.R.E., 1st Division, June 8, 1916; R.G. 9 III D1, Vol. 4688, Folder 40, File 15. "2nd Canadian Infantry Brigade Operation Order No. 100, June 11th 1916;" Swettenham, *To Seize the Victory*, 112.

⁵⁴ NAC, R.G. 9 III C3, Vol. 4011, Folder 16, File 1. Brutinel's "1st C.M.M.G. Bde Report on Operations Extending from the 2nd to the 14th June 1916."

⁵⁵ Goodspeed, "Prelude to the Somme," 157; Nicholson, *Official History*, 154; Nicholson, *Gunners*, 255; Edmonds, *Military Operations France and Belgium, 1916, Vol. 1*, 242.

was especially important for effective artillery opportunity fire. The gunners had several ways of keeping in touch with events at the front. Telephones connected infantry brigades to their supporting guns, and were used to call for support as needed. In addition, the advancing infantry carried variously coloured flares to mark their progress. The infantry fired white flares, for example, when they took their first objective, and red flares when they captured their final objectives. More important for the artillery were the green flares, these were fired by the attacking troops when their advance stalled due to enemy action. Upon seeing these, the artillery group commander whose guns covered that portion of front, turned his 'battery of opportunity' onto the area in question.⁵⁶ In addition to flares, the infantry carried coloured flags to mark their progress: yellow and black by those on the right flank, red by those in the centre and on the left. What is more, the infantry carried rockets that when fired exploded into a red star-burst. They were to use these only if the telephone system broke down, and only if the enemy was seen massing for a counter attack. Each artillery group established a lookout station to watch for these rockets, and plotted their positions on maps using their exact map location. The lookout man, who was equipped with a director for taking bearings, was then able to provide precise directions for the gunners. As the divisional artillery operation order stated:

As soon as a rocket goes up, the look out man will report to his Group H.Q. by telephone the direction, Group H.Qs. will at once communicate these directions to each other and to this [the 1st Divisional artillery] H.Q.

When Group H.Qs. get an intersection of two bearings they will at once open a Barrage on the indicated area, -- provided it is on their allotted zone...

⁵⁶ Throughout the attack each artillery group held "one battery in hand to deal with any contingency that may arise." See, NAC, M.G. 30 E6 (Burstall Papers) Vol. 2, Folder 10. "Report on Operations of Artillery of Canadian Corps -- June 2nd to June 14th 1916."

In order to simplify communications look out stations may be at Battery positions or O.Ps, but they must be so sited that they will see any rocket liberated on the front of the attack

Neighbouring Divisions are making similar arrangements and bearings should be sent to neighbouring Artillery Groups.⁵⁷

In the meantime, tactical observers -- essentially FOOs -- affiliated with each artillery group watched the attack and reported the progress of the advancing infantry to gunners in the rear. They also called in other opportunity targets such as massing enemy troops, troublesome machine guns, and other points of resistance. Their task was made easier by the fact that the gunners had a good understanding of where the infantry were supposed to be in the first place, for prior to the attack each artillery group commander had learned from the infantry brigade commander their guns were supporting the details of the infantry's part in the attack. The tactical observers, in addition to using "normal communications" (visual signals, flags, runners, and so on), used "special telephone equipment" (probably a Fullerphone or a Power Buzzer), and were accompanied by a "party of telephonists." They could then send information to their group headquarters through normal means, or through the receiving stations equipped with "The special instrument [necessary] for receiving messages" from the special telephones.⁵⁸ Operation Order No. 23 described the arrangement this way:

⁵⁷ NAC, M.G. 30 E6 (Burstall Papers) Vol. 2, Folder 10. "Operation Order No. 23. By Brigadier-General H. C. Thacker, C.M.G., C.R.A., 1st Canadian Division," June 11, 1916. See also R.G. 9 III C3, Vol. 4011, Folder 16, File 3.

⁵⁸ Ibid. Fullerphones were a combination telephone/telegraph transmitter/receiver that offered protection against German phone-tapping. The "invention made possible [the] transmission of very weak morse signals which could not be picked up by the enemy and, secondly, once the line had been cleared...could be used for normal telephone speech, though this, of course, was not secure." Power Buzzers used earth induction to carry messages in Morse Code. They also offered protection against enemy interception. See Guy Hartcup, *The War of Invention: Scientific Developments, 1914 - 1918* (London: Brassey's Defence Publishers, 1988), 78.

The special instrument for receiving messages from Tactical Observers will be installed at BATTERSEA FARM in a dugout which is being constructed by MacLaren's [artillery] Group.⁵⁹

Lieutenant Macfarlane C. E. i/c R. A. [Canadian Engineers in command of Royal Artillery] Signals will arrange for this receiving station being connected up with the buried cable [of the wider communication grid].

MacLaren's Group and Creelmar's [Artillery] Group will each furnish one telephonist at BATTERSEA FARM for transmitting messages (received on the special instrument) to Groups.

Signals Canadian Corps will arrange for the installation of the receiving instrument -- and will provide operators.

The receiving station will be controlled by O.C. [Officer Commanding] MacLaren's Group....⁶⁰

These arrangements added to overall command flexibility.

Liaison officers, and aerial observers flying overhead, increased the agility of the artillery support even more. The various overlapping systems for relaying news worked well. Certainly Brigadier-General George Tuxford, commanding one of the attacking infantry brigades, did not complain. He wrote in his after action report that: "Our artillery...gave every satisfaction. They were always keenly alert, and their response to calls for retaliation were always prompt and appeared to be effective."⁶¹

The infantry's communication arrangements were equally complex. We have already discussed how the men at the sharp edge used flags, telephones, flares, and rocket signals to keep the gunners informed. These same methods, of course, also kept rear area infantry commanders in touch with events transpiring at

⁵⁹ Tuxford's infantry brigade also had an advanced report centre at this farm, which no doubt eased the sharing of intelligence between the two service arms.

⁶⁰ NAC, M.G. 30 E6 (Burstall Papers) Vol. 2, Folder 10. "Operation Order No. 23. By Brigadier-General H. C. Thacker, C.M.G., C.R.A., 1st Canadian Division," June 11, 1916.

⁶¹ NAC, R.G. 9 III D1, Vol. 4676, Folder 5, File 5. Narrative by Brigadier General G.S. Tuxford regarding Operations at Mount Sorrel.

the front.⁶² Observers watching the action from brigade and battalion observation posts, upon seeing the various signals, called their respective headquarters on telephones to impart the news. Moreover, each assaulting battalion rushed signalmen forward during the advance to establish signal stations in the captured trenches. Telephones, visual signals, runners and pigeons were all on hand at these stations, thereby allowing the advancing troops to maintain contact with the rear. The 3rd Battalion had its telephone up and running within five minutes of securing its objectives.⁶³ German shelling, however, soon put most of these advanced telephones out of action, and so communication was mainly by runners, pigeons, and lamp signals. Unit commanders also sent patrols forward to locate the new Canadian and German lines. In this way scouts from the battalion scout sections, held in reserve for just such missions, gathered valuable information.⁶⁴ Despite all these efforts, however, the passing of news from the forward-most troops to battalion headquarters remained a slow process. Enemy action simply prevented information from being sent back in a timely manner, and this rendered real-time control by battalion commanders impossible. Pre-planning, however, lessened the need for their immediate hands-on control.

By comparison, the flow of information behind battalions was fairly quick and secure. Prior to zero, in an effort to shorten the distance that the information had to travel between the front battalions and their parent brigades, brigade signal officers established advanced report centres at points between brigade and battalion

⁶² Brigadier Tuxford concluded that "In some cases [flares] were not available owing to the carriers becoming casualties but in the main were useful in giving some idea as to progress made."

⁶³ Bill Rawling, "Communications in the Canadian Corps, 1915 - 1918: Wartime Technological Progress Revisited," *Canadian Military History* 3.2 (Autumn 1994): 9

⁶⁴ NAC, R.G. 9 III D1, Vol. 4676, Folder 5, File 5. Narrative by Brigadier General G.S. Tuxford regarding Operations at Mount Sorrel; R.G. 9 III C3, Vol. 4140, Folder 1, File 5. 29th Battalion report on work carried out by its scout section, June 5 - 14, 1916.

HQs. The signal officers, with parties of signallers, remained at these centres throughout the action, relaying news from the front as it arrived. Telephones, runners and lamp signals were all available for this purpose.⁶⁵ Telephones also connected the infantry to the gunners, and in the case of Tuxford's Brigade, information exchange was eased further by the fact that his brigade's advanced report centre was located in the same dug-out complex as the artillery receiving station mentioned earlier. With these arrangements in place, the two service arms could readily share information and, as we have seen, Tuxford was well pleased with the result.

Brigades also gathered information independent of that sent to them from the front. Brigade scouts and the staff captains(I) watched the action from brigade OPs, and reported their observations to brigade headquarters over telephone lines set up for that purpose. Staff officers, including the staff captains(I), also visited the front to learn about the state of affairs first hand, and provided brigade headquarters with valuable information. When combined with news arriving from other quarters, that collected by brigade scout sections kept brigade headquarters very much in tune with the fighting. Tuxford's own narrative of the battle offers evidence of this. It contains a breakdown of messages received at given times, and shows that brigade headquarters was always well in touch with events at the front. For example, at 2:10 a.m. (forty minutes after the launch of the infantry) we read: "It was reported that a red flare was seen on MOUNT SORREL one to the right and one to the left of MOUNT SORREL, whilst 3 green flares were reported to be seen

⁶⁵ R.G. 9 III D1, Vol. 4688, Folder 40, File 15. "2nd Canadian Infantry Brigade Operation Order No. 100, June 11th 1916." The British and Canadians were now using armoured telephone cable, buried six feet deep. At Mount Sorrel it connected the advanced report centres to brigade and battalion headquarters, and it withstood the assault well. In Tuxford's Brigade the connection between the advanced report centre and the brigade HQ was only broken once by German action. Forward to battalions the cable was severed a number of times, but repaired. Laddered lines laid on the ground were also used, but were quickly put out of action. Wireless sets were not available to brigades at this time.

to the left of MOUNT SORREL.” Later he reported that at 2:23 a.m. the sighting of white and red flares. Later still, after many more messages, he says that at 3:10 a.m. a runner arrived at the advanced report centre from the 16th Battalion

Stating that they had gained their final objective, were extending their position and had commenced to consolidate. At the same time a message was received from the 13th Battalion that they were temporarily held up and asking for supports. This was at once passed to the 4th Supporting Battalion, and a reply received from the O.C. 4th Bn. [Battalion] that a company had already been sent up.

At 9:00 a.m.: “O. C. [Officer Commanding] 1st Battalion reports to 2nd Bde [Brigade]. ‘Germans massing opposite MOUNT SORREL.’ All our artillery warned to Stand-by and runners despatched from 4th Battalion to warn 13th Bn. and 16th.’⁶⁶

On the other hand, counter battery fire was inadequate throughout the operation. Most German batteries went undetected prior to and during the assault, and so continued to shell and harass the attacking troops. The problem was that methods for securing counter battery intelligence -- sound ranging and flash spotting, for example -- were not yet sufficiently developed to be of use in locating hidden German batteries, while locating camouflaged gun emplacements from the air and from aerial photographs remained a difficult task. At the same time, the science of gunnery was such that gunners continued to face difficulties firing at unobserved targets and from maps. In practice this meant that German artillery relentlessly pounded the advancing infantry as they tried to capture and consolidate ground, while signallers, gallantly struggling to maintain some form of communications from the captured ground to the rear, were constantly frustrated.⁶⁷ Tuxford reported how one consolidation team could not reach its objective because

⁶⁶ NAC, R.G. 9 III D1, Vol. 4676, Folder 5, File 5. Narrative by Brigadier General G.S. Tuxford regarding Operations at Mount Sorrel.

⁶⁷ D.J. Goodspeed, “Prelude to the Somme,” 156 - 159.

of enemy shelling, while “Great difficulty was experienced in getting up supplies of material and ammunition on account of the heavy artillery barrages, which at times made progress impossible.” Stretcher bearers also found their work interfered with.⁶⁸

For the most part, thanks to a well prepared and flexible plan, the Canadian assault on June thirteenth was a complete success. Prior planning told the troops what their roles were, and let the artillery smash targets during the preliminary bombardment. Throughout the battle, the communications system carried enough intelligence for the artillery to engage any opportunity targets arising. “The accuracy and flexibility of the artillery fire plan” was such that most of the German defenders were “cowed...before the assault” even began.⁶⁹ The Canadian official history states that it was almost possible for the Canadians to advance to their objectives with rifles slung over their shoulders.⁷⁰ Currie’s goal to win with shells and not lives paid off handsomely.⁷¹ The accuracy of the intelligence was important here, for it allowed gunners to hit targets of real value. As Currie later remarked, the victory was “almost too easy.”⁷²

Mount Sorrel restored much of the shine to the tarnished Canadian intelligence system. Given sufficient time, the intelligence organization was capable of securing remarkably accurate information. Extremely complex plans that helped reduce battlefield confusion and the loss of control were built on this information. Intelligence was not the sole ingredient for success, of course, but it certainly made victory easier, as Mount Sorrel suggested. Conversely, the lack of intelligence, or

⁶⁸ NAC, R.G. 9 III D1, Vol. 4676, Folder 5, File 5. Narrative by Brigadier General G.S. Tuxford regarding Operations at Mount Sorrel.

⁶⁹ D.J. Goodspeed, “Prelude to the Somme,” 158.

⁷⁰ Nicholson, *Official History*, 153.

⁷¹ Canadian Corps losses between June 1 - 7, 1916 were 5,838, and between June 8 - 15, were 2,630. See Rawling, *Surviving Trench Warfare*, Appendix B, 239.

⁷² Currie quoted in Dancocks, *Sir Arthur Currie*, 72.

its misreading, contributed to defeat, as evidenced at the St. Eloi Craters. Fortunately for the Canadians, they realized the worth of intelligence, and its value in operational planning and execution, and so continued to develop this branch of the service in the weeks, months and years ahead.

CHAPTER SEVEN

THE SOMME: AUGUST - NOVEMBER 1916

The victory at Mount Sorrel restored Canadian confidence, but rather than resting on their laurels they looked for ways to improve. One area that came under scrutiny was intelligence work. It seemed obvious after Mount Sorrel that pre-planning, and the necessary study of intelligence this entailed, was a crucial factor in defeating entrenched positions. The wise use of intelligence at Mount Sorrel encouraged greater use of intelligence in the future, and ushered in a mini intelligence renaissance in the weeks prior to the corps' moving to the Somme in September 1916. The fighting at the Somme, though, was unlike any the Canadians had previously encountered, and all their preparation did not fully imbue them with the requisite skills necessary for waging such intense and protracted combat. Once in the lines, the intelligence system, like everything else, was put through the greatest test it had yet faced, with mixed results. By late November the Canadians had withdrawn from the Somme to lick their wounds. Over the winter months the corps reviewed its performance, and studied its failings. By the time it next saw major fighting in April 1917, it was ready. First, however, it had to survive the Somme.

To help spread the good news about intelligence, and to share ideas on how to improve procedures, Lieutenant Colonel Mitchell hosted on August ninth what was probably the first Canadian Corps corps-wide intelligence conference. Officers responsible for intelligence and serving with divisions, the artillery, the heavy artillery, infantry brigades, and the RFC squadron attached to the corps were asked

to attend. Tactical intelligence was front and centre, with the focus being on such areas as the organization and duties of battalion scouts, artillery - infantry intelligence cooperation, "Continuity of observation and Intelligence Duties in handing over at reliefs," and the use and distribution of aerial photographs. Mitchell "hoped that a free discussion of the forgoing [topics would] result in changes" to corps procedures, and increase efficiency in the intelligence organization. Through a sharing of ideas, knowledge, and concerns, Mitchell was striving for a system of standardized procedures, and improvements to intra-service cooperation and corps cohesion.¹ Unfortunately, no notes taken by participants during this conference were located, so it is difficult to gauge what long-term effect this meeting had on specific day-to-day intelligence developments in the corps. The fact that there was a corps-wide conference at all, however, speaks to the importance of intelligence work to the Canadians at this stage of the war. Furthermore, Mitchell's concern with tactical, battalion-level intelligence, and his interest in a cooperative, all-arms approach to intelligence gathering and dissemination, shows that he and the corps were struggling to find a new all-arms tactical solution to the trench deadlock. The Canadians were searching for more tactical flexibility, and Mitchell's interest in a cooperative, all-arms intelligence effort is a reflection of that desire. A more rapid sharing of information would give the supporting arms more opportunity to respond to the infantry's needs. It was his thinking about how intelligence could help with tactical development, more than any specific details that might have emerged from this conference, that makes it significant in the development of the Canadian Corps' intelligence system.

In addition to conferences, lectures proved a popular means of conveying to both officers and men the importance of intelligence to operations. One Canadian

¹ National Archives of Canada (NAC), Record Group (R.G.) 9 III C3, Vol. 4104, Folder 16, File 3. Memorandum calling for an intelligence conference, August 7, 1916.

Corps lecturer, for example, stated that “Our own operations are largely dependent on intelligence” concerning the enemy position, and that the value of even trivial scraps of information “may be very great.” Every officer and man could assist in gathering intelligence, noted the lecturer. “All ranks must be always alert to recognise and to promptly report everything which may be of use.”² Major J.L.R. Parsons, the 2nd Division’s senior intelligence officer, echoed these sentiments in an August seventh lecture to the 4th Brigades’ scouts, snipers and observers. From his address it is clear that gathering and studying intelligence were vital for success on the field. Battalions, he pointed out, were responsible for gathering most of the intelligence necessary for planning and, therefore, were the foundation upon which all other intelligence and planning lay. As such, battalions required well organized and trained intelligence sections. Parsons also addressed the complaints heard in the army about the amount of patrolling and raiding carried out. The ‘other ranks’ thought they were excessive, and gained little. Parsons simply countered by pointing out that knowing what units and what obstacles lay in front were “very important” for success, and to secure that information prisoners were needed, and that entailed raiding and patrolling.

Identification is urgently required by the Canadian Corps, and Second Army [recorded Parsons]; and G.H.Q. have actually written to know who is opposite the front you [scouts from the 4th Brigade] are going into to-morrow night. We must have a prisoner and we must know who is on our front whether it is a new or an old Division. This is an urgent matter, and all patrols must give this very careful consideration. In addition to the Raids themselves, the question of having patrols out is of the very greatest importance, it is a matter of security to your comrades in the front line and it helps to worry the Bosche [i.e., Germans].

² NAC, Manuscript Group (M.G.) 30 E61 (Mitchell Papers) Vol. 14, Folder 92 (1). “Outlines of Lectures on Intelligence. (For Regimental Officers) General Principles of Intelligence and its Relation to Other Branches of the Service,” July 1916.

He reminded the scouts of their importance during an advance, especially when the assaulting troops were stopped by enemy action. At those times "the scouts must go forward, reconnoitre the ground and tell us what the trouble is." The scouts were told that "There will probably be wire, there will certainly be machine guns and before any further advance can be made our artillery must know exactly where these things are, and it is the job of the battalion scouts to get that information." Once the assaulting troops had captured their objectives, "scouts and patrols should be pushed forward as soon as ever local conditions permit" in order to locate the new enemy line. He also reminded observers and front line scouts that "The life of your own comrades will often depend upon your being able to send back correct information to the artillery regarding hostile troops and works when an offensive is in progress." The value of intelligence, and the importance of scouting in gathering that information, was made plainly clear to all.³

In addition, lecturers discussed the latest intelligence gathering techniques. In July, an officer from the Canadian Corps gave a talk on how to interpret airplane photographs. Photographs were, of course, an important tool for uncovering secrets in the German lines. "It may be taken as a general rule," says the lecture notes, "that to the trained eye the whole hostile organization is visible except such things as Machine Guns, Trench Mortars and guns which have been dug in and covered over." Ground level intelligence sources filled in these blank spaces, and were important for completing the intelligence picture. Indeed, in order to get the most out of a photograph, the notes pointed out, "it is very necessary that the ground covered by the photograph be reasonably well known."⁴ Lecturers also

³ NAC, M.G. 30 E117 (Parsons Papers) Vol. 4, Folder 23. "Lecture by Major J.L.R. Parsons. General Staff, 2nd. Canadian Division. 7th August, 1916."

⁴ NAC, M.G. 30 E50 (Jones Papers) Folder 3. "Outlines of Lectures on Intelligence. (For Regimental Officers) Notes Regarding the Interpretation of Aeroplane Photographs," July 1916. Of great assistance in interpreting aerial photographs was the introduction in the summer of 1916 of the Stereoscope. This

discussed intelligence work in open warfare, and noted the need for increased speed in collecting and forwarding information under such conditions. In July, one lecturer observed that in fluid battles, with deep penetrations, the artillery would need to change positions more often, and support the infantry with less information than they were used to. He also noted that the RFC would likely do more observation and less photographic work, there being less time for taking, developing and studying photographs in a moving battle. Further, he pointed out that regimental officers would have to take on more responsibility in battle. In other words, this lecturer, like Mitchell with his corps-wide conference, was bringing home the idea that the intelligence environment was changing due to new tactical realities, and that greater flexibility in the collection and dissemination of news was required if the Canadians were to succeed in battle.⁵

The standardization of intelligence procedures begun in 1915, continued in 1916. For example, in August the 1st Canadian Division released its intelligence policy statement titled "Instructions regarding Intelligence." This appears to be one of the earliest, if not the earliest, comprehensive intelligence policy papers produced by the Canadians. These "Instructions" did not discuss techniques for gathering intelligence by front line units -- that was left to training manuals and other guidelines -- but concentrated on individual and unit responsibilities and general requirements. The necessity of forwarding information, the intelligence responsibilities of brigades, battalions and forward observation officers, the tasks of scouts and observers during operations, the examination of captured enemy equipment, and the intelligence organization of brigades and battalions in the

device gave photographs a three dimensional look, making it far easier to identify features, to pick out phony installations and camouflaged sites.

⁵ NAC, M.G. 30 E61 (Mitchell Papers) Vol. 14, Folder 92 (1). "Outlines of Lectures on Intelligence. (For Regimental Officers) General Principles of Intelligence and its Relation to Other Branches of the Service," July 1916. Note: the lecturer referred to in this paragraph was not identified. It might have been Mitchell.

division were the principal areas of concern. Such standardization smoothed intra-divisional relief, and helped ensure the uninterrupted observation of the enemy line. Furthermore, as subordinate commands shared the same practices and procedures, planning became all the easier.⁶ Other divisions within the corps probably made similar efforts to standardize their intelligence procedures, although any instructions they may have produced went undiscovered in the records reviewed. It seems likely, though, that they would do so given the corps' and, indeed, the British Army's penchant for such standardization.⁷

The Canadian Corps School that opened in September 1916 added further credence to the efficacy of intelligence, as intelligence work formed part of the curriculum. The school had a Sniping Wing whose goal was to enhance the sniping, scouting, observation, and front line intelligence gathering skills of selected officers, NCOs and men. Most of the officers and NCOs attending were from battalion intelligence sections. After completing their courses they returned to their units to teach the others. The ideal candidates were educated and able to read and write (exceptions were made for snipers), although battalions frequently sent uneducated men, much to the chagrin of the instructors. The course lasted a month, and covered all necessary skills for gathering and recording front line intelligence.⁸

⁶ NAC, M.G. 30 E61 (Mitchell Papers) Vol. 14, Folder: Intelligence Corps Instructions (2). "Instructions regarding Intelligence," 1st Canadian Division, August 5, 1916.

⁷ As we saw in Chapter Five, the 2nd Army, as early as August 1915, began issuing intelligence instructions to formations under its command encouraging standard procedures. Revised copies continued to be produced well into 1917, and probably beyond, as the intelligence environment changed. See M.G. 30 E61 (Mitchell Papers) Vol. 14, File 93, for a May 1917 edition of these instructions.

⁸ NAC, R.G. 24, Vol. 1840, Folder: G-A-Q 10-37. "Canadian Corps Scouting[,] Sniping and Observation School," no date. The first class assembled in November, with four officers and thirty-four other ranks in attendance. A similar sized group joined the second class in January 1917. Class three and beyond trained eight to twelve officers and sixty other ranks per class. Two special classes were organized by the Sniping Wing for divisions wanting special, or extra training for their scouts and observers. These lasted sixteen days. In February 1917, the Canadian Corps commented on the poor material sent to the school. Men "who have no wish or aptitude to become Snipers" were being sent by battalions, while "good Snipers

Since intelligence work was such a key element in successful operations, it should come as no surprise that the Canadians made a thorough study of intelligence at the Somme after learning GHQ was about to feed them into that meat-grinder. Fortunately, they had about a month to prepare themselves, and from mid August, officers from the Canadian Corps and its divisions visited other imperial commands at, or just returning from, the Somme to learn the latest tactics and conditions.⁹ Mitchell was one of those officers, and he undertook a comprehensive investigation of imperial intelligence procedures in order “to ascertain how the Intelligence Service which has been in operation in the Canadian Corps during the present trench warfare may be modified and adapted for more open operations similar in character to those carried out at the SOMME.”¹⁰ His report added to the Canadians’ overall understanding of the fighting at the Somme, and the role of intelligence in winning trench warfare.

From his study, Mitchell learned that the Somme offered special intelligence challenges. Conditions were horrendous, and the fighting intense. The landscape

have been given no opportunity of profiting by the instruction. This lack of care in selection produces a mere waste of time at the School and a bad impression of the Battalion’s zeal to inflict loss to the enemy is generated throughout the Corps.” See R.G. 9 III C1, Vol. 3864, Folder 99, File 3. Corps to divisions, February 19, 1917; and R.G. 9 III C3, Vol. 4041, Folder 17, File 8. A report on the sniping course, December 24, 1916. The corps and its divisions also created numerous others schools besides the scouting school for developing the various tactical skills necessary for winning trench warfare. Other British formations did likewise. Some of these schools included mortar schools, gas schools, infantry schools, and machine gun schools.

⁹ Notes prepared from their visits can be found in: NAC, R.G. 9 III C3, Vol. 4043, Folder 2, File 6. “Notes on Intelligence in the Somme Operations,” by Lieutenant Colonel Mitchell, August 16, 1916; Vol. 4146, Folder 8, File 9. 3rd Division to subordinate commands, August 26, 1916; Vol. 4011, Folder 17, File 1. 1st Canadian Division report, August 15, 1916; Vol. 4116, Folder 4, File 3. “Short Notes on Information Obtained From Units In The Somme Area,” 2nd Division, August 29, 1916; M.G. 30 E61 (Mitchell Papers) Vol. 16, Folder Western Front: Orders and Instructions, 1916 - 1918. “Questions and Answers on the Fighting on the Somme Compiled From Notes Made By Brigadier General A.C. Macdonell and Brigadier General A.H. Macdonell.”

¹⁰ NAC, R.G. 9 III C3, Vol. 4043, Folder 2, File 6. “Notes on Intelligence in the Somme Operations,” by Lieutenant Colonel Mitchell, August 16, 1916.

was almost totally bereft of landmarks. There were few fences and hedges left standing from which to orient oneself. What ditches remained were few and far between. There were few farmsteads, and one crop-covered hillock looked much like another. Villages, when left standing, were almost indistinguishable from one another -- they were frequent, small, and all had a cluster of trees. When reduced to rubble they could only be identified with difficulty from photographs. Tracks and routes, difficult to find at the best of times, were removed after even a slight shelling. The terrain changed so quickly that maps were sometimes out of date within days, if not hours, of their production, leaving many commanders confused as to whose army held what portion of ground.¹¹ Add to this the knee-deep mud and the constant German shelling and machine gun fire, and the abject misery of the troops fighting at the Somme becomes more understandable. In such a world, maintaining command and control was exceedingly difficult.

Nevertheless, helping commanders retain some control were the brigade and battalion intelligence sections. Mitchell noted that "All [imperial] Brigades have some kind of organisation of Brigade Observers similar to our own, the number of posts varying with the front and topography." Unfortunately, many of these brigade OPs were inaccessible during the day, while communication to them was "frequently impossible except by nerry runners or visual signalling when weather permits." Mitchell found that due to artillery fire, "Telephones have been out of the question except in a few instances." Despite these problems, Mitchell observed that all the officers he interviewed "are of the opinion that they [brigade observers] are indispensable and are oftentimes of great use in conjunction with Artillery F.O.Os. They are supplied with telescopes, compasses, etc. same as our own at present, and make it a point to make frequent reports when operations are on." In battalions and

¹¹ NAC, R.G. 9 III C3, Vol. 4043, Folder 2, File 6. "Notes on Intelligence in the Somme Operations," by Lieutenant Colonel Mitchell, August 16, 1916.

companies, Mitchell found “considerable diversity in practice and opinion in the employment of patrols and scouts.” Due to the narrow fronts that battalions occupied, some commands did away with company scouts altogether, placing all scouts in the battalion intelligence section; other battalions did the opposite, and disbanded their battalion intelligence sections in favour of a company organization. He also noted that those battalions retaining their intelligence sections tended to employ fewer men than their Canadian equivalents.¹² Regardless of the organization decided upon, however, the scouts kept busy reconnoitring both friendly and enemy lines. Unfortunately for posterity, Mitchell did not comment on the utility of the alternative organizations he described, but as Canadian battalions retained their scout sections during the Somme it is not difficult to see where his sympathies probably resided. The British units Mitchell reviewed also separated their snipers from their scout sections, unlike Canadian practice, and made little use of them (he blamed this on their inexperience and the nature of the fighting, not the organization).¹³

Other Canadians visiting the British lines noted that British commanders made good use of forward observation officers and liaison officers. These officers helped clarify events and maintain order by reporting news that shed light on situations further up the line. General Currie, when commenting on their value as intelligence gatherers wrote: FOOs “must always be keenly alert to bring all necessary or possible Artillery fire to bear on any target at any time,” and that “Forward Observing Officers can often be useful Intelligence Officers, and should

¹² He noted that British and Australian scout sections employed a scout officer, four to six NCOs and sixteen to twenty-four scouts. A 2nd Division report said that imperial and other dominion intelligence sections had about twelve men working under a scout officer. R.G. 9 III C3, Vol. 4116, Folder 4, File 3. “Short Notes on Information Obtained From Units In The Somme Area,” 2nd Division, August 29, 1916.

¹³ NAC, R.G. 9 III C3, Vol. 4043, Folder 2, File 6. “Notes on Intelligence in the Somme Operations,” by Lieutenant Colonel Mitchell, August 16, 1916.

take every opportunity of communicating or sending to Infantry Commanders every possible bit of information that may be of value.” On a related topic, he also wanted battery commanders to direct the fire of their guns more while viewing the front from artillery OPs, a practice he considered important when fighting in the desolate Somme landscape. Liaison work, too, took on special importance at the Somme, with artillery LOs helping commanders come to grips with the infantry action at the front. General Currie noted how in other imperial commands “The Artillery Brigade Commander is always in the closest possible touch with the Infantry Brigadier,” and that artillery officers were also attached to battalions for liaison purposes.¹⁴ The 2nd Canadian Division, as well, was struck by the liaison procedures practiced in other British divisions. All units kept “in very close touch with their subordinate and flanking units” and with the artillery. “The majority of units [the division observed] have a very definite Liaison scheme,” which included officers and men employed on liaison duty staying “with the unit to which they belong during the day and [reporting] to the unit to which they are attached each evening with a full summary of any operations which have taken place, a report on the disposition and situation of their unit, and a statement of any special requirements.”¹⁵

Good maps, of course, were indispensable for command and control. In his investigations before the Somme, Mitchell was impressed by the scale of the British map issue. Companies, and sometimes platoons, had their own maps, and

¹⁴ NAC, R.G. 9 III C3, Vol. 4011, Folder 17, File 1. Currie’s notes on experiences gained by imperial commands at the Somme, August 15, 1916.

¹⁵ NAC, R.G. 9 III C3, Vol. 4116, Folder 4, File 3. “Short Notes on Information Obtained From Units In The Somme Area,” 2nd Division, August 29, 1916. Brigadier Generals A.C. Macdonell and A.H. Macdonell (commanders of 7th and 5th Brigades respectively), in their notes on the Somme, observed that a senior artillery officer was stationed with infantry brigades, while FOOs were with battalions. See NAC, M.G. 30 E61 (Mitchell Papers) Vol. 16, Folder Western Front: Orders and Instructions. “Questions and Answers on the Fighting on the Somme Compiled From Notes Made By Brigadier General A.C. Macdonell and Brigadier General A.H. Macdonell.”

these were of sufficiently large scale to enable units to plan assaults on ground with few landmarks. He liked the fact that many corps produced maps and sketches every night that incorporated the latest intelligence, which they then distributed the next day to lower level commands – an impressive and rapid turn-around of information. The system was, Mitchell observed, reminiscent of Canadian methods employed at Observatory Ridge in June, and he thought it worth expanding. Likewise, the 2nd Division thought the sketches and maps worthy of imitation. However, it recommended that short summaries be attached to them to help clarify various points shown on the maps.¹⁶ As good as the map distribution was, though, Currie noted the poor map reading skills of some officers, and wanted “a great deal of attention paid to Map-Reading” in his division. Too often, he found, officers gave incorrect map references for their locations. “You can see what would happen [he wrote] if you called for Artillery on a certain position on the map thinking that your trenches were in a certain definite place if they were not there at all.”¹⁷ In the ruined landscape of the Somme, accuracy was especially crucial, even if harder to attain.

Mitchell was equally excited with the British practice of widely distributing aerial photographs (issued down to brigades), and saw them as an indispensable tool for mapping the ravaged terrain. But even with the great strides in aerial photography over the years, “in many cases these have been quite insufficient to enable our trenches to be plotted.” Photographs showing mangled woods and tangled trees, for example, obscured the smaller tactical features. Meanwhile, the similarity of fields necessitated extra vigilance when reading photographs in order to distinguish one field from another. It was due to the difficulty of the terrain that Mitchell believed that both corps and division commands had to “pay much more

¹⁶ Ibid.

¹⁷ NAC, R.G. 9 III C3, Vol. 4011, Folder 17, File 1. Currie’s notes on experiences gained by imperial commands at the Somme, August 15, 1916.

attention to the study of photographs.” He further felt that shell holes showing up on photographs required greater scrutiny by photographic clerks and others since the Germans were more and more using craters as machine gun posts and strong points. Interestingly, he found that battalions, except when planning assaults, did not require new photographs to the degree that brigades did; indeed, the turn-around time to produce a regular issue of battalion level photographs would have been prohibitive, slowing down production to unacceptable levels.¹⁸ It was clear from Mitchell’s and the others’ investigations that the wise use of photographs (and all intelligence) gave commanders a greater sense of their environment, and thus greater control over their surroundings.

Canadian officers also studied British efforts to overcome weaknesses inherent in the communication systems then available. Even after two years of war, the collection and transmission of intelligence from the sharp edge slowed down, or collapsed entirely, just at the time when it was needed most. FOOs, intelligence sections, front line officers, and others all tried to send back information, but were often hampered by enemy action. Signals personnel, working in teams and following the assaulting troops, attempted to establish signal stations at pre-selected points in captured enemy terrain to which runners and others could deliver messages for transmission. Unfortunately, signallers regularly suffered heavy casualties or found their signals obscured by the dust and smoke of battle, rendering their efforts in vain.¹⁹ Mitchell saw that the Australians used runners to carry messages from the front almost exclusively, noting that “they have had many casualties among them but say that they have had great success and consider them

¹⁸ NAC, R.G. 9 III C3, Vol. 4043, Folder 2, File 6. “Notes on Intelligence in the Somme Operations,” by Lieutenant Colonel Mitchell, August 16, 1916.

¹⁹ NAC, R.G. 9 III C3, Vol. 4098, Folder 43, File 1. “Preparatory Measures to be Taken by Armies and Corps, Before Undertaking Offensive Operations on a Large Scale,” by 2nd Army. Distributed to Canadian Divisions June 5, 1916.

by far the best means under [battlefield] conditions” for relaying news.²⁰ Despite the signallers and others’ best efforts, it sometimes took hours for messages from the front to percolate back to battalion commanders waiting anxiously in the rear, meaning they were unable to effectively direct the course of battle in an immediate way.

On the other hand, British corps and divisional headquarters were often better informed about events at the front than their more forward headquarters units. This was thanks in large part to the use of airplane contact patrols then being developed and improved. Contact air patrols saw ground troops signal their location to aircraft by flashing shiny objects or by lighting flares, while the pilots, in turn, informed headquarters further to the rear via wireless transmission or message bags dropped at designated drop zones of the latest dispositions and predicaments faced by the infantry. Mitchell observed that contact patrols have “been particularly successful, and [are] now being practiced in various forms to obtain improvement in details.”²¹ Currie also witnessed airplane contact patrols in operation, stating that the British had been using the system “very successfully...to locate the position of our Infantry.”²² Contact air patrols ‘telescoped’ corps and divisional commanders directly into the action since aerial observers could report their observations within minutes of making them. As such, the Canadians

²⁰ NAC, R.G. 9 III C3, Vol. 4043, Folder 2, File 6. “Notes on Intelligence in the Somme Operations,” by Lieutenant Colonel Mitchell, August 16, 1916. The Brigadiers visiting the 17th British Division noted that pigeons were sometimes put to good use and could, under the right conditions, secure for the infantry an artillery response in eight and a half minutes. They agreed with Mitchell, though, that runners did “splendid work” and ran “right through the barrages from shell hole to shell hole” to deliver messages. See NAC, M.G. 30 E6 I (Mitchell Papers) Vol. 16, Folder Western Front: Orders and Instructions. “Questions and Answers on the Fighting on the Somme Compiled From Notes Made By Brigadier General A.C. Macdonell and Brigadier General A.H. Macdonell.”

²¹ NAC, R.G. 9 III C3, Vol. 4043, Folder 2, File 6. “Notes on Intelligence in the Somme Operations,” by Lieutenant Colonel Mitchell, August 16, 1916.

²² NAC, R.G. 9 III C3, Vol. 4011, Folder 17, File 1. Currie’s notes on experiences gained by imperial commands at the Somme, August 15, 1916.

practiced contact patrolling with their affiliated squadron in the weeks prior to entering the Somme. Too much cannot be said on the importance of the development of the contact air patrol.

Equally important were the air observers spotting for the gunners, as the information they supplied increased the alacrity of artillery action. Since the artillery was more and more deciding the outcomes of battles, the ability of artillery spotters to keep the gunners informed of events at the front was a major breakthrough.²³ By quickly learning of developments facing the infantry, and the location of other suitable targets, the artillery could take better advantage of fleeting opportunities such as massing enemy infantry, and come to the assistance of friendly troops held up by German strong points. Meanwhile, reports trickling in from the signallers, or through SOS calls, or sent in by FOOs and LOs through the various brigade headquarters, added further flexibility to the command structure. This more dexterous arrangement came at a propitious moment for gunners who increasingly found their contribution to battle tied more and more closely to the fixed time-tables of the creeping barrage.²⁴ The improved information flow meant that the artillery retained some ability to respond to changing circumstances. This

²³ Spotting on behalf of gunners was not a simple matter of flying over enemy lines and reporting all that was seen. Aerial observers entered into a kind-of symbiotic relationship with the artillery, working for hours on end, over extended periods of time to develop a close working relationship that saw each service learn the idiosyncrasies of the other.

²⁴ The creeping barrage -- an artillery tactic introduced early in the Somme fighting in response to the difficulty of locating and destroying enemy positions -- saw friendly gunners lay down a curtain of fire that they slowly, and with a uniform and predetermined speed, advanced across no man's land and over the enemy's position. The advancement of the barrage was synchronized to the estimated walking speed of the infantry following closely behind (or leaning into the barrage). The idea was that the artillery would walk the infantry over and on to the German lines before the Germans had time to recover from the artillery pounding. It was a tactic that required a great deal of ammunition and precision timing, and was designed to smash everything, and cow everyone, in its path. The side effect of this tactic was that it cratered the ground so extensively that it added to the burden of the troops crossing the field, while providing new shell hole cover for the defending Germans. This last point sparked Mitchell's call for greater scrutiny of shell holes by photographic clerks.

same flexibility helped commanders decide when and where to commit reserves, for they now had a better idea of the needs of the men at the front.

Yet even with all their study and practice the Canadians found the fighting at the Somme tough going. They achieved their share of success, of course, but also their share of disappointments. While the Canadians were tenacious at Courcellette and Thiepval Ridge in September, advancing the line considerably, their assaults on Regina Trench that same month and in early October were failures. The Canadian Corps -- less the 4th Canadian Division newly arrived at the front -- left the Somme in mid October without securing Regina Trench, which remained firmly ensconced in German hands. Another month passed before the 4th Canadian Division managed to wrest the trench from the Germans. The Canadians, in their efforts to move the line several thousand yards, suffered 24,029 casualties in three months. The difficulty of the fighting was partly due to revised German defensive tactics that placed fewer men but more machine guns in forward defensive outposts and shell holes, and to the Canadians' less than satisfying counter battery work. Too many hostile batteries survived to inflict damage on the assaulting troops. Furthermore, the linear assault tactics practiced by the Canadians were out of date for the type of defence the Germans put up. On top of these problems lay the mixed performance put in by the intelligence gatherers. Add to these difficulties the deep mud and the constant shelling, and it is easy to appreciate why progress was slow.

Intelligence work had a bearing on the outcome of each of the Canadian actions fought at the Somme. At Flers-Courcellette in mid September, the 2nd Division, supported by the 3rd Division, launched an assault "to secure points of observation near Courcellette" about 1,000 yards distant. This assault was part of a larger attack carried out by the British Fourth Army, and is perhaps best known for

the first use of tanks in warfare.²⁵ Much has been written about the tanks, and how they were a portent for the future. But the Canadian success at Courcellette was more the result of artillery action than of the seven tanks allotted to the Canadians for their part in the advance. In the days leading up to the assault the Canadians amassed a great deal of intelligence on their objectives, the German defences, and the intervening terrain. From this information the artillery developed a shelling program that saw the German positions plastered with increasing intensity in the days before the infantry assaulted. The systematic destruction of specific tactical features was the goal of this bombardment, and the results were checked by clerks and others against aerial photographs of the ground bombarded.²⁶ Ground observers, too, monitored the destruction to confirm that all was going as planned. During the actual assault the creeping barrage smothered the German positions with shells, forcing the defenders to keep low, thus preventing them from manning any machine guns and defensive works that survived the preliminary bombardment. At the same time, a standing barrage rested on specific targets.²⁷ The artillery pounding was so severe that, as at Mount Sorrel, the infantry gained their objectives in little more than an hour. The German defenders were so disrupted by the assault that impromptu attacks launched by the Canadians later that day pushed on to capture the town of Courcellette and its environs.

In addition to helping shape the artillery plan, intelligence on the German positions let commanders retain some control over the fighting. The commander of the 6th Brigade, prior to the assault, wanted “once again to most strongly impress on all C.Os., Company Commanders, and Platoon leaders, throughout the Brigade,

²⁵ John Swettenham, *To Seize the Victory. The Canadian Corps In World War I* (Toronto: The Ryerson Press, 1965), 117 - 118.

²⁶ Wilfrid Miles, *Military Operations France and Belgium, 1916, Vol. II* (London: Macmillan and Co., Limited, 1938), 297.

²⁷ Swettenham, *To Seize the Victory*, 118.

the absolute necessity of not only Officers but every N.C.O. and man who is taking part in this operation knowing his place, work and exactly what is expected of him.”²⁸ Rehearsals, and the study of intelligence, let them do this. Mock battles and tactical exercises, for example, taught machine gunners and trench mortarmen how to cooperate with the infantry.²⁹ Meanwhile, helping to maintain control once the action started were the various intelligence sections. Men from these units manned OPs, and reconnoitred the lines. In the 21st Battalion, “Soon after the attack had taken place two parties [of scouts from the scout section] were sent out...to report on the situation. Both parties returned with the information that all our objectives had been gained, and we had connected up with the 20th Canadian Battn. on our right, and 27th Battn. on our left.” Later, the intelligence section maintained touch with the men holding out around the Sugar Factory, guiding up reinforcements and bringing back wounded. The commander felt that “The work of the Section throughout was carried on with thoroughness and precision, every man being employed and showing devotion to duty.”³⁰ The reports these and other men sent back helped commanders maintain some sense of order. In the 27th Battalion, for example, each company commander recorded their locations on blank situation maps provided for that purpose as soon as they reached their objectives. They also detailed “one NCO and one man to report nightly to [Battalion Headquarters] with all information obtained during the day.” In the meantime, observers from the battalion scout section kept the commander informed of the progress of the attack, for prior to the advance observers had been posted on both flanks of the battalion to watch and report on the fighting. “Everything should be reported to Bn. H.Q. as it

²⁸ NAC, M.G. 30 E5 (Bovey Papers) Vol. 4, Folder 21. 6th Brigade to subordinate commands, September 12, 1916.

²⁹ Bill Rawling, *Surviving Trench Warfare: Technology and the Canadian Corps, 1914 - 1918* (Toronto: University of Toronto Press, 1992), 74-75.

³⁰ NAC, M.G. 30 E50 (Jones Papers) Folder 2. 21st Battalion report on the work of the scout section, September 23, 1916.

occurs," declared the battalion's instructions. At the same time, the battalion scout officer, with a party of scouts, followed the advance "checking up the position of the enemy and our own positions." They also patrolled the area in front of the newly won line, thereby maintaining contact with the enemy. The scout officer gathered additional information from the walking wounded "from whom much information can be obtained."³¹

Staff captains(I) and brigade intelligence sections had their roles to play as well. In the 7th Brigade, for example, "after rendering almost invaluable services, in first reconnoitring positions, and placing O.Ps. etc.," the staff captain(I) "was constantly on the move during the heaviest barrages visiting O.Ps. and Battalion Headquarters, and keeping me [the brigade commander] in touch with everything." He was, to the brigade commander's "deep regret," seriously wounded. Brigadier-General A.C. Macdonell, the brigade commander, added: "The Brigade can ill afford to lose his efficient services, a shrewd, clear-headed, gallant Intelligence Officer, much liked and in close touch with all Units of the Brigade."³²

Liaison work was also effectively arranged at Flers-Courcelette. Not only did assaulting brigades exchange liaison officers, but battalions adjoining neighbouring brigades exchanged them as well. Battalions within brigades also swapped liaison officers and each sent one to brigade headquarters. Runners accompanied these officers to ensure touch was maintained with their home commands. Meanwhile, officers from brigade machine companies and trench mortar batteries kept in touch with the infantry by establishing report centres at the headquarters of one of the attacking battalions, where they received reports and

³¹ NAC, M.G. 30 E5 (Bovey Papers) Vol. 4, Folder 21. 27th Battalion "Advanced instructions with regard to Operation Orders No. [80?] Appendix 'A'".

³² NAC, R.G. 9 III C1, Vol. 3842, Folder 43, File 13 - 14. "7th Canadian Infantry Brigade. Narrative of Events," September 22, 1916.

coordinated their efforts.³³ A number of battalions also combined their headquarters at one location, easing liaison considerably. On at least one occasion, though, the Canadians were overly exuberant when it came to liaison. In late September, during a separate attack near Courcelette, the 1st Brigade complained that four artillery LOs showed up at the 2nd Battalion's headquarters, each representing a different artillery brigade. The result was an overcrowded headquarters, and a frustrated battalion commander who found their presence a hindrance rather than an aid to operations. When artillery support was needed, the commander did not know which LO to turn to for the best response.³⁴

Communications, of course, remained vital for the speedy transmission of intelligence during the action. Telephones, pigeons, runners, and visual signals connected battalion headquarters to their parent brigades. Where possible, signallers buried telephone cables six feet deep. The 27th Battalion reminded its company and section commanders that "communication is half the battle and unless the O. C. knows exactly what is going on he cannot assist in any shape or form."³⁵ It was imperative, then, that the assaulting units continually send back reports. To help deliver word from the front to commanders in the rear, signallers established signal stations in the captured enemy lines at points selected prior to the advance. In the case of the 27th Battalion, company signallers followed behind the fourth wave and laid four separate telephone lines, one to each company. Once in place these stations were connected laterally to each other as soon as possible. Despite the enormous effort this entailed, the battalion stated that communications from the

³³ NAC, M.G. 30 E5 (Bovey Papers) Vol. 4, Folder 21. 6th Brigade to subordinate commands, September 12, 1916.

³⁴ NAC, R.G. 9 III C3, Vol. 4026, Folder 11, File 3. 1st Brigade to 1st Division, November 21, 1916; M.G. 30 E5 (Bovey Papers) Vol. 4, Folder 21. 27th Battalion "Advanced instructions with regard to Operation Orders No. [80?] Appendix 'A'".

³⁵ NAC, M.G. 30 E5 (Bovey Papers) Vol. 4, Folder 21. 27th Battalion "Advanced instructions with regard to Operation Orders No. [80?] to be issued later," September 13, 1916.

forward-most positions “may eventually come down to runners.” Pigeons, too, were employed, as were visual signals, and through one means or another, word eventually percolated back.

The Canadian assault at Flers-Courcelette also benefited from the first use of tanks in warfare. While the Canadians were not overly enthusiastic about the tanks' performance -- only one managed to reach its assigned objectives -- their presence did shake the morale of the German defenders, and no doubt contributed to the Canadian success.³⁶ But as the Canadians only received their complement of seven tanks in the days just prior to the attack, there was little time for the tanks and infantry to train together. Indeed, the infantry's plans were made “irrespective of them,” as the Canadians were uncertain if they would even receive the tanks offered.³⁷ Communications were maintained between the tanks and the infantry and between the tanks and aircraft by means of “Simple flag and lamp codes...in order to signal ‘out of action’ and ‘am on objective.’” A number of tanks also carried pigeons for relaying information. As with the infantry and the artillery, the tanks followed a pre-set plan, and so did not just aimlessly wander no man's land in search of targets or something to crush. Tank commanders learned of their attack routes from divisional staff officers. These later officers also reviewed aerial and panoramic photographs with the tank commanders. The course of each tank across no man's land was marked on maps showing the bearings each would follow. From this information, and from the specifics of the corps time-table, each tank commander then prepared his own map “showing the distinctive features of his

³⁶ Fraser, Donald, *The Journal of Private Fraser, Canadian Expeditionary Force 1914-1918*, ed. Reginald Roy (Sono Nis Press, 1985; reprint, Nepean, Ontario: CEF Books, 1998), 208. Rawling, *Surviving Trench Warfare*, 83; G.W.L. Nicholson, *Official History of the Canadian Army in the First World War, Canadian Expeditionary Force 1914-1919* (Ottawa: Queen's Printer and Controller of Stationary, 1962), 169-170.

³⁷ NAC, M.G. 30 E5 (Bovey Papers) Vol. 4, Folder 21. 27th Battalion “Advanced instructions with regard to Operation Orders No. [80?] Appendix ‘A’”.

route, his compass bearing from point to point, and the time at which he must arrive at each.” As the British official history relates, many of these “young and inexperienced tank commanders found themselves overburdened with directions and instructions, which, in many cases, had to be memorized, as there were not enough copies [of the instructions] to go around.”³⁸ Under such circumstances it is a wonder that the tanks did as well as they did.

In October, Canadian assaults against Regina Trench ended with a far less happy outcome than the Battle of Flers-Courcelette. Once again intelligence, or the lack of it, played a role in the Canadian failure to capture and hold newly won positions. This is not to argue that intelligence is the sole ingredient for success in battle, but it is to suggest that good or adequate intelligence helps win battles, while poor intelligence helps lose them. It is significant that General Currie, when explaining his division’s reverse at Regina Trench on October eighth, points to poor intelligence work as a contributing factor in his command’s defeat. Patrol reports, for example, suggested that the artillery had effectively removed the German protective wire. From these reports Currie “came to the conclusion that while a certain amount of wire was to be expected, it would offer no serious obstacle. The attacking troops were warned of this and additional wire cutters served out as an extra precaution.” Events proved the reports wrong. Currie wrote:

Reports on the condition of the wire were unsatisfactory. Observation on the wire was poor from the position occupied by our Infantry Observers and the limited time at the disposal of the Division did not permit of a protracted search for suitable O.P.s. Patrols were sent out, but owing to [the rapidity of] reliefs these men never became thoroughly acquainted with the ground and their reports have since been proved to be very inaccurate. Owing to weather conditions Aeroplane reconnaissance photos were not available.

³⁸ Miles, *Military Operations, 1916*, 297 (and footnote 2).

In addition, Currie noted that patrolmen were inexperienced due to the large influx of green troops necessary after the heavy casualties suffered in previous engagements. The result was that attacking troops in some units got caught on the wire, and were mowed down by enemy machine guns. In other units the wire drove the men into the trenches where they tried to make their way to their objectives by bombing their way forward from trench to trench. They were unprepared for this type of close fighting, however, and soon ran out of grenades. German counter attacks forced them back to their start lines.³⁹

Poor patrol reports were not just a 1st Division complaint. The 3rd Division, likewise, found the wire along its front uncut. For some days prior to the attack the artillery had been carrying out “a systematic bombardment of the enemy’s rear lines and of the REGINA TRENCH and the wire in front of it.” Accurate shooting was difficult, however, due to high winds and poor weather. To ensure the wire was cut, reconnaissance patrols and observers checked on its condition daily. These reported that “the wire in front of REGINA TRENCH had for the most part been well cut.” Later, of course, “it was found...that considerable wire remained and this fact...materially affected the success of our operations.” Companies from the 49th Battalion, 7th Brigade, for example, after advancing through a row of well cut wire ran into a second belt that was “entirely undamaged.” “Seeking to find gaps which might afford an entrance to the trench our men worked their way along the front of the wire but failed to find any openings and losing heavily eventually got into KENORA TRENCH.” Three times these survivors tried to bomb their way forward, but were eventually “wiped out as the Germans had concentrated in considerable force...and were supported at this point with at least two machine guns.” The 9th Brigade fared no better. “Nowhere

³⁹ NAC, M.G. 30 E100 (Currie Papers) Vol. 35, File 159. 1st Canadian Division to Canadian Corps in reference to reasons for the failed assault against Regina Trench on October 8, 1916.

had the wire been damaged by our artillery to any appreciable extent,” said the 3rd Division’s after action report. German machine guns reaped their harvest as the infantry tried to cut their way through. That any of the men managed to force their way through seems miraculous, yet some did, and they held out for thirty minutes before finally being driven out.⁴⁰

Besides patrol work, other attack preparations, too, were sometimes poorly carried out. Despite Currie’s order to rehearse the assault, for example, one battalion did not bother to, and Currie blamed this for its failure to gain its objectives on the eighth.⁴¹ Other officers, much to Currie’s annoyance, simply pointed out their commands’ objectives to their subordinates by referring to maps rather than showing them the actual position on the ground. Currie, likely remembering his days at Festubert in 1915, said: “To tell a Machine Gunner to take up his position at M.14.b.2.6. or a Bomber to establish a block at M.8.d.3.0. is an absurd order unless some other means of fixing this position has been explained.”⁴² Other officers and NCOs, Currie discovered, could not read a map in the first place. It was hard to win a war when objectives were shrouded in such mystery.

It was more than just the lack of accurate pre-battle intelligence that contributed to the defeat at Regina Trench on October eighth. The collection and sharing of information during the battle was also weak. The work of artillery liaison officers, despite some admirable success, was disappointing. Currie, no doubt, cursed a blue streak when he learned that no artillery liaison officer showed up at the 13th Battalion’s headquarters. The liaison officer scheduled for that command made his way to the 16th Battalion’s headquarters instead. “He remained

⁴⁰ NAC, R.G. 9 III C1, Vol. 3843, Folder 45, File 4-5. “3rd Canadian Division War Diary Narrative of Operations From 3rd October to 11th October, 1916.”

⁴¹ Rawling, *Surviving Trench Warfare*, 74.

⁴² Currie as quoted in Daniel Dancocks, *Sir Arthur Currie: A Biography* (Toronto: Methuen, 1985), 79.

with the 16th all day, brought with him no telephone and was of no use whatever.” Although Currie did not believe that his presence with the 13th Battalion would have reversed that battalion’s set-back on the wire, that LO’s poor performance was a microcosm of liaison difficulties that day. Currie concluded that “the manner in which the Artillery Liaison Officers carried out their orders, shows a lack of discipline which is unpardonable.” Poor liaison work, however, was not entirely the artillery’s fault. Battalion commanders, Currie observed, should have reported the absence of liaison officers immediately; indeed, “Brigades reported all arrangements complete.”⁴³ Finally, Currie found that some LOs were misused, and ended up being “nothing more than a runner,” or were “very often very inexperienced and consequently they were of very little value to the Units to which they were attached.”⁴⁴

Communications from the infantry at the front were also slow. In the 7th Brigade, although the attack went in at 4:50 a.m., “no definite news had been received of the three attacking companies of the 58th [Battalion] nor of the left Company of the 43rd Battalion,” until 11:40 a.m. -- almost seven hours later. At that time Brigade headquarters ordered the two battalions to send out patrols to learn the situation along their front, and “to find out if REGINA TRENCH was held by any of our troops, and if so to reinforce them.” Brigade headquarters also sent forward a staff officer -- perhaps the staff captain(I) -- to learn the state of affairs on behalf of the brigade commander. By then, of course, it was too late to help the advancing troops, for as we have seen, most were “wiped out.” The lack of information had cost the assaulting troops dearly.⁴⁵

⁴³ NAC, M.G. 30 E100 (Currie Papers) Vol. 35, File 159. 1st Canadian Division to Canadian Corps in reference to reasons for the failed assault against Regina Trench on October 8, 1916.

⁴⁴ NAC, R.G. 9 III C3, Vol. 4011, Folder 17, File 1. Currie’s lessons on the Somme, November 25, 1916.

⁴⁵ NAC, R.G. 9 III C1, Vol. 3843, Folder 45, File 4-5. “3rd Canadian Division War Diary Narrative of Operations From 3rd October to 11th October, 1916.”

The work of FOOs also came under review. While Currie was pleased that during his division's attack on October eighth the heavy artillery was able to beat-off a German counter attack thanks to the observations of one of that formation's FOOs, he was, on the whole, of the opinion that FOO work required improvement. He thought that the heavy artillery's forward observers should have been closer to the front. It should have been easy, he mused, for FOOs to have had telephonic communication to infantry battalions, yet this did not regularly occur. Currie also discerned a lack of proficiency amongst officers of the divisional artillery in observation work; too many were, in Currie's judgment, inexperienced.⁴⁶ Units from the 3rd Division, also having attacked on October eighth, agreed. The 2nd and 4th Canadian Mounted Rifles (CMR) felt that artillery observers were too far back to keep in touch with the actual situation, and believed that even those stationed at battalion headquarters were not close enough. The 4th CMR went so far as to say that wire remained uncut because FOOs were not close enough to see that this was the case.⁴⁷

Currie's command was also unlucky that day. Most of the SOS rockets carried forward by the assaulting battalions, and used for calling for artillery support against German counter attacks, had been lost to enemy shell fire. Of those that survived, several did not light properly. Artillery support came only after the gunners were reached by telephone. Luckily, telephone connections between brigades and battalions were, for the most part, good on the eighth.⁴⁸

The Canadian Corps, less the 4th Division, withdrew from the Somme

⁴⁶ NAC, M.G. 30 E100 (Currie Papers) Vol. 35, File 159. General Currie's report on the October 8, 1916 assault by the 1st Division.

⁴⁷ NAC, R.G. 9 III C3, Vol. 4162, Folder 9, File 6. 2nd and 4th CMR "Lessons Learnt From Operations on the Somme," November 14th, 1916 and no date, respectively.

⁴⁸ NAC, M.G. 30 E100 (Currie Papers) Vol. 35, File 159. 1st Canadian Division to Canadian Corps in reference to reasons for the failed assault against Regina Trench on October 8, 1916.

before Regina Trench was won. In October and November it was the 4th Division's turn to try and wrest it and Desire Trench from the Germans. Although the division found the fighting hard-going, and suffered some set-backs on the way, in the end it succeeded in capturing both Regina and Desire Trenches. Fortunately, it had the experiences of the other three Canadian divisions to draw on.⁴⁹ Good intelligence, along with hard pounding by the artillery, coupled to the stubborn tenaciousness now common in Canadian units, helped this command win its objectives.

Units from the 4th Division did not neglect to rehearse their assaults. The 54th Battalion noted how all ranks, instructed in their roles for the assault on Desire Trench, carried them out as planned. So well practiced were the men that the battalion commander "was therefore not called upon to do anything." The 87th Battalion had a similar experience.

In the attack of October 21st we had great success...partly due to the fact that everybody was well acquainted with the landmarks. A week before going up we made a model on a piece of ground in our camp of the area which we should have to go over. This showed all contours, villages, trenches, C.T's [communication trenches] and other landmarks and as every man in the Battalion had been instructed in it and studied it the consequence was that once in the area they felt that they knew where they were.⁵⁰

As at Mount Sorrel, thorough preparations compensated for command inability to direct the action while it raged.⁵¹ Detailed planning let commanders work out decisions in advance, when the stresses and strains of battle were at their minimum.

⁴⁹ For example, the 4th Division prepared a study in September titled "Nature of Fighting on the Somme" from lessons learned by the other divisions. No doubt they continued to follow the action closely until it was their turn in the lines. M.G. 30 E5 (Bovey Papers) Vol. 4, Folder 26.

⁵⁰ NAC, M.G. 30 E300 (Odlum Papers) Vol. 19, Folder: Reports, Brigade Orders (11th C.I.B.) December 1916. 87th Battalion report on the Somme, December 18, 1916.

⁵¹ NAC, R.G. 9 III C1, Vol. 3843, Folder 44, File 1. 54th Battalion report on the Somme.

Such complex, minute by minute instruction reached perfection at Vimy Ridge in 1917, but even at the Somme, as the 4th Division's experiences showed, detailed planning decreased the confusion, friction, luck, and uncertainty of battle.

If communications during battle had been more reliable, such extensive planning might not have been so necessary; the timely flow of news would have restored immediacy to the battlefield for commanders in the rear, thus allowing them to better intervene in the action as it swirled about them. Brigadier-General Victor Odium, commander of the 11th Brigade, made this very point when he wrote that "A Battalion commander can only influence an attack once launched by having a reserve at his disposal and under his hand, and only then if his system of communication has stood the test and his observers and company commanders are able to send him prompt and accurate information."⁵² As it was, however, battalion and brigade commanders could do little once a battle began. The 8th Brigade reported that commanders could only intervene in a fight when deciding whether or not to commit reserves. At other times "The noise, smoke, dust and enemy barrages, during an attack makes observation and personal control impossible." The 5th CMR echoed this opinion: "When the attack is launched the [battalion] Commander has very little influence,[sic] on the situation until some complication arises." For the most part, commanders had to trust to their subordinates to carry plans through to their completion. The 19th Battalion stated that "Once the attack is launched control passes out of the hands of all above the Platoon Commander." The 22nd Battalion reported that "Once the attack is launched the Battalion Commander is practically impotent except in so far as neutralizing the inevitable counter attack. His influence will be governed largely by the rapidity and accuracy

⁵² NAC, M.G. 30 E300 (Odium Papers) Vol. 19, Folder: Reports, Brigade Orders (11th C.I.B.) December 1916. "Lessons from the Somme." The 75th Battalion made the same claim in its report on the Somme in R.G. 9 III C1, Vol. 3843, Folder 44, File 1.

of his information as to the situation.” Currie, in his summary of lessons learned at the Somme, said much the same thing: “Once the attack is launched, the Battalion Commander cannot influence the situation until it has been cleared up sufficiently to enable him to judge where to use his Reserve if required.”⁵³

It was in clearing up situations that the intelligence system was of value during a fight. Unlike the 1st Division’s experiences with ground observers, the 4th Division was almost universal in its praise of their work, stating that brigade OPs repaid the care expended on building them.⁵⁴ Throughout the fighting there were always staff captains(I) or brigade commanders on duty in them keeping in touch with events as they unfolded.⁵⁵ The 11th Brigade, too, was highly laudatory of observation work.

An Observation Post was established in a commanding position behind and connected to the Brigade Commander by telephone. During the first operation [October twenty-first against Regina Trench] the Brigade Intelligence Officer kept the G.O.C. informed minute by minute of the progress of events and as a result, on several occasions artillery action, promptly ordered, nipped off budding counter attacks.

Unfortunately, “In the last operation [November eighteenth against Desire Trench]

⁵³ NAC, R.G. 9 III C3, Vol. 4089, Folder 20, File 4. 4th and 5th Brigade “Lessons Derived from the Operations on the Somme;” Vol. 4153, Folder 4, File 2. 8th Brigade report on the Somme, December 1916; Folder 4, File 3. Royal Canadian Regiment report on the Somme to 7th Brigade, November 19, 1916; Vol. 4162, Folder 9, File 6. 1st and 5th CMR, “Lessons Learnt From Operations on the Somme;” Vol. 4011, Folder 17, File 1. 1st Division to Canadian Corps, 1916.

⁵⁴ The 50th Battalion, though, was one command that thought that observers could have been better used to help control the action and guard against inaccurate situation reports. NAC, R.G. 9 III C1, Vol. 3843, Folder 44, File 1. 50th Battalion report on the Somme, December 16, 1916.

⁵⁵ NAC, R.G. 9 III C1, Vol. 3843, Folder 44, File 1. 4th Division’s “Lessons to be Derived From Operations on the Somme,” December 23, 1916.

observation was impossible owing to weather conditions.”⁵⁶

Similarly, the performance of liaison officers was positive in the 4th Division. Each attacking brigade sent an officer to its neighbouring brigade for liaison purposes, and each battalion flanking a battalion from another brigade did the same, as did companies. The 38th and 85th Battalions thought that liaison with neighbouring battalions worked well, but that channels of communication were sometimes difficult to maintain.⁵⁷ Meanwhile, the artillery sent liaison officers to each attacking brigade and gave each a direct line to the supporting batteries. Artillery LOs were with battalions as well. The 44th Battalion was happy with its LO, noting he was well forward. The 50th Battalion was, likewise, satisfied with its artillery liaison officer, although maintaining touch with neighbouring battalions was more difficult, as there were no lateral telephone connections. There were no hitches with the liaison arrangements in the 54th Battalion either, but the commanding officer noted that the information received was often late in coming or inaccurate. The 75th Battalion found liaison indispensable, and that even closer touch with the gunners was necessary.

There were problems, of course. The gunners and the infantry did not always understand the difficulties and needs of the other. Often there were too few FOOs, and of those available too many made poor observations. Indeed, the commander of the 72nd Battalion felt there was much room for improvement. He noticed that the LO working with him sat in the battalion headquarters and waited to be told to contact his guns, rather than taking the initiative. He also complained that artillery LOs laid their telephone lines so poorly that they readily broke down. They then had to use the infantry's lines “with the result that the sole advantage of having

⁵⁶ NAC, R.G. 9 III C1, Vol. 3843, Folder 44, File 1. 11th Brigade's “Lessons From the Somme,” December 20, 1916.

⁵⁷ NAC, R.G. 9 III C1, Vol. 3843, Folder 44, File 1. 4th Division's “Lessons to be Derived From Operations on the Somme,” December 23, 1916. In the same file are the 38th, 44th, 54th, 72nd, 75th, 87th Battalion reports.

a Liaison Officer, namely, two wires to the Artillery, is lost.” The commander felt that he could do the job just as well as the LO sent to his unit. His frustration was made clear when he reported that he tried many times to arrange artillery fire against German work parties to no avail. He eventually gave up trying “and the Enemy’s work proceeded” unmolested. Overall, while liaison may have been sometimes slow, or poorly carried out, it did provide one more channel for sharing information and of keeping commanders aware of their surroundings.

Notwithstanding the 4th Division’s success at the Somme, there were some problems universal to all the Canadian divisions. Liaison with the heavy artillery, for example, was an area of concern. The infantry found it difficult to obtain heavy artillery support on short notice. Some divisional LOs and FOOs did not know which heavy artillery batteries covered their front, and so did not know what guns to contact in a crisis, or the best means to do so. By year end, though, some improvements had been made, including the posting of instructions in battalion telephone exchanges describing the fastest way to contact the heavy guns, and the further instruction of LOs and FOOs in their duties.⁵⁸

The Somme also pointed out a general deficiency in some basic skills. Apparently, many officers had difficulty preparing situation reports, reading maps, and carrying out reconnaissance missions. The 10th Brigade recorded that the absence of landmarks made it very difficult to locate positions on the ground; a sentiment echoed by the 46th Battalion.⁵⁹ As a consequence, situation reports were not always as accurate as they might have been. The 19th Battalion observed that because the terrain changed so rapidly maps were often inaccurate, which added to

⁵⁸ NAC, R.G. 9 III C3, Vol. 4158, Folder 1, File 7. Canadian Corps to 3rd Division regarding conference notes, December 19, 1916.

⁵⁹ NAC, R.G. 9 III C1, Vol. 3843, Folder 44, File 1. 10th Brigade’s report on the Somme, December 20, 1916; 46th Battalion report on the Somme.

the problems of preparing accurate situation reports.⁶⁰ The 1st CMR agreed, noting that maps were of too small a scale and not up to date.⁶¹ The 75th Battalion resigned itself to the fact that situation reports were going to be wrong, and could offer no solution to fix the problem. "I cannot suggest any further orders, instructions or precautions to ensure accurate reports," wrote the commander. He added:

Intelligent officers, who have personally observed the objective as far as possible, from our front line studied the situation on their maps, and rehearsed the operation time after time, seem to fail to locate themselves on arrival at the objective. This must be due to excitement, the different appearance of everything from the other end, and lack of landmarks, similarity of trenches, difficulty of observation under fire, etc.⁶²

Rather than blaming the devastated terrain for its mapping difficulties, the 50th Battalion put the blame on officers and NCOs with "insufficient knowledge of Map reading." The battalion commander thought that better observation work, along with larger scale maps, would have lessened the problem.⁶³ The 25th Battalion noticed, as well, that officers lacked the ability to describe their positions accurately on paper, rendering their reports meaningless or confusing. The inability of some officers to read a map and use a compass was also a problem in the 18th Battalion.⁶⁴

This is not to suggest that all commands suffered with poor reportage. The 11th Brigade found the situation reports it received very useful. Each battalion

⁶⁰ NAC, R.G. 9 III C3, Vol. 4089, Folder 20, File 4. From the 4th Brigade's "Lessons Derived From the Operation on the Somme."

⁶¹ NAC, R.G. 9 III C3, Vol. 4162, Folder 9, File 6. 1st CMR's "Lessons Learnt From Operations on the Somme," November 20, 1916.

⁶² NAC, R.G. 9 III C1, Vol. 3843, Folder 44, File 1. 75th Battalion report on the Somme.

⁶³ NAC, R.G. 9 III C1, Vol. 3843, Folder 44, File 1. 50th Battalion report on the Somme, December 16, 1916.

⁶⁴ NAC, R.G. 9 III C3, Vol. 4089, Folder 20, File 4. From the 4th Brigade's "Lessons Derived From the Operation on the Somme."

officer had a small map of the area his battalion was attacking, and on it was clearly marked reference points. As objectives were reached, officers filled out their position on the maps in relation to the features delineated and sent them back to rear commanders where “they provided valuable information.”⁶⁵ Practice over the training grounds helped make officers and men familiar with the various features left standing. The 87th Battalion, likewise, saw no difficulties with situation reports. Each officer and NCO was acquainted with the landmarks, and each carried blank maps on which they recorded their locations.⁶⁶

Equipment shortage was another difficulty the Canadians faced at the Somme. Brigadier-General G.B. Hughes, commanding the 1st Brigade, complained that equipment shortages had a detrimental effect on operations. “The lack of telescopes, compasses, protractors, etc.,” he wrote, “was never more keenly felt than in the SOMME area where a great deal of long range observing was done.”⁶⁷ The 21st Battalion, likewise, bemoaned a compass shortage.⁶⁸ Equipment shortage, unfortunately, was a problem that lasted as long as the war.

Reconnaissance work also received mixed reviews. Currie noted that divisional and brigade staff officers made too few tours of the front to learn the true situation. Too often, Currie believed, commanders believed hearsay, and too readily accepted “first statements as proof positive.”⁶⁹ This was echoed in the 25th Battalion, whose commander also found that too many officers were too willing to

⁶⁵ NAC, R.G. 9 III C1, Vol. 3843, Folder 44, File 1. 11th Brigade’s “Lessons From the Somme,” December 20, 1916.

⁶⁶ NAC, R.G. 9 III C1, Vol. 3843, Folder 44, File 1. 87th Battalion report on the Somme.

⁶⁷ NAC, R.G. 9 III C3, Vol. 4026, Folder 11, File 3. Report by the 1st Brigade on intelligence work carried out at the Somme, October 28, 1916.

⁶⁸ NAC, R.G. 9 III C3, Vol. 4089, Folder 20, File 4. From the 4th Brigade’s “Lessons Derived From the Operation on the Somme.”

⁶⁹ NAC, R.G. 9 III C3, Vol. 4011, Folder 7, File 1. Major-General Currie to Canadian Corps on the lessons learned from the Somme battles, November 25, 1916.

assume information was correct.⁷⁰ Again, the 11th Brigade proves that some commands had positive experiences. “Within three hours after [the] attack was launched, Brigade officers made the complete round of the newly captured positions and reported the situation in detail.”⁷¹

Shockingly, some officers, even after all the Canadian Corps had gone through in the past year and more, still took lightly the work of intelligence officers. According to the 2nd Battalion’s historian, an officer working for Sir Max Aitken, the Canadian government’s ‘Canadian Eyewitness,’ arrived at the battalion’s headquarters September 9, 1916. He was there to film a Canadian assault. The Battalion commander, busy with more pressing matters, passed the officer over to the scout officer to deal with even though the scout officer was already “harassed by many duties attendant upon preparations for an attack that was only three quarters of an hour away.”⁷² Happily, most officers by this point in the war respected the work of intelligence personnel, and did not abuse them in this manner.

Some also believed that the infantry needed more practice carrying out reliefs. It was Hughes’ opinion that battalion scout officers from *other* brigades were somewhat slack, and could have done more to affirm that all relevant records were handed over to his scout officers upon relief. He held that “There is room for a great deal of improvement in this respect in all units of the Corps with which [the brigade came] in contact.”⁷³

⁷⁰ NAC, R.G. 9 III C3, Vol. 4089, Folder 20, File 4. From the 4th Brigade’s “Lessons Derived From the Operation on the Somme.”

⁷¹ NAC, R.G. 9 III C1, Vol. 3843, Folder 44, File 1. 11th Brigade’s “Lessons From the Somme.”

⁷² W.W. Murray, *The History of the 2nd Canadian Battalion (Eastern Ontario Regiment) Canadian Expeditionary Force in the Great War* (Ottawa: Mortimer Ltd., 1947), 123.

⁷³ NAC, R.G. 9 III C3, Vol. 4026, Folder 11, File 3. Report by 1st Brigade on intelligence work carried out at the Somme, October 28, 1916.

The Canadians also saw that further practice with contact air patrols was necessary. The troops often failed to fire their flares to mark their locations for contact air patrol observers out of fear that the Germans, too, would learn their positions and then shell them unmercifully. This was the conclusion of the 50th Battalion. "A possible reason Infantry fail to light flares is because the men have an idea that lighting flares draws fire on themselves. It does to an [extent], and it is difficult to remove this idea, even putting forward the reason that they [the men] will suffer less from that than from a counter-attack."⁷⁴ Problems with contact air patrols, though, were not all of the infantry's making. During the October eighth assault on Regina Trench, a contact patrol reported that units from the 1st Division were on top of their objectives when this was not the case.⁷⁵ More practice was needed by all.

Poor counter battery work was another serious challenge facing the corps, and indeed all belligerents. The destruction of the enemy's trenches and wire still took precedence over silencing enemy guns.⁷⁶ The Somme, though, showed once more that it was the enemy's artillery that was the real target, and that hostile batteries had to be obliterated or neutralized before the infantry could advance across the fire zone to capture and hold ground. Within a minute of launching their assault on October eighth, for example, units from the 9th Brigade were hit by a barrage of German artillery and machine gun fire that inflicted a number of casualties.⁷⁷ Flash spotting and sound ranging, two techniques for locating enemy batteries by measuring and triangulating light and sound waves, were only just

⁷⁴ NAC, R.G. 9 III C1, Vol. 3843, Folder 44, File 1. 50th Battalion report on the Somme.

⁷⁵ Rawling, *Surviving Trench Warfare*, 81.

⁷⁶ Robin Prior and Trevor Wilson, *Command on the Western Front. The Military Career of Sir Henry Rawlinson, 1914-1918* (Oxford: Blackwell Publishers, 1992), 163.

⁷⁷ NAC, R.G. 9 III C1, Vol. 3843, Folder 45, File 4-5. "3rd Canadian Division War Diary Narrative of Operations From 3rd October to 11th October, 1916."

emerging as viable methods for locating enemy guns. Their appearance, however, along with improvements in aerial observation and photographic analysis, announced the arrival of the deep artillery set-piece battle, as they made visible enemy guns and other targets well to the rear of the German front lines. Ultimately, as the Somme battles progressed, the collection and distribution of artillery intelligence became more systematic, and the gunners' response to the needs of the infantry improved.⁷⁸ In 1917 these methods paid dividends, as the artillery could then silence enemy guns before they could harm the assaulting infantry. Unfortunately for the infantry at the Somme, German guns continued to inflict incredible casualties, while wrecking advances and dislodging defenders almost at will.

In the meantime, 1916 ended as did 1915, with the realization that a lack of accurate and timely intelligence hindered battlefield performance. Failures and frustrations on the field reinforced the belief that intelligence played an important role in victory. While intelligence did not win battles by itself, a lack of intelligence, or the possession of inaccurate intelligence, contributed to defeats. However one looked at it, intelligence was proving to be a vital tool in the toolbox. The year also mirrored 1915 in that intelligence personnel, and the intelligence system in general, did not perform as well as hoped, although both were improving. Information flow, although far from perfect, was also developing. The Canadians recognized problem areas, and made efforts to rectify them. This is not to deny that the Canadians did good work at the Somme, but it was in recognizing their failings and weaknesses that they improved. Experience was a great teacher. Indeed, the learning began well before the Canadians left the Somme battlefield. The 4th Division, as we have seen, had benefited from the experiences of the other divisions, incorporating the lessons they had learned into its own operations. In

⁷⁸ Miles, *Military Operations, 1916*, 566 - 567.

effect, the Somme, and Canadian experiences throughout 1916, saw the largely novice and volunteer Canadian Army learning how to win.

CHAPTER EIGHT

INTERLUDE: WINTER 1916 - 1917

Over the winter months of 1916 and 1917, the Canadians evaluated their performance at the Somme. In December 1916, the Canadian Corps' Brigadier-General, General Staff, P. de B. Radcliffe, wrote that "Recent experience has proved that the present organization and training of our Infantry have not succeeded in developing the maximum offensive power bestowed by the weapons with which it is now armed." The Canadians believed there had to be a better way of winning trenches. In order to find that better way the Canadians practiced new platoon assault tactics, based on the principles of fire and movement, and studied how best to use machine guns, trench mortars, and grenades. Radcliffe noted that platoons were now "the largest unit that, under modern conditions, can be directly controlled and manoeuvred under fire by one man." To take advantage of this fact, the Canadians reorganized their platoons and increased their fire-power.¹ The large influx of green troops entering the ranks following the Somme bloodbath also underwent strenuous and realistic training. Intelligence work, its general efficiency and organization, also came under review. In the end, after all the self-examination and reorganization was complete, the corps, along with its intelligence organization, was ready for the 1917 campaign.²

¹ National Archives of Canada (NAC), Record Group (R.G.) 9 III C1, Vol. 3864, Folder 99, File 3. Memorandum by P. de B. Radcliffe, B.G., G.S., December 27, 1916.

² For more detail on the corps' reorganization and training during this period see Bill Rawling's, *Surviving Trench Warfare: Technology and the Canadian Corps, 1914 - 1918* (Toronto: University of Toronto Press, 1992), Chapter Four.

As part of the general reevaluation taking place in the Canadian Corps over the winter months of 1916-1917, General Byng sent General Currie to the French Army to learn what battle-winning techniques the French had discovered in their struggles with the Germans around Verdun. Currie's ensuing report revealed, among other things, his and ultimately the Canadian Corps' solution to the tactical dilemma facing all armies: how to defeat a strong, entrenched, elastic defence, overcome the killing power of concealed machine guns and artillery, defend against the influx of fresh German reserves, and do so without incurring unacceptably high casualties in the process. What he learned mirrored his own thinking on the subject: thorough preparation, which included effective small unit tactics and the wise use of intelligence, was the hallmark of successful operations. He noted, for example, the importance the French placed on reconnaissance and on the attentive study of all available information before committing men to battle.

The divisions chosen for making the attack [he wrote] were sent into the line in order that they might become as familiar as possible with the ground over which they were going to attack. They made the closest possible study of the German defences and considered how every form of resistance that might be expected could be dealt with. Innumerable aeroplane photographs were taken and distributed; every officer and, in fact, every unit commander being given these photographs.

I cannot lay too much stress on the importance attached by the French to this preliminary occupation of the line for reconnaissance purposes. Every man saw the ground over which he would attack; his objective was pointed out to him, as well as the places where he might expect resistance and check.

The French, he saw, prepared plans for defeating all known machine guns and obstacles before the men advanced. Those positions surviving the preliminary bombardment would be silenced by the creeping barrage. "All ranks," Currie wrote, "studied most carefully the best manner of reaching the objective, how

special points of resistance were to be dealt with, and how the objective was to be consolidated.”³

As for the actual collection of intelligence, Currie did “not consider the French Intelligence Department superior” to the Canadian one. The Canadians gathered equally good information, but lagged behind the French in its application. Currie was “struck at the use they [the French] had made of the information gained,” believing they were correct to emphasize the importance of considering all intelligence available for planning operations “in the greatest detail.” In Currie’s estimation, Canadian company commanders did not pay enough attention to intelligence. He pointed out how battalion commanders, too, if they cared to study the most recent intelligence, could calculate the necessary strength of assault waves for securing their objectives and of the mopping up parties. “An intimate knowledge of the enemy, his morale, his strength, his guns and the manner in which he holds his trenches, should be very useful,” he opined. Moreover, Currie felt commanders should not rest contentedly with the information supplied them; instead they “should consider the information [they] should like to have, and if not already in [their] possession, should take steps to secure it.”⁴

Currie also believed the Canadians and British lagged the French in the use of photographs and maps. Photographs, he observed, were “apparently in far greater profusion in the French Army than in ours. I saw some really wonderful oblique photographs. I think we ought to consider whether our facilities for printing, reproducing and distributing photographs can be increased and improved.” Indeed, by the end of 1917, the Canadian Corps, under Byng’s and then Currie’s leadership, distributed mosaic and oblique photographs down to

³ NAC, R.G. 9 III C3, Vol. 4163, Folder 12, File 10. “Notes on French Attacks, North-East of Verdun in October and December, 1916,” by Major General Currie January 23, 1917.

⁴ Ibid.

company commands and individual batteries.⁵ The French map supply was equally inspiring. “For the VERDUN offensive, 190,000 maps, on a scale of 1/5,000 were printed,” with “All commanders of units, even down to the smallest units, [having] one,” a striking comparison to Canadian practice. “In the last sector which the 1st Canadian Division held [wrote Currie], my G.S.O.1 and I had to be content with the same map.”⁶ All told, Currie’s Verdun report provides prescient commentary on the Canadian Corps’ art of attack. And although that art is far too large a topic to cover in this study, it is clear that intelligence work was a vital component. No plan, certainly not one involving a major set-piece attack, could be formulated without an abundance of pre-battle information.

Helping to gather and control that intelligence were the brigade and battalion intelligence sections which, as the Somme had shown, required some improvement. The 1st Division wrote that, “Although much good work has been done by Intelligence Sections during recent tours in the trenches there are still some ways in which more benefit may be obtained from the present organization.” In this light, and as an indication of the importance of battalion level intelligence, some battalion intelligence sections added a second officer to act as an understudy to the battalion scout officer. This was an informal arrangement, but one that gave battalions twenty-four hour a day coverage by an officer devoted to intelligence work.⁷ Record keeping, as well as observation, needed some improvement as well. “In many cases reports...inclined to be vague and inaccurate; they also lack[ed]

⁵ NAC, R.G. 9 III C3, Vol. 4025, Folder 7, File 5. Canadian Corps, December 18, 1917.

⁶ NAC, R.G. 9 III C3, Vol. 4163, Folder 12, File 10. “Notes on French Attacks, North-East of Verdun in October and December, 1916,” by Major General Currie January 23, 1917.

⁷ NAC, R.G. 9 III C3, Vol. 4130, Folder 8, File 1. 6th Brigade to subordinate commands, February 18, 1917; Vol. 4158, Folder 1, File 7. Canadian Corps notes on an intelligence conference held December 13, 1916; R.G. 9 III C4, Vol. 4332, Folder 4, File 10. “Notes on the Instruction of Intelligence Sections,” by 1st Division, December 26, 1916.

continuity.” To improve their reports, observers and snipers began using pre-designed forms that called for specific pieces of information, such as details on the location of the OP, and the bearings of observations made. Observers learned to build simple directors for taking such bearings quickly. Training, too, reemphasized the importance of continuity in observation. Too often, it seemed, observers reported that machine gun emplacements were seen in the forward German trenches when POW statements made it clear that this was unlikely. Unfortunately, the rapidity of battalion reliefs sometimes made continuity in observation difficult to achieve, as observers rotated out of the lines too quickly to learn fully about their surroundings. The 1st Division reminded them that they had to review the reports of out-going observers to make up for the shortage of time. If they did not do this they risked misreading the front. In one case a team of observers reported seeing a sniper loop-hole at a certain point in the enemy line, but the next rotation of observers saw a machine gun post at this same point, while the next team saw a new trench being constructed. This lack of continuity in reporting caused considerable confusion amongst those tracking German trench work activity, and gave a false sense of the German defences.⁸

Intelligence sections also used the winter months to upgrade the skills necessary for working no man’s land. Training emphasized the art of patrolling, with the men learning the three types of patrols: reconnaissance patrols, offensive patrols, and defensive patrols. The reconnaissance patrol was the intelligence sections’ main concern obviously, although offensive patrols were useful for capturing prisoners, while defensive patrols guarded against surprise. Patrol exercises were carried out by day and night. During this training, scouts learned to

⁸ NAC, R.G. 9 III C4, Vol. 4332, Folder 4, File 10. “Notes on the Instruction of Intelligence Sections,” by 1st Division, December 26, 1916; R.G. 9 III C3, Vol. 4158, Folder 1, File 7. Canadian Corps notes on an intelligence conference held December 13, 1916.

judge distances, keep direction in the dark, stealth, and camouflage techniques. Since scouts laid out the tapes that directed assault parties across no man's land, they received additional training in working beyond the wire. Photographic analysis and map reading filled out part of the training syllabus as well. "The importance of [map reading] has been emphasized many times," but the 1st Division felt it necessary "to point out that no man employed on Intelligence Work should be considered competent until he can read a map, give correct locations of distant points, and be able to find his way with its aid." On a related topic, scouts had to possess "The ability to make rough panoramic sketches." This skill was especially useful when reporting on "doubtful objects." Scouts, too, had to learn to "read ground quickly, so that they may be able to select good Sniping and Observation positions in the shortest possible time."⁹ In effect, scouts went through an intensive training programme that recognized the vital nature of their work to operations.

Training also covered liaison work, as intelligence sections formed an important link between the various service arms. "All members of Intelligence Sections must be given practice in reporting targets to the unit which can best deal with them," wrote the 1st Division. "It is of the utmost importance that all Infantry Officers should be kept informed of all movement on their immediate front, and that all suitable targets for Artillery, Trench Mortars and Machine Guns should be reported at once," it added. It was crucial that intelligence officers work closely with FOOs and LOs, and visit artillery OPs daily in order to share information and discuss points of interest to the battalion and the gunners alike. They also met daily with company commanders to ensure that the maximum damage was being inflicted

⁹ NAC, R.G. 9 III C3, Vol. 4158, Folder 1, File 7. Canadian Corps notes on an intelligence conference held December 13, 1916; R.G. 9 III C4, Vol. 4332, Folder 4, File 10. "Notes on the Instruction of Intelligence Sections," by 1st Division, December 26, 1916.

on the German defenders. In the meantime, the division reminded its scouts and scout officers of the importance of sending back news immediately. The belief held by some that so long as information reached divisional headquarters in time for its inclusion in the daily Intelligence Summary was good enough had to end. Delays in forwarding news were unconscionable. Battalion commanders, too, had to give intelligence work their careful attention, because "If our information concerning our enemy is accurate and plentiful then a great step has been gained towards his defeat."¹⁰

In January 1917, around the time that General Currie was distributing his Verdun report, Lieutenant Colonel Andrew McNaughton, soon to be the Canadian Corps' first counter battery staff officer (CBSO) with the forthcoming Counter Battery Office (CBO), was visiting the French Army, and later the British 5th Corps, to learn what he could about the latest counter battery techniques. Unlike Currie, McNaughton was not at all impressed with French methods, stating that "The [French] Counter Battery work although reported to have been most successful, hardly bears close investigation." As for artillery work as a whole, "Nothing that [he] saw or heard in any way [led him] to believe that the French Artillery are using methods superior to ours." He went on to say that "Our Artillery Communications and Observation Posts are very much more thorough than those in use by the French." McNaughton felt the French counter battery effort was disorganized, with each level of command ignorant of the activities of the other.¹¹

¹⁰ NAC, R.G. 9 III C4, Vol. 4332, Folder 4, File 10. "Notes on the Instruction of Intelligence Sections," by 1st Division, December 26, 1916.

¹¹ NAC, Manuscript Group (M.G.) 30 E100 (Currie Papers) Vol. 35, File 160. McNaughton's "Some Artillery Impressions gained during a Visit to the Verdun Battlefields -- January 5th, 6th, 7th and 8th, 1917." General Currie saw the French artillery in a different light. He noted the importance of counter battery fire in French planning, and pointed out that in November 1916 the French field intelligence service located 198 German gun emplacements. This represented over 700 German guns along a ten kilometer front and was, as Currie rightly stated, an obvious indication that that particular sector was of some interest to the German command. Registration of the French counter batteries was carried out with the aid

He returned to the Canadian Corps discouraged over his new role, for counter battery procedures seemed equally ill-defined there, and he was at somewhat of a loss as to what to do. However, after visiting Colonel A.G. Haig at the 5th British Corps (Colonel Haig was Sir Douglas Haig's cousin), McNaughton's mood was buoyed. Haig was responsible for counter battery operations there, and under his initiative the 5th Corps became one of the first formations in the British Army to organize a Counter Battery Office. It was while visiting Haig in January 1917, that McNaughton learned what a Counter Battery Office could truly accomplish, and how the various sources of counter battery intelligence came together, were processed and applied. He saw first hand the "great strides forward" made in aerial reconnaissance, photographic interpretation, flash spotting and sound ranging (this latter technique was entirely new to McNaughton), and how they could pin-point the location of enemy batteries. "After his talks with Haig, he [McNaughton] was to build up a counter battery organization in the Canadian Corps that could not be matched by any similar organization, Allied or enemy."¹²

The creation of a Counter Battery Office was an important development in both the intelligence and artillery war efforts. Indeed, so intertwined are the two that by talking about its benefits to intelligence work it becomes clear how the CBO was also a blessing for the artillery. By 1917, the British had developed a number of techniques for locating hostile batteries, including sound ranging, flash spotting, ground level observation, and aerial reconnaissance. The CBO coordinated, collated and disseminated this information throughout the corps, and fed a

of airplanes and balloons. In the days prior to the French attacks every known or suspected German observation post was targeted for destruction in an effort to disrupt the German command and control system. See R.G. 9 III C3, Vol. 4163, Folder 12, File 10. "Notes on French Attacks, North-East of Verdun in October and December, 1916," by Major General Currie, January 23, 1917.

¹² John Swettenham, *McNaughton, Vol. 1, 1887 - 1939* (Toronto: The Ryerson Press, 1968), 66-74. McNaughton's report on his visit to the 5th Corps can be found in R.G. 9 III C1, Vol. 3922, Folder 7, File 7.

continuous stream of target information to the heavy artillery, to the field guns, and to corps headquarters. The banks of information it compiled gave the CBO a good understanding of conditions along the front, and of the enemy's artillery dispositions; and as the CBO was in tactical control of much of the corps' heavy artillery, hostile batteries and other fleeting targets could be quickly engaged at the CBSO's discretion. This greatly enhanced command versatility, as the corps could now more effectively utilize the guns than was the case previously. This was no small consideration given the artillery's decisive nature. In other words, the CBO, by centralizing the control of artillery intelligence, made better use of that information and, therefore, better use of the guns. Since corps headquarters was in constant communication with the CBO, it, too, was kept well in tune with events at the front. Corps headquarters, in turn, could then keep its subordinate commands better informed and on track than before.¹³

Considering its importance to corps operations, the actual organization of the Counter Battery Office appears rather simple. At its inception it employed just five people. Besides the counter battery staff officer, there was one staff captain (reconnaissance) who assisted with intelligence collation and interpretation, one orderly officer, and two clerks. During the planning stages for the Vimy Ridge offensive (April 1917) these five individuals proved too few in number, so the staff captain(I) serving with the heavy artillery had to help with the counter battery intelligence workload. Two other officers from either the divisional artilleries or the heavy artillery groups assisted the orderly officer with executive work from time to

¹³ For good discussions on the importance of the CBO to both artillery and intelligence work see C.N.F. Broad, "Artillery Intelligence and Counter Battery Work," *Journal of the Royal Artillery* 49.4 and 49.5 (1922 - 1923), 187 - 198 and 221 - 242 respectively; and Albert P. Palazzo, "The British Army's Counter-Battery Staff Office and Control of the Enemy in World War I," *The Journal of Military History* 63.1 (January 1999), 55 - 74.

time, while an additional three clerks brought the clerical staff to five.¹⁴ By war's end, the CBO came to include, in addition to the CBSO, a staff captain (operations), a staff captain (intelligence), two orderly officers, three clerks, two draftsmen, one orderly, and three telephonists.¹⁵ This seemingly simple design belies the true complexity of the Counter Battery Office. The CBSO, for example, was a staff officer of the Corps Artillery commander, yet possessed the status of a heavy artillery group commander. The CBSO was, in effect, a staff officer with command functions. This was, as McNaughton said, "quite an onerous position" to be in, because one "had the tactical running of vast amounts of artillery that were administratively and nominally under the command of somebody else" -- the general officer commanding the heavy artillery -- and one was "not his staff officer."¹⁶ Obviously liaison and cooperation with the heavy artillery had to be as smooth as possible, and to see that it was the CBSO lived at or near the heavy artillery headquarters.¹⁷ Although there were occasional stresses and strains over the use of the heavy batteries between McNaughton and Brigadier-General R.H. Massie, the officer commanding the heavy guns, the arrangement worked well in practice.

As the "Notes on Counter Battery Work in Connection With the Capture of the Vimy Ridge by the Canadian Corps on April 9th 1917" makes clear, information accumulating at the CBO required some system for making it

¹⁴ NAC, R.G. 9 III C1, Vol. 3922, Folder 8, File 3. "Notes on Counter Battery Work in Connection With the Capture of the Vimy Ridge by the Canadian Corps on April 9th 1917."

¹⁵ NAC, R.G. 24, Vol. 1832, Folder GAQ. 8-15e. "Organization and Procedure of Counter Battery Office Canadian Corps Artillery," January 25, 1919.

¹⁶ Swettenham, *McNaughton*, 77. Swettenham's source was a CBC interview with McNaughton on January 17, 1963, conducted for the series "Flanders Fields."

¹⁷ NAC, M.G. 30 E81 (Morrison Papers) Vol. 2, Folder: Artillery Corps: Orders and Instructions 1917 - October 1918. "Status and Duties of the Counter Battery Lieutenant Colonel in a Corps," 1st Army memorandum, February 7, 1917; A.G.L. McNaughton, "Counter Battery Work," *Canadian Defence Quarterly*, 3.4 (July 1926), 380 - 391.

“immediately accessible to the executive officer who is responsible for deciding whether and what action is necessary,” and for automatically recording it “in the most easily accessible form.”¹⁸ To this end, the CBO kept records of both a short and long term nature. Short term records allowed personnel at the Counter Battery Office to locate and respond quickly to news on active enemy batteries. The longer term records provided a history of a given front, and were used to confirm or refute claims regarding the locations of hostile batteries, and to monitor enemy battery activity. In both cases, the CBO kept notes on every single known or suspected hostile battery -- which, of course, amounted to hundreds of enemy guns and gun positions.

The CBO was a hive of activity, and short term records used for fighting enemy batteries on a day-in and day-out basis were always spread out over tables and posted on walls. A 1/10,000 scale map showing the sector occupied by the corps and the enemy opposite was a permanent fixture at the CBO so as to be immediately available for plotting bearings and checking information. On the walls of the Counter Battery Office were maps showing the arcs of fire of friendly guns. Since these arcs changed as gun barrels wore out, each week the artillery sent battery reports to the CBO indicating the expected new range of each gun; it was these expectations that were recorded on the wall map. If there was a large number of friendly guns to monitor, the CBO used portfolio maps with easily turned pages instead -- one map for each battery group, for instance. Chalk boards were also popular for recording various lists. One list might show friendly batteries out of action during a given day, while another might be used to record daily enemy battery activity. Thus, the day's activity was visible at a glance. At the end of each day CBO staff used this information to prepare various reports that they

¹⁸ NAC, R.G. 9 III C1, Vol. 3922, Folder 8, File 3. “Notes on Counter Battery Work in Connection With the Capture of Vimy Ridge by the Canadian Corps on April 9th, 1917.”

then distributed throughout the corps as needed. Another method used to monitor enemy battery activity was to mark with pins the location of each hostile battery on a map. "Every day a battery is active a coloured ring or little disc of coloured paper is put over the pin, a different colour being used for each day of the week. The week's activity can then be seen at a glance."¹⁹ In a similar way, coloured chalk was used to record the landing spot of each hostile shell. New colours were used every three or four months or after any redistribution of the hostile artillery facing the corps. This map showed in an instant the areas habitually shelled by the Germans, and allowed planners to calculate the approximate arcs of fire for each hostile battery.²⁰ In this way the limits of German artillery responses to Canadian actions could be calculated in advance. In whatever manner the information was recorded, "Too much stress cannot be laid on the importance of having everything clearly represented pictorially. There is no time for hunting about in books," as one memorandum related.²¹

In addition to these short term records, which by their temporary nature did not survive the war, the CBO maintained a number of medium to long term records. For example, special maps (suspect maps) and file cards (suspect cards) were used to record information on the location and activity of all unconfirmed hostile batteries (HBs). Each map square had its own suspect card on which the intelligence officer recorded all activity occurring in that area. Each unconfirmed battery also had its own identifying number. Once "the Intelligence Officer considers that there is sufficient evidence to 'confirm' the H.B., the case is submitted to the C.B.S.O., who is the final authority in deciding whether or not a position should be

¹⁹ NAC, R.G. 9, III C1, Vol. 3922, Folder 7, File 9. "Notes on the Work of a Counter Battery Office."

²⁰ NAC, R.G. 24, Vol. 1832, Folder GAQ. 8-15e. "Organization and Procedure of Counter Battery Office Canadian Corps Artillery," January 25, 1919.

²¹ NAC, R.G. 9, III C1, Vol. 3922, Folder 7, File 9. "Notes on the Work of a Counter Battery Office."

confirmed.” The CBSO required reports from at least two “entirely different sources” before confirming hostile battery locations. Once confirmed the hostile battery was assigned a new number, prefixed by the letters of the map square and sub-square in which the battery lay.²² As well, the CBO maintained a record sheet for each confirmed hostile battery, and recorded all activity associated with that HB. It also listed the file numbers for any airplane photographs in which the HB was visible, and commentary on the effectiveness of counter battery fire against that position. On the reverse side of the record sheet was a map drawn to approximately 1/80,000 scale showing the corps’ area of operations. On this map the CBO plotted the hostile battery’s location, and showed the exact direction the battery faced. The CBO also kept maps and lists of areas each hostile battery shelled. Knowing what particular enemy batteries shelled which areas of the front let planners calculate possible enemy artillery responses to friendly moves. Moreover, by monitoring enemy shelling patterns, Allied commanders learned something of the Germans’ offensive capabilities in a given area.²³

The intelligence officer at the CBO also prepared a Daily Artillery Intelligence Report (DAIR). Its function was similar to the intelligence summaries discussed in earlier chapters, and presented short term information accrued in the preceding twenty-four hour period. The DAIR returned to the various counter battery groups and batteries that same night or early the next morning all

²² Army command assigned a range of numbers to each corps to be used for tracking HBs in its area. The problem with this system was that when corps shifted position they sometimes assigned numbers to batteries previously counted by the out-going corps. This meant some HBs ended up with two or more numbers, considerably confusing matters. Prefixing the numbers with map square and sub-square letters helped identify duplicates. R.G. 9 III C1, Vol. 3920, Folder 2, File 7. “Report on Conference of C.B.S.O’s with R.F.C., Army Intelligence, and Staff Officers R.A., 1st Army at CHOCQUES,” February 21, 1917.

²³ NAC, R.G. 9 III C2, Vol. 3922, Folder 8, File 3. “Notes on Counter Battery Work in Connection With the Capture of the Vimy Ridge by the Canadian Corps on April 9th 1917;” R.G. 9, III C1, Vol. 3922, Folder 7, File 9. “Notes on the Work of a Counter Battery Office.”

consequential information collected, and did so in a "digested form." The DAIR was in two parts. The first covered all new information on enemy hostile batteries active along the corps' front, with listings for confirmed hostile batteries. The second section included information on hostile batteries operating along the corps' flanks. Interestingly, and as a reflection of the managerial skills associated with information control, the CBSO described the DAIR in accounting terms. The DAIR, he said, was "the 'cash book' of Counter Battery Intelligence," or "the book of first entry, while the Records Sheets were akin to ledgers."²⁴

A number of other reports were issued by the Counter Battery Office. The cumbersomely titled "Programme of Pre-arranged Destructive Shoots on H.B's with Observation by the R.F.C." was issued nightly, and outlined the friendly counter battery agenda for the upcoming twenty-four hour period. The "Report on Aeroplane Shoots" presented counter battery activity "as seen from the Battery's standpoint...side by side with the Airman's report" of what they saw. This was an extremely valuable report because airmen and gunners could not always meet face to face to discuss the day's work and compare notes. "The report therefore forms in many cases the only medium for exchange of views," and was considered by McNaughton to have materially increased the success rate of Canadian counter battery fire. The "Weekly Report on Hostile Battery Activity" was issued every Thursday to corps headquarters, and "contained general notes on the attitude of the enemy's artillery opposite the Corps front, the numbers and calibres of H.B's which have been active, grouped as far as possible by hostile formations, and comparisons with the results shown during the preceding week, with deductions, if any, to be drawn." A second "Weekly Report on Hostile Batteries," prepared for

²⁴ NAC, R.G. 9 III C2, Vol. 3922, Folder 8, File 3. "Notes on Counter Battery Work in Connection With the Capture of the Vimy Ridge by the Canadian Corps on April 9th 1917;" also R.G. 24, Vol. 1832, Folder GAQ 8-15e. "Organization and Procedure of the Counter Battery Office Canadian Corps Artillery," January 25, 1919.

the Counter Battery Office's own use, was a compilation of all information contained in Part I of the DAIR for the preceding week. There was also the "List of Hostile Batteries" report. This was issued about every four days to artillery groups, batteries, and the divisional artilleries, and contained the numbers and coordinates of all confirmed batteries in the corps and flanking areas.²⁵

As time passed, the CBO adjusted the records it kept -- new ones were prepared and old ones dropped as the situation warranted in order to more efficiently track hostile batteries. Activity maps, for instance, were later introduced to display graphically the enemy's battery activity at a glance. These maps showed all the hostile batteries known to be operating in the corps' and flanking HB areas. New maps were issued weekly and maintained daily. All confirmed and active hostile batteries (as reported on the DAIR) were marked with a small square, and if the guns' calibres were known, the square was filled in with coloured ink (different colours denoting distinct calibres). Knowing the calibre of a gun gave McNaughton its range, which told the CBO what targets it was capable of hitting. In addition, each active hostile battery was marked with a small circle. These, too, were filled with variously coloured inks, with each colour representing a different source of intelligence. The colour used depended on which source discovered the battery first. Coloured triangles were also utilized to record the type of activity associated with the battery. One colour represented destructive shoots, another concentrations, and another gas bombardments.²⁶ This map proved useful for

²⁵ NAC, R.G. 9, III C2, Vol. 3922, Folder 8, File 3. "Notes on Counter Battery Work in Connection With the Capture of the Vimy Ridge by the Canadian Corps on April 9th 1917."

²⁶ Destructive shoots were bombardments fired against known positions with the aid of an observer. According to McNaughton, "The object to be attained is primarily the destruction of material." It began with an intense burst of fire designed to catch enemy gunners in the open, before they could get to cover. Concentrations, meanwhile, were intensive destructive shoots carried out against enemy batteries when poor visibility or other causes prevented these shoots being observed. A number of batteries were employed to compensate for individual

gaining a quick understanding of the enemy's battery activity, capabilities, and habits.²⁷ During the more fluid fighting of 1918, fewer long term records were necessary. One post war document pointed out that while record sheets were essential under trench warfare conditions, "they are a useless encumbrance during Moving Warfare."²⁸

As already noted, counter battery intelligence revealed more about the enemy's position than just the location of his hostile batteries. Inferences could be made on the aggressiveness of the opposing forces. Defensive positions were indicated, for example, when the bulk of the enemy's fire was of a harassing

gunnery errors. The direction of fire was based on previous registration or predicted fire.

Registration is the process of determining the correct targeting information necessary for hitting a target in the future. It requires an observer to call in the necessary adjustments to the fall of shot if the gunners do not have a direct line of sight to the target for themselves.

Predicted fire -- or firing from the map -- is indirect fire without the aid of an observer. It uses map coordinates as a guide. Obviously the exact position of the enemy target is required, as are the exact coordinates of friendly batteries. Survey teams supplied this data. Targeting information is then calculated using map bearings, and adjusted for weather, gun wear, winds, etc. Predicted fire does away with the need for registration and, therefore, retains the element of surprise, unlike registration.

Another form of artillery fire was neutralization. This, wrote McNaughton, was "an expedient to paralyse the active hostile batteries by subjecting them to intense bursts of shell fire. It [was] employed in the offensive to protect the infantry while they [were] advancing to their objectives by bringing fire to bear on every H.B. known or suspected which [had] not previously been destroyed. At all times every A[ctive] H[ostile] B[attery] definitely located should be neutralized." Neutralization also inflicted casualties and caused a deterioration in enemy morale, for whenever the enemy fired their guns they knew to expect retaliation. See A.G.L. McNaughton, "Counter Battery Work," *Canadian Defence Quarterly* 3.4 (July 1926), 387 - 388.

²⁷ NAC, R.G. 9 III C1, Vol. 3920, Folder 2, File 8. "Counter Battery Office Canadian Corps Artillery," May 1918; R.G. 9 III C3, Vol. 4148, Folder 13, File 2. Order No. 77, Appendix G, "Duties of Counter Battery Adjutants with Heavy Artillery Groups," summer 1918.

²⁸ NAC, R.G. 9 III C1, Vol. 3922, Folder 7, File 9. Cover letter to "Notes on the Work of a Counter Battery Office," dated December 9, 1918, by Lieutenant Colonel Crerar, CBSO.

nature, and came from guns positioned well to the rear of the enemy lines.²⁹ Batteries distributed in depth and well positioned for covering troop withdrawals was another defensive posture. There also tended to be a marked decrease in the number of guns firing from a defensive position compared to more aggressive sectors, and there was often a discernible change in the calibre of those guns that did fire. Offensive positions were recognized by the cessation of heavy artillery activity, and an increase in registrations. Large explosions behind the enemy's lines resulting from friendly counter battery fire destroying enemy ammunition dumps proliferating in anticipation of an assault was another sign of aggression. The number of gun pits, and the forward movement of enemy guns all pointed to increased aggressiveness.³⁰ Shelling maps, gun ranges, and the arcs of fire of enemy guns were all valuable for determining what front the Germans were preparing to assault. When combined with other intelligence, such as maps tracking enemy raid activity, aerial observer flight paths, wireless traffic, and POW statements, the location, nature and arcs of fire of enemy guns presented a fair means for assessing enemy intentions and capabilities for any given location. Indeed, the CBO was such a useful intelligence centre that prior to the Canadians' assault on Vimy Ridge (April 1917) Lieutenant-General Julian Byng, the corps commander, was a frequent visitor, while Radcliffe, and other corps staff officers, practically lived there.³¹

The CBO was also intimately connected to the communications grid that

²⁹ McNaughton described harassing fire in the following way. "Harassing fire should consist of short intense bursts at irregular intervals directed on centres of activity, billeting areas, railway stations, road junctions, bridges, etc. In fact on any place where the enemy may be expected to be in vulnerable formation." It was valuable for inflicting casualties, lowering the enemy's morale, and blocking routes of approach. McNaughton, "Counter Battery Work," 387 - 388. Machine guns and trench mortars also took part in harassing fire programs.

³⁰ McNaughton, "Counter Battery Work," 387 - 388.

³¹ Swettenham, *McNaughton*, 74-75.

criss-crossed the front by 1917, and it was this that allowed it to almost immediately respond to events at the front. As Figure 8.1: "Counter Battery Office Intelligence, 1917-1918" illustrates, the CBO's intelligence network reached beyond the internal intelligence sources inherent in the Canadian Corps, meaning the CBO, and therefore Canadian Corps headquarters, was normally well informed. Its communication centre was stocked with telephones and wireless sets, firmly linking it to sound rangers, flash spotters, the corps squadron, and to all the intelligence sources used by the various artillery and infantry formations throughout the corps. Through these channels, urgent information concerning HBs and other targets quickly reached the CBO report centre. Once there the CBSO and his staff checked it against the stacks of information available, and then dispersed it across the front to the intended users. For instance, if a report on an active hostile battery reached the CBO, and that HB was seen to be firing from a position previously unknown, then word of its firing was sent out to sound rangers, flash spotters and to the corps squadron. These teams then trained their attention on the area of the reported firing. If the enemy gun remained active there was a good chance its location would be discovered by one or more of these sources. From there the necessary counter battery response was made. Similarly, if the enemy battery location was already known, then counter battery fire could be quickly called down, although it was not always necessary, or even advisable to engage enemy batteries each time they fired. Such aggressiveness might force the enemy to relocate, forcing the intelligence organization to search for them all over again. It might also be more important at the time to conceal the location of friendly batteries than to reveal their positions in order to silence enemy guns. In other words, it was sometimes best to simply leave enemy batteries alone, plot their location, and neutralize them when necessary, such as during a friendly advance.

Figure 8.1: Counter Battery Office Intelligence, 1917 - 1918

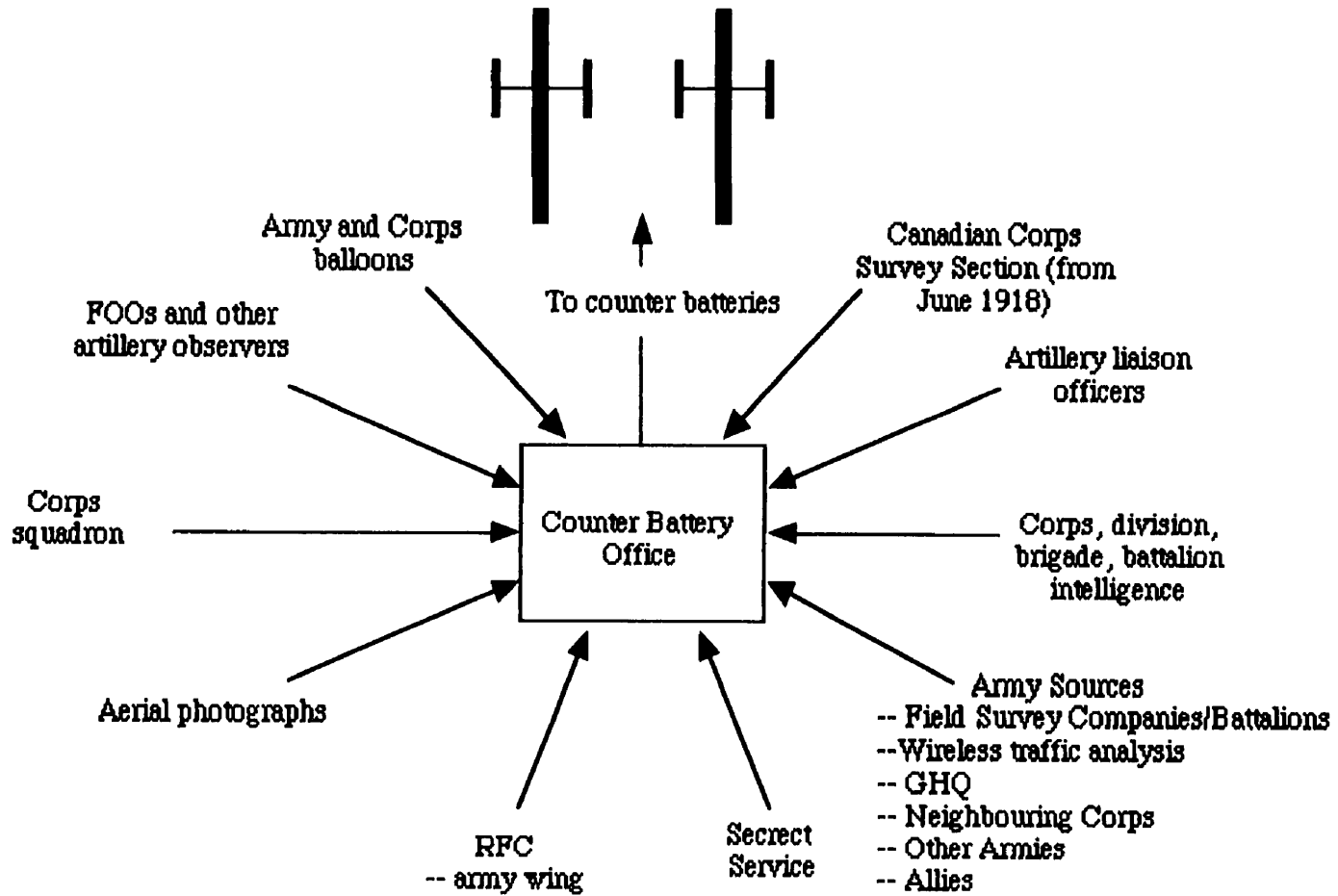

In December 1916, GHQ introduced Branch Intelligence Sections to each corps squadron in order to squeeze more information out of the RFC. Its effects only began to be felt in 1917 and beyond. Until that time, squadron commanders collected observation reports from their pilots and observers, and forwarded the information to their respective corps headquarters for evaluation. Squadron leaders did not make evaluations themselves because they did not possess the requisite non-aerial intelligence stock-piles to allow them to assess the validity of claims made by their observers. Neither did squadrons possess an organization for systematically interpreting aerial photographs. With the adoption of Branch Intelligence Sections, however, squadrons came into intimate contact with officers and men capable of evaluating intelligence gathered by pilots and observers. Branch Intelligence Sections consisted of one intelligence officer seconded from the British Intelligence Corps, two draftsmen from the Field Survey Companies, one clerk and one orderly. These teams lived with their respective squadrons in order to maintain personal contact with the pilots and observers whose individual idiosyncrasies and skills the intelligence officer took into consideration when evaluating their observation reports. It was a duty of these intelligence officers to personally interrogate all returning pilots and observers in order to ensure that complete tactical details were collected and forwarded to corps headquarters, with important discoveries immediately telegraphed to the army, corps, heavy artillery, or division concerned. Meanwhile, the various corps headquarters kept their particular Branch Intelligence Section informed of their aerial intelligence requirements, with the intelligence officer in turn passing these requests on to the pilots and observers. Branch Intelligence Sections were also capable of interpreting aerial photographs, and maintained a filing system for quick retrieval of every photograph taken. In addition, at least in the Canadian Corps, both the artillery and the Counter Battery Office placed liaison officers at squadron headquarters to maintain personal contact

and familiarity. Through these means information flowed more smoothly between corps headquarters and the flyers, and fostered a closer working relationship -- one that was further enhanced through daily contacts between the intelligence officer of the Branch Intelligence Section and officers of the heavy artillery and the Counter Battery Office. Weekly corps-level intelligence conferences, where officers met face-to-face, added to the cooperative atmosphere.³²

After the Somme, GHQ also approved the addition of artillery reconnaissance officers to the artillery organization. This formalized an arrangement many commands were practicing since mid 1916. These posts were created in response to the need for greater control over artillery intelligence in division-sized and higher artillery formations. Divisional artilleries, the corps' heavy artillery and the Counter Battery Office each had its own reconnaissance officer, as did the corps' General Officer Commanding the Royal Artillery. Reconnaissance officers handled the intelligence duties in their respective commands, which included the preparation of the daily artillery Intelligence Summary and other sundry maps and reports. They also maintained personal contact with the various providers of information. In the case of the CBO, these sources included sound rangers and flash spotters working in the corps area. Reconnaissance officers also monitored wire cutting programs, and new enemy work projects and movements. Further, they observed the effectiveness of destructive shoots to ensure that obstacles were sufficiently removed from the path

³² NAC, R.G. 9 III B1, Vol. 942, Vol. E-114-3. "Extension Of The Present Intelligence System So As To Afford Closer Co-operation With The Royal Flying Corps," 1st Army instructions, December 20, 1916; R.G. 9 III C3, Vol. 4152, Folder 15, File 2. Canadian Corps "Intelligence Instructions," March 3, 1918; J.E. Hahn, *The Intelligence Service Within the Canadian Corps 1914-1918* (Toronto: Macmillan Company of Canada, Limited, 1930), 258-263; Christopher Andrew, *Secret Service: The Making of the British Intelligence Community* (London: Sphere Books, 1984), 209.

of the infantry, and saw to it that artillery intelligence was properly disseminated to the intended users.³³

Beginning in 1917, the British began placing an Intelligence Corps officer in each division to assist with intelligence work. This meant Canadian divisions now employed three officers on intelligence duties: the GSO2(I), the GSO3(I), and the Intelligence Corps officer attached. The responsibilities of the new position were many, and included quick examinations of POWs for immediate tactical information (corps continued to be the main centre for prisoner interrogation, although divisions took on a greater role with the arrival of this officer), keeping in touch with brigades during operations and assisting them with their intelligence needs, supervising the up-keep and distribution of maps and photographs, assisting with photographic interpretation, helping to maintain the various intelligence records at division, disseminating findings to subordinate commands, and aiding in the preparation of the daily divisional Intelligence Summary. In effect, these officers handled a great deal of the office work, thereby allowing the GSO2(I) and the GSO3(I) to concentrate on trench work.³⁴

Standardized procedures were essential for controlling the mass of information generated and accumulated by the Canadian Corps, and in 1917 corps headquarters pushed uniformity on all levels of command. Managerial proficiency

³³ NAC, R.G. 9 III C3, Vol. 4095, Folder 35, File 4. GHQ memorandum on the duties of reconnaissance officers, March 9, 1918. The creation of artillery reconnaissance officers was authorized in a GHQ letter No. O.B./1911 of January 13, 1917. Hahn, *The Intelligence Service*, 140. Appendix Vd: "Royal Artillery, Canadian Corps, March 3, 1919," in the *Report of the Ministry, Overseas Military Forces of Canada* (London, 1919), does not show artillery reconnaissance officers in the artillery organization, it refers to these officers as staff captains(I). See the chart in the *Report* following page 240.

³⁴ NAC, M.G. 30 E61 (Mitchell Papers) Vol. 13, Folder 89. 2nd Army memorandum on the duties of divisional intelligence corps officers, April 7, 1917. Although the Canadians were not under the 2nd Army at this time, they did start to employ intelligence corps officers in divisions that year, and their duties were no doubt similar to those laid out in this memorandum. Also, Hahn, *The Intelligence Service*, 115.

was crucial to the effective use of intelligence, for information that was lost, improperly recorded, or forgotten was useless. Corps and divisional headquarters were anxious to reap the maximum benefit from intelligence so dearly harvested by men risking their lives in the field. Lectures and guidelines, two mediums for enlightening officers and other ranks on the importance of intelligence to winning the war, were put to use to spread this message.³⁵ The chief sniping instructor from the Canadian Corps Scouting, Sniping and Observation School, for example, gave a series of lectures at various battalion settings designed to reinforce these very ideas.³⁶ Other officers gave similar addresses. The 3rd Battalion heard two lectures by a visiting officer that emphasized the importance of transmitting clearly stated and accurately collected information. In a note to the battalion commander he wrote:

In large bodies of troops, with each Battalion maintaining an Intelligence Section there is no doubt but that a great deal of valuable information is lost or never reaches an authority where its value can be accurately appraised, through lack of a simple method of recording the information in a suitable and intelligible form for forwarding. Valuable opportunities may thus be lost, both from the standpoint of military operations, but also in regard to the credit and prestige that might otherwise be secured for the unit concerned.³⁷

Schools were another avenue for instructing officers and men in the art and value of intelligence. Besides the corps and divisional schools described in the previous chapter, other specialty schools opened. The 11th Brigade opened an intelligence school in June 1917, run by Captain F.J. O'Leary under the personal supervision of Brigadier-General Victor Odlum, the brigade commander. It is not

³⁵ NAC, R.G. 9 III C3, Vol. 4224, Folder 6, File 13. Canadian Corps to the 4th Division, December 26, 1917.

³⁶ NAC, R.G. 24, Vol. 1840, Folder: G-A-Q 10-37. "Canadian Corps Scouting[,] Sniping & Observation School," no date, likely early post war.

³⁷ NAC, R.G. 9 III C3, Vol. 4074, Folder 1, File 10. Lieutenant Colonel W.A. Lowry to the Officer commanding the 3rd Battalion, January 6, 1917.

clear if any other brigades organized similar schools, or if this school continued beyond its first class, but it certainly represents Odlum's profound belief in the efficacy of intelligence in winning trench warfare. Odlum had long been a believer in the value of intelligence, and commanded the 7th Battalion when that unit organized the Canadian Corps' first large scale raid in November 1915 at the Douve River. The school offered a twelve day course with a curriculum that covered every conceivable aspect of brigade and battalion intelligence work, including the organization of the enemy army, map reading and construction, photographic analysis, handling prisoners of war, liaison, scout work, intercommunication, reconnaissance work, patrols and observation, and commentary on the various sources of information available across a corps and army front. On the thirteenth day an examination tested the attendees' skills.³⁸

Intelligence conferences offered an additional forum for spreading the intelligence message, and such conferences became increasingly common in 1917. This was especially the case when the Canadians were planning large operations like the assault on Vimy Ridge, when daily intelligence conferences were the norm. Brigades held their own conferences under the supervision of staff captains(I), attended by officers commanding machine gun companies and stokes mortar batteries, and by artillery liaison officers and battalion scout officers. At a conference held by the 6th Brigade in February 1917, topics discussed included a debate on the ideal strength of battalion scout sections, the duties of battalion and company scouts, the need to absolutely dominate no man's land, the use of Lewis guns and other equipment on patrols, the duty of battalion scout sections during a raid and in the advance, the need for constant observation, and proper report

³⁸ NAC, M.G. 30 E 300 (Odlum Papers) Vol. 20, Folder: Training, 11th Brigade, July 1917. "11th Canadian Infantry Brigade. Syllabus of Instruction -- Twelve Day Course -- Under Personal Supervision of G.O.C.," June 28, 1917.

writing. Divisions, too, held daily meetings for similar purposes.³⁹ In addition to hashing out procedures, the attending officers discussed the importance of the latest intelligence to Canadian operations, and set targets and intelligence gathering objectives for the next day. During normal trench warfare, when active operations were not pending, weekly conferences were typical. Corps headquarters hosted its own conferences, thereby spreading the standardization message far and wide, while facilitating the sharing of information on a corps-wide scale.

Standardized message forms also proliferated in 1917. These were pre-printed forms of a 'fill-in-the-blank,' and 'select-one-of-the-following responses' nature designed to secure for rear area commanders the utmost detail with the minimum amount of writing by those forwarding the information. Blank forms were issued down to platoons, and seem to have been first used by the Canadians at Vimy Ridge, although earlier battles saw efforts to ease message writing through the use of pre-printed sketch maps, as occurred at the Somme. Message forms were used only in active operations, and solely to carry information from the front to the rear. Therefore, they did not help solve the problems associated with the forward flow of information. Pre-printed forms, while ensuring that soldiers at the front recorded the most salient information (such as the time the message was sent, the location of the sender, and specifics on the immediate situation), also reminded officers that details concerning circumstances at the front were constantly required in the rear.⁴⁰ Surprisingly, some officers failed to see the need to inform the rear of the situation at the front in an on-going way.⁴¹ During the Vimy Ridge operation,

³⁹ NAC, R.G. 9 III C3, Vol. 4083, Folder 2, File 5. Second Division to subordinate commands, March 17, 1917; Vol. 4135, Folder 22, File 4. "Notes of a Conference of Scout Officers, 6th Canadian Infantry Brigade, held February 3rd, 1917."

⁴⁰ NAC, R.G. 9 III C3, Vol. 4158, Folder 1, File 14. Memorandum on use of message forms with an example, 7th Brigade's staff captain(I) to units, March 1, 1917.

⁴¹ NAC, R.G. 9 III C3, Vol. 4014, Folder 25, File 2. Operation Order No. 212, 2nd Brigade, July 24, 1917.

for instance, the 1st Division noticed that some “Units are inclined to underestimate the value of reports on the enemy’s movements or defences during a battle.” In some units “It is frequently considered that such reports very soon become out of date and of little value consequently they are not forwarded [to brigade or division], but the aggregate of such reports often furnishes valuable information regarding the enemy’s dispositions and intention.”⁴² Obviously, some officers remained deaf to the calls for more information during a fight.

Over the winter months the corps adopted and developed techniques and organizations that it hoped would help them win against an entrenched enemy. The Canadians practiced small unit tactics, enhanced unit fire-power, and reorganized their platoons to take advantage of these improvements.⁴³ Intelligence collection and transmission was an important part of this general reevaluation. Through the CBO, for example, the corps enjoyed an improved flow of artillery intelligence, which helped improve the gunners’ performance. As the artillery was now the decisive arm, these changes were welcomed. Meanwhile, standardized reports and new intelligence positions made it clear that the Canadians (as with other imperial commands) attached great importance to field intelligence work, and were struggling to find ways to improve information flow during actions. Their next battle, the assault on Vimy Ridge, would tell the tale.

⁴² NAC, R.G. 9 III C3, Vol. 4050, Folder 16, File 18. “Notes on Intelligence in Recent Operations,” 1st Division, May 1, 1917.

⁴³ Rawling, *Surviving Trench Warfare*, Chapter Four.

CHAPTER NINE

VIMY RIDGE AND HILL 70: APRIL - AUGUST 1917

The Canadian Corps continued to wield the intelligence sledgehammer in 1917 to help knock the Germans out of carefully prepared and heavily defended positions. That the intelligence collected was of the highest order was thanks to experience gained in 1916. The set-piece attacks it helped create were large and complex undertakings that consumed an impressive amount of high quality intelligence. These plans, rehearsed until all ranks inherently knew their assigned tasks, timed to the minute, and coupled to improved small unit tactics and fire-power, reduced battlefield confusion and helped commanders control the action. If communications had been more reliable, such detailed and centralized planning would have been less imperative; but with the brittle communications system then in use, commanders, particularly battalion commanders, could not control the action in a direct manner. To compensate, the Canadians utilized the highly structured plans and time-table tactics people have come to associate with World War One set-piece attacks. In effect, 1917 saw commanders trying to control the battle before the battle to a far greater degree than previously. This necessitated the need for large amounts of precise pre-battle intelligence.

The Battle of Vimy Ridge, beginning on April 9, 1917, consumed an enormous amount of intelligence for both planning purposes and for command and control reasons. The Vimy operation was part of the larger British Arras Offensive carried out by the Third British Army. The Canadian Corps, then in the First

Army, advanced to secure the ridge to protect the Third Army's left flank.¹ Taking the ridge was easier said than done. It was 475 feet above sea level and, being the dominant feature in the area, gave its German defenders a wide and clear view of the Canadian lines lying below its gently rising slopes. The Germans could see everything that transpired in the Canadian sector. The ridge was, therefore, of immense tactical importance. Adding to the difficulties of attacking up hill was the fact that the ridge blocked the Canadian view of the German defences lying beyond its crest and on the reverse slope; and as the Germans had held the ridge since 1914, there remained plenty of natural cover on the far side in which to screen artillery, infantry, and supplies. Moreover, the Germans had turned the ridge into a fortress, something the French had learned the hard way in previous years.

The German defenders relied on a rigid defence to hold the heavily cratered hill, rather than on the more elastic defence in depth then being practiced by other German commands elsewhere on the Western Front. Their defences were composed of three main lines. The first line, on the ridge itself, consisted of three rows of trenches some 700 yards deep, and were covered by machine guns and protected by wire. Deep dug-outs, impervious to even the largest calibre guns, housed the defending units. Behind the ridge, and running roughly parallel to it, was a second line lying some 600 to 1,000 yards beyond the forward line. It, too, had deep dug-outs, some able to accommodate whole battalions, strongly entrenched machine guns, and thick belts of wire covering its front. The second line generally conformed to the Canadians' final objective. Well behind this position was a third defensive line. It lay up to five miles behind the first line. Artillery covered these positions, and were poised to destroy any and all attackers.²

¹ Jonathan Nicholls, *Cheerful Sacrifice. The Battle of Arras 1917* (London: Leo Cooper, 1990), 27.

² Jeffery Williams, *Byng of Vimy. General and Governor General* (Leo Cooper, 1983; reprint, Toronto: University of Toronto Press, 1992), 149 - 150.

The Canadians knew the strength of the German defence, and prepared accordingly. Intelligence work was a vital part of that preparation. The Canadian Corps, as we have seen, now incorporated a Counter Battery Office whose purpose was to locate hidden guns. The corps also employed an extensive system of ground and air observation that was able to collect incredible detail on German defensive positions. The 16th Squadron, RFC, attached to the Canadian Corps, had been working in the area for some time, and “knew every foot of the front, and of the German rear areas, opposed to the Canadians.”³ Intelligence secured through aerial photographs and raids added to the intelligence profile the Canadians were building. Twelve tunnels extended from the Canadian position out into no man’s land, and provided protective cover to the attacking troops at the outset of the attack, as well as to the delicate communications system constructed prior to the advance. Canadian tactics, too, had improved since the Somme. Platoon tactics, based on the principles of fire and movement, were the order of the day, and these were more effective than the linear assault waves of previous years at infiltrating between and behind strong points in order to take them in the flanks and rear. This, combined with increased fire-power at the unit level, meant assaulting Canadian troops had a far better chance of securing their objectives than in years past. Moreover, the recent introduction of the 106 fuse for high explosive shells meant gunners could now more effectively cut wire entanglements than was the case when using shrapnel. Finally, the number of guns available to the Canadians during the operation -- 480 eighteen-pounders, 138 4.5-inch howitzers, 245 heavy guns and howitzers, plus an additional 132 heavy guns and 102 field guns available from the First Army should they be needed -- helped pulverize the German defences.⁴

³ Syd Wise to author, February 14, 1999.

⁴ Williams, *Byng*, 151 - 152; G.W.L. Nicholson, *Official History of the Canadian Army in the First World War: Canadian Expeditionary Force, 1914-1919* (Ottawa: Queen’s Printer and Controller of Stationary, 1962), 249.

Indeed, the Canadian assault on April ninth was an enormous success. The Canadians secured most of their objectives on the first day. With the exception of the fighting around the Pimple and Hill 145, the assault went exactly to time-table. On April twelfth, the Canadians took the Pimple, the last of their objectives. The cost of the battle was heavy as 10,602 officers and men became casualties -- 3,598 of them fatal -- but the ridge was captured, and the Canadian Corps' reputation assured.⁵ In the aftermath, the Germans had to relinquish several more miles of ground in order to occupy a more defensible line. Vimy Ridge remained in Allied hands until the end of the war.

Plans for the assault, which would see all four Canadian divisions attacking at the same time, were meticulously prepared. Intelligence gathering took weeks to complete.⁶ A measure of the effort involved can be seen in the 1st Division's preparation of a 1/2,500 scale map of its sector that it up-dated each day. This map was in addition to all the army issued maps also available to the Canadians. The 1/2,500 scale map, however, was far more detailed, showing all the German trenches along with their German names (obtained from a captured map), all known trench mortar and machine gun emplacements, dugouts, observation posts, and so on. Airplane photographs and ground observation also proved valuable for accumulating this detail. According to the division "This Map was subsequently proved to be very accurate and was of immense value to all Units." It was also

⁵ Compared to earlier French Army efforts to take the ridge the Canadian losses were relatively light. In 1915, the French lost well over 100,000 men in futile assaults.

⁶ National Archives of Canada (NAC), Record Group (R.G.) 9 III C4, Vol. 4342, Folder 4, File 11. 7th Brigade's "Information regarding German Signal Service," April 2, 1917, for example, describes the intelligence required for mapping the German communications system. Its simple description belies the enormity of the task. The 7th Brigade wrote: "Thus, summarizing the...information, it has been possible to work out the German system of telephonic communication right from the front line to Regimental and Divisional Headquarters, and this is one of the most valuable items of information required for our operations. Their destruction will seriously inconvenience the enemy."

used to prepare a full scale practice course taped out over ground approximating that over which the Canadians assaulted. On this practice ground

Every trench was shown by tape and flag, numerous 'Name Boards' being put up showing the German name; trench mortar emplacements and machine gun emplacements, Battalion, Company, and Signalling Headquarters were all marked on the ground. All Units, Infantry, Engineers, and F.O.Os. that were to go over in the attack were practiced in turn, and in conjunction with each other over this Course....

In addition...a Plasticine Model on a Scale of 1/5,000 was prepared for the Division by an Intelligence Officer at the First Army Headquarters, assisted by a Draughtsman of the Division. This Model was set up in a Hall at Divisional Headquarters and studied by all ranks, Artillery, Machine Gunners and Infantry.⁷

Captain James Belton and Lieutenant E.G Odell, in their book *Hunting the Hun*, recalled: "When we reached our training areas, we saw hundreds of yards of white tapes two inches wide, stretched out before us. These tapes represented to us the outline of the German trenches which we were to attack and capture on Vimy Ridge. They lay on the ground in exactly the same position that we would later find the German trenches."⁸ Each division made similar preparations.

The training course was of enormous help to assaulting troops as they struggled to find ways of defeating the enemy, and in overcoming the confusion of battle. Models helped planners work out the movements of the assaulting troops. General Currie stated that the training over the taped course meant that "every individual taking part in the attack knew his place and what was expected of him and was one of the main factors which ensured success of the operation." Since all ranks knew their tasks intimately, during the advance the men could carry on to

⁷ NAC, Manuscript Group (M.G.) 30 E 15 (Griesbach Papers) Vol. 3, Folder 19. "1st Canadian Division Report on the Vimy Ridge -- Willerval -- Arleux and Fresnoy Operations April 9th -- May 5th 1917."

⁸ Captain James Belton and Lt. E.G Odell, *Hunting the Hun* (NY: Appleton & company, 1918), 27.

their objectives even when most of their officers became casualties.⁹ The 3rd Division agreed, stating that with only one exception

all the objectives were gained and consolidated, with comparatively slight loss, in practically the identical manner and time that had been... repeatedly practiced over a facsimile of the trenches. Every man and Machine Gun arrived in the appointed place, there was no loss of direction, and the consolidation of the advanced posts and defensive line was carried out precisely as practiced.¹⁰

The 3rd Brigade reported:

The extraordinary success that the operation met with, running as it did absolutely to time-table, emphasized the value of the training received; the artillery preparation and co-operation, and the individual self confidence of every man. Officers and Non-commissioned Officers recognized the ground, and found that what the Intelligence had told them that they might expect to find in the way of dugouts, trench mortar emplacements, machine gun emplacements, etc., etc., they most certainly did find.¹¹

The 4th Battalion could not have agreed more, stating:

It is impossible to exaggerate the advantage of [previous observation and intelligence to the victory]. Without the careful training or the laid out ground, and the time available for detailed explanation to all ranks, followed by a few days in the trenches permitting of personal observation by every Officer and man, it is difficult to believe that the advance would have gone as smoothly as it did.

The Intelligence supplied as to the German dispositions, particularly the Aeroplane photos, proved most accurate and valuable.¹²

⁹ NAC, M.G. 30 E 15 (Griesbach Papers) Vol. 3, Folder 19. "1st Canadian Division Report on the Vimy Ridge -- Willerval -- Arleux and Fresnoy Operations April 9th -- May 5th 1917."

¹⁰ NAC, R.G. 9 III C3, Vol. 4146, Folder 9, File 2. 3rd Canadian Division to Canadian Corps, May 5, 1917.

¹¹ NAC, M.G. 30 E 236 (Villiers Papers) Vol. 3, Folder 5. 3rd Brigade's "Report on Operations, Battle of Vimy Ridge, April 9th, 1917."

¹² NAC, R.G. 9 III C3, Vol. 4026, Folder 11, File 6. 4th Battalion to 1st Brigade, April 16, 1917.

Currie, when summarizing his commands' role in the battle, made this assessment of the intelligence contribution:

The data had been very carefully arranged by the Intelligence Branch of the Division and proved very accurate and reliable. This fact enabled targets of real value to be engaged by the Heavy Artillery with the best results and the minimum expenditure of ammunition compatible with the task. The accurate location of dugouts taken from a study of aeroplane photographs was of great value in selecting positions of Battalion Headquarters and Advanced Report Centres as the advance progressed.

The intelligence gained of the habits of the enemy so as to enable us to harass him with the greatest result, and the accurate information gained of the area over which we had to attack was, I consider, one of the main causes of our success.¹³

Similar praise for intelligence work was recounted in the other units and formations.¹⁴

As a number of the above quotations make clear, the proper use of intelligence and detailed planning reduced command and control difficulties, as commanders made most of their serious decisions before the battle started. This meant that troops learned by rote in the days and weeks prior to the offensive how and when to reach their objectives. Chance and luck dwindled as pre-calculations, based on up to the minute intelligence, dissipated much of the fog and confusion of war. The 1st Brigade declared that "All ranks must be catechized until they know and thoroughly understand the intention, the tactical situation, [the] allotment of

¹³ NAC, M.G. 30 E15 (Griesbach Papers) Vol. 3, Folder 19. "Report on Operations Carried Out By The 1st Canadian Division. April 9th - May 5th 1917."

¹⁴ See for example, R.G. 9 III C3, Vol. 4146, Folder 9, File 2. "Report on Operations of the 7th Canadian Infantry Brigade in the Attack on Vimy Ridge From S.22.b.45.17 to S.29.a.55.90, From April 9th to April 12th 1917." In Vol. 4051, Folder 19, File 2. "Summary of Operations From April 9th to April 20th, 1917," the 15th Battalion wrote: "The training over the COURSE helped a great deal and the men knew where they were going and the ground layout very well." In addition to these two commands, a number of other battalions prepared reports describing the activities of their intelligence sections throughout the operation. The 13th, 14th, 15th and 16th Battalion reports, for example, can be found in Vol. 4010, Folder 12, File 5.

duties,” and the details of the plan.¹⁵ The 78th Battalion offers a case in point as to how detailed these plans could be. The movements of its companies were timed to the minute: At sixty minutes before Zero Hour the troops were to begin arriving at the jump-off trenches; at thirty minutes before Zero all were to be in position; at Zero the advance was to begin; seventeen minutes later ‘C’ and ‘D’ Companies were “to take up sheltered position behind [specified] craters;” twelve minutes after that ‘A’ and ‘B’ Companies were to “take objectives and commence consolidation;” at forty-five minutes past Zero ‘C’ and ‘D’ Companies would move forward, followed at Zero plus seventy-nine minutes by their taking, and consolidating, their assigned objectives.¹⁶ There was no margin here for delay, or for unforeseen difficulties; it was all matter-of-fact, and precisely pre-calculated.

As suggested in Currie’s comments presented earlier, the artillery plan was equally exact, and dependent upon good intelligence for success. Staffs prepared maps and diagrams for the gunners, showing them their tasks in detail, wire to be cut, defences to be demolished, routes to be employed by artillery in movement, signal communications to use, the location of artillery OPs, and myriad other details.¹⁷ Artillery fire concentrated on important points in the enemy position, such as trench junctions, machine gun emplacements, hostile batteries, routes of approach, and so on. The 1st Division reminded its infantry that close touch with LOs and FOOs was essential for taking advantage of opportunity targets. “No targets should be allowed to escape unmolested.” Sniper guns were available for just that purpose.¹⁸ The Canadians also prepared march tables that showed the

¹⁵ NAC, M.G. 30 E15 (Griesbach Papers) Vol. 3, Folder 16(A). 1st Brigade “Notes for the Guidance of Battalion Offices During Operations,” April 4, 1917.

¹⁶ NAC, R.G. 9 III C3, Vol. 4237, Folder 3, File 3. 78th Battalion Operation Order No. 63.

¹⁷ NAC, M.G. 30 E100 (Currie Papers) Vol. 48. *Artillery Notes* (S.S. 139/4), February 1917.

¹⁸ NAC, R.G. 9 III C3, Vol. 4046, Folder 4, File 2. 1st Division to Brigades, March 17, 1917. These were guns designated to fire at opportunity targets.

expected times of arrival of German reserves at certain points. After action reports agreed that artillery intelligence had been thorough. Major-General L.J. Lipsett, commanding the 3rd Division, praised the target maps prepared by his division's intelligence staff. Through a careful study of the available intelligence "The elaborate system of German defence was accurately plotted and grouped into targets which were systematically engaged. The result was that all German Strong Points and Machine Gun Emplacements were gradually destroyed."¹⁹ The RFC deserves its share of the credit for the success of the artillery plan. Prior to the assault it photographed the entire German defensive system, and these photographs helped up-date maps, and locate enemy batteries.²⁰

Part of the softening-up of the German defences on Vimy Ridge included continuous harassing fire by the artillery and trench mortars. The Canadian Corps' "Artillery Plan for the Capture of Vimy Ridge" announced that

Throughout the hours of darkness during the main preliminary bombardment all the known lines of approach to the front system of trenches will be kept under constant harassing fire of considerable intensity; no [German] reliefs, or ration or ammunition parties

¹⁹ NAC, R.G. 9 III C3, Vol. 4146, Folder 9, File 2. 3rd Canadian Division to Canadian Corps, May 5, 1917. There were a number of maps developed for the plan. Map 'T' was of the "main system of hostile defences to be engaged, showing those portions requiring aeroplane observation, ground observation, and doubtful ground observation." Map 'U' showed the main points in the German defence requiring special attention. Map 'S' showed "the main system of German wire and nature of projectile required for engaging the various lines." Map 'P' showed "the main tracks, communications, approaches, light railways, refilling points, dumps, etc." Map 'M' was the barrage map. A 'Trench Destruction Map' was also periodically issued that estimated the "general degree of destruction." See R.G. 9, III C3, Vol. 4089, Folder 21, File 1. Canadian Corps "Artillery Instructions for the Capture of Vimy Ridge."

²⁰ S.F. Wise, *Canadian Airmen and the First World War. The Official History of the Royal Canadian Air Force, Vol. 1* (University of Toronto Press, 1981), 401; M.G. 30 E15 (Griesbach Papers) Vol. 3, Folder 19. "Report on Operations Carried Out By The 1st Canadian Division. April 9th -- May 5th 1917." This report reads in part: "The 16th Squadron, R.F.C., rendered most valuable assistance in registering for our Artillery and carrying out photographic reconnaissances, in spite of the adverse weather conditions and interference from the latest pattern German Machines, which caused them many casualties."

should be able to reach the front line without suffering heavily; heavy guns should also search the rearward approaches, and refilling points etc. with special attention to the approaches to all known hostile battery positions.²¹

This fire, as with all other artillery fire, was not haphazardly applied, but was based on the careful study of intelligence. Yet so silent is the role of intelligence that it is easy to forget that none of what this statement asked the gunners to do was possible if intelligence officers, sound rangers, flash spotters, pilots, ground observers, scouts and FOOs were not constantly on alert, and collecting and compiling information on the German line.

Prisoners of war, and captured documents supplied valuable information as well. The notes from one conference, for example, stated that the Canadians needed prisoners because POWs know the routes into the trenches, the locations of battalion and company headquarters, and the position of billeting areas. "All of these things are of immense importance to us as targets for our Artillery. By harassing the enemy now in every possible way, he will be half-beaten before the Infantry 'attack.'" A captured map, meanwhile, gave the Canadians the location of many of the German battalion and regimental headquarters.²²

Machine guns from the divisional and brigade machine gun companies, and from the Canadian Corps Motor Machine Gun Brigade, added to the harassment by bringing to bear the "greatest possible volume" of fire, both day and night, on a number of different targets. These included enemy wire "in order to prevent repairs and hinder new work," and specific communication trenches, roads, tracks, tramways, and dumps (especially those leading to trench mortar emplacements).

²¹ NAC, R.G. 9 III C3, Vol. 4026, Folder 11, File 4. "Artillery Plan for the Capture of Vimy Ridge."

²² NAC, R.G. 9 III C3, Vol. 4007. Notes from a March 30, 1917 conference held at Canadian Corps H.Q; R.G. 9 III C4, Vol. 4342, Folder 4, File 11. 7th Brigade's "Information regarding German Signal Service," April 2, 1917.

Massed machine gun fire also helped thicken the rolling and defensive barrages laid down by the artillery and trench mortars on the day of assault. During the actual advance, machine gun batteries moved forward to pre-selected positions as part of the larger plan; from there they supported the infantry and took on opportunity targets.²³

The counter battery intelligence effort was equally prodigious. During the ten days before the attack, counter battery fire was ceaseless. The CBSO targeted all known and active hostile batteries for immediate destruction, except for those known to be collected into groups or nests; these, being more easily neutralized than isolated batteries spread across the front, were destroyed in the hours just prior to Zero. The exception to the exception was when enemy batteries were particularly pernicious to friendly infantry -- they were silenced forthwith. The Canadian Corps' "Artillery Plan for the Capture of Vimy Ridge," noted that "A very effective method of neutralizing the hostile artillery is to destroy their telephone exchanges...at the latest possible moment before the attack is launched." In a similar way the destruction of enemy OPs was "reserved to the latest possible moment." Such action disrupted enemy communications and observation at the critical moment of attack. Obviously, HBs, telephone exchanges, and OPs had to be located beforehand.²⁴ In the end, thanks to the efforts of sound rangers, flash spotters, other ground observers, and No. 16 Squadron attached to the corps, eighty-three percent of the estimated 212 German batteries threatening the Canadian

²³ NAC, R.G. 9 III C1, Vol. 3885, Folder 32, File 3. "Canadian Corps. Scheme of Operations." Machine gun batteries contained eight guns; two or more batteries made a group. To help facilitate liaison with the infantry, group commanders either worked out of the brigade battle headquarters of the brigade they were supporting, or from the headquarters of one of the battalions of the brigade. At Zero Hour on April ninth, group commanders were connected to their batteries by buried cable. As they advanced during the assault, flares and runners were used. Telephone connections were reestablished as soon as possible thereafter.

²⁴ NAC, R.G. 9 III C3, Vol. 4026, Folder 11, File 4. "Artillery Plan for the Capture of Vimy Ridge."

Corps were located and targeted -- effectively mastering the German guns. Indeed, at one point, along the 2nd Division's front, there was no German artillery response for seven minutes as the troops crossed no man's land.²⁵ Hundreds of lives were no doubt saved. Moreover, throughout the action the CBO was on full alert, and ready to inform the heavy and field artilleries of any reported active hostile batteries, or of massing enemy troops, or of some other fleeting target.

As successful as the counter battery fire was at Vimy, McNaughton felt more could be done in the future. He was disappointed that the German guns hidden in woods behind the ridge went undisclosed.²⁶ He determined to do better next time, and in June 1917, reported that "The Artillery Intelligence System is well developed in the Corps and the situation of the Active Hostile Batteries known with considerable precision. We feel confident therefore that a sound choice of targets is being made, and that this end of the work [i.e. intelligence] is not a factor limiting efficiency."²⁷

Once the assault on Vimy was underway, intelligence collection continued. Commanders in the rear needed to know what conditions were like at the front, and other details on the progress of the advance, before they could effectively commit their reserves, take advantage of opportunities, engage fleeting targets, and shell enemy defences holding up the advance. To ensure that these important details reached rear area commanders, the Canadians set up an elaborate

²⁵ John Marteinson et al, *We Stand On Guard. An Illustrated History of the Canadian Army* (Montreal: Ovale Publications, 1992), 158. The fact that No. 16 Squadron was increased from eighteen to twenty-four aircraft surely helped the Canadian counter battery intelligence effort. S.F. Wise to author, May 25, 1999.

²⁶ John Swettenham, *McNaughton, Vol. 1, 1887 - 1939* (Toronto: The Ryerson Press, 1968), 90 - 92; G.W.L. Nicholson, *The Gunners of Canada. The History of the Royal Regiment of Canadian Artillery, Vol. 1, 1534 - 1919* (Toronto: McClelland & Stewart, 1967), 282.

²⁷ NAC, M.G. 30 E100 (Currie Papers) Vol. 35, File 160. McNaughton memorandum regarding "Counter Battery Office Canadian Corps Artillery," June 25, 1917.

communications system that used all the latest technologies. In the air, contact air patrols flew overhead at pre-set times, and called on the infantry (by blasting Klaxon Horns) to mark their positions by firing flares or shining lights. Ground sheets laid out at various forward headquarters were also used to convey messages to pilots (differing patterns denoting different messages). Pilots noted the message, recorded the infantry's position on maps, and dropped the news in message bags at drop zones located at divisional and corps headquarters further to the rear. Some aircraft used wireless, and could report their observations to ground stations immediately. This was particularly important for securing a rapid response against fleeting targets. Aerial observers also watched for German troop movements and hostile batteries in areas out of sight to ground observers, and their contributions to the Canadian victory are given due credit in Canadian battle reports. The RFC, in short, helped restore battlefield immediacy to commanders further back which, in turn, improved their ability to command and control the action.

While the pilots flew overhead, an intricate system of report centres and observation posts was in operation on the ground. This system collected and transmitted news from the front to commanders in the rear. When battalions advanced, for example, many arranged for a special team, comprised of their scout officer, scouts, runners and signallers (carrying various signalling apparatus, including pigeons), to follow behind the last assault wave, and make for pre-selected points in the captured enemy line (usually a dugout or a trench) where they constructed report centres and OPs. The 2nd Division wrote prior to Vimy:

The principle on which Battalions should work is to have a central Report Station established as soon as objectives are reached. It should be the duty of the Intelligence or Scout Officer to collect and communicate all messages received from his Observers and Company Officers, to the O.C. and in addition, to transmit the

information to flanking units and Brigade, according to their urgency and the means of communication available.²⁸

On their way to these forward points, and depending upon distances covered and the difficulty of the terrain, the scout officers established runner relay stations in order to shorten the distance that runners had to travel to deliver messages. Once at their assigned positions the signallers accompanying the report centre teams, and using the various communications apparatus they carried forward, began relaying news on the front line situation as directed by the scout officer to commanders waiting anxiously in the rear. Since report centres were built in the newly captured lines and amongst the fighting troops, company commanders and others could contact these centres with news if they could not maintain touch with the rear for themselves. Meantime, the scouts established observation posts along the captured line, collected details on events unfolding across the battalion front, and attempted to locate the new enemy position. This information was then sent through the battalion report centre back to brigade OPs watching for signals from the front, and to battalion headquarters. A description by the 4th Battalion illustrates something of how this procedure worked.

When the Battalion advanced on the morning of April 9th. the Scout Section moved in rear of the left leading company. This formation was adhered [sic] to until a previously selected point...was reached. There an observation post was established from which messages were sent back to Battalion Headquarters concerning all movements of our own and enemy's troops, reports on hostile artillery and our own barrage. This information was transmitted by a station of signallers attached to the Scout Section [working at the report centre].²⁹

²⁸ NAC, R.G. 9 III C3, Vol. 4088, Folder 16, File 2. 2nd Division to subordinate commands, February 24, 1917.

²⁹ NAC, R.G. 9 III C3, Vol. 4010, Folder 12, File 5. 4th Battalion "Report on part taken by Scouts in the Recent Operations. Apr. 9th. & 10th."

Eventually, the information reached brigade headquarters through brigade OPs and report centres, and ultimately the parent division and corps HQ (or the supporting artillery if the information concerned artillery targets). As soon as practicable, usually during the first night, the telephone lines running overland up to the battalion report centres were securely buried underground.³⁰ Once the fighting settled down, or as a new stage in the advance was reached, battalion report centres became the new battalion HQs. If a further advance was made, and a new report centre was required, the report centre teams repeated the process until the lines stabilized once again, or the attack ran out of steam, in a kind of leap-frog fashion. In effect, the use of report centres more efficiently managed information flow during an advance, as battalion signallers concentrated on maintaining communications from one main point, rather than dissipating their efforts by trying to keep up communications across the entire battalion front. At the same time, the scout observers working with the report centres gave close observation of the action, and fed up to the minute reports on the fighting to commanders in the rear. Since the men in the permanent brigade and battalion OPs knew the approximate location of these forward report centres beforehand, observers watching for signals at these posts had their job made easier by knowing where to look.³¹ The report

³⁰ NAC, M.G. 30 E 236 (Villiers Papers) Folder 5. "Instructions for the Offensive 3rd Canadian Infantry Brigade;" R.G. 9 III C3, Vol. 4010, Folder 12, File 5. Reports by the 1st, 2nd, 3rd, 4th, 5th, 7th, 8th, 10th, 13th, 14th, 15th and 16th Battalions, May 1917. Also Vol. 4051, Folder 19, File 2. "Report of 2nd Canadian Infantry Brigade Action April 9th 1917. Capture of the Enemy's Positions on Vimy Ridge and Subsequent Operations April 10th to 20th, 1917;" R.G. 9 III C1, Vol. 3885, Folder 32, File 3. "Canadian Corps. Scheme of Operations."

³¹ NAC, R.G. 9 III C3, Vol. 4010, Folder 12, File 5. Reports by the 13th, 14th, 15th, 16th Battalions on the work of intelligence sections during the Vimy Ridge operation. In addition to building report centres, and gathering pre-battle and battle intelligence, the 14th Battalion reported that its scouts were important for regulating the movement of the assault waves, "holding troops from advancing too fast and entering our own barrage, and upon reaching the Black Objective they helped to reorganize the waves."

centre system also saved telephone cable and other precious signalling equipment, as fewer lines and signal posts were necessary.³²

Post action reports made it clear that these advanced report and observation centres were valuable for relaying information. The 27th Battalion recorded how the OPs built by its scouts in the new position “kept Battalion Headquarters informed as to the enemy’s movements,” and that “these O.P’s supplied valuable information.”³³ The 42nd Battalion concurred: “The services of the Intelligence Section were invaluable in gathering and forwarding information to [Battalion] Headquarters.”³⁴ The Princess Patricia’s Canadian Light Infantry (PPCLI) made

³² The Canadian action at Vimy Ridge was not the first time the Canadians used report centres. Canadian battalions used an early form of report centre in 1916. These earlier report centres, however, were not necessarily under scout officer control. Instead signallers, following each advancing company, built signal stations on captured ground (meaning that each battalion sometimes tried to maintain two or more signal stations). This practice, of course, spread signal personnel thin on the ground, and complicated the task of maintaining communications. In February 1917, the 2nd Division found that the location of such signal-controlled report centres and relay stations were “very often in positions which are known only to the Signallers, and far from positions which are suitable for Observation Posts.” The solution, as already described, was to place intelligence officers in charge of report centres. Interestingly, the 28th Battalion, in November 1916, called for “a special party detailed to follow the attack, [and] report on positions reached and the general situation.” Indeed, many battalions in the 4th Division were building report centres at the Somme along the lines described above. See R.G. 9 III C3, Vol. 4139, Folder 7, File 6. 28th Battalion’s lessons on the Somme; Vol. 4088, Folder 16, File 2. 2nd Division to subordinate commands, February 24, 1917; Vol. 4035, Folder 6, File 6. 2nd Battalion Operation Order No. 25; and M.G. 30 E5 (Bovey Papers) Vol. 4. Operation Order No. [80], September 13, 1916; R.G. 9 III C1, Vol. 3843, Folder 44, File 1. 75th Battalion’s “Lessons from the Somme.” Infantry brigades used report centres too. There were some growing pains, naturally, but the system worked well. In September 1916, the 3rd Brigade reported that “The establishment of a Forward Report Centre, controlled by the Brigade Intelligence Officer, was found to be of the greatest value; when the system is thoroughly understood and is fully developed, it will be found to be a great economizer of time, and will ensure the proper dissemination of information in the right quarter.” See R.G. 9 III C3, Vol. 4011, Folder 17, File 4. 3rd Brigade to 1st Division, September 13, 1916. Also Vol. 3843, Folder 44, File 1. 10th Brigade to 4th Division, December 20, 1916.

³³ NAC, R.G. 9 III C3, Vol. 4135, Folder 22, File 4. 27th Battalion’s report on the workings of the scout section during the Vimy Ridge operations, May 22, 1917.

³⁴ NAC, R.G. 9 III C3, Vol. 4153, Folder 5, File 3. 42nd Battalion to 7th Brigade, May 19, 1917.

similar claims: "When Final Objectives had been reached, Battn. scouts moved forward, and manned two O.Ps. in the captured positions. From these posts continuous observation of the enemy was maintained during the day-light, until the Battalion was relieved."³⁵

Commands behind battalions pushed forward their own report centres. Brigade centres were established by either brigade signal officers, or staff captains(I), leading teams of scouts and signallers in a manner similar to battalions. Brigade centres were normally built in close proximity to battalion centres in order to facilitate information exchange, and had all the usual signalling apparatus on hand (power buzzers, pigeons, runners, wireless sets, telephones, Fullerphones, and ground sheets), and so could receive and transmit information from any source. If not at their report centre, staff captains(I) were likely at their brigades' principal OP with the brigade observers, gathering and transmitting information on events and enemy counter attacks from there, or at their brigades' headquarters gathering information from the front using telephones arranged especially for their use. In a similar way, divisions, corps and armies established advanced centres for collecting and relaying news, thereby facilitating the exchange of information at those levels.

Some brigade intelligence officers also built advanced OPs during attacks. On April tenth, the 2nd Brigade's scouts moved forward after the front stabilized, and established observation posts in more commanding terrain. During the attacks on April twenty-eighth at Fresnoy, the staff captain(I) led two teams forward for similar reasons. One post "although subjected to heavy shelling, kept Headquarters in constant touch with the progress of the attack, very important reports being

³⁵ NAC, R.G. 9 III C3, Vol. 4153, Folder 5, File 3. Princess Patricia's Canadian Light Infantry (PPCLI) to 7th Brigade, May 22, 1917. Similar praise can be found in Vol. 4010, Folder 12, File 5. Reports by the 13th, 14th, 15th, 16th Battalions on the work of intelligence sections during the Vimy Ridge operation.

constantly sent in with regard to enemy concentrations.” Reports from these forward OPs “together with Battalion Reports, enabled Brigade Headquarters to be in constant touch with the situation, and thust [sic] enabled the Artillery to accomplish most effective work in breaking up enemy concentrations for a counter attack, in force.”³⁶ Battles, of course, remained confusing affairs, but through planning and well thought out communication schemes, rear area commanders retained some semblance of control over the action at the front.

In addition to report centres and OPs, other groups of men made their way forward to observe and report on the fighting. Battalion scouts not with the report centre teams, for example, carried out special reconnaissances on behalf of their battalion commanders, such as clarifying particularly confusing situations. Various brigade and battalion officers also reconnoitred the lines as required. The 1st Brigade advised that “As soon as the situation permits (not recklessly) every officer up to battalion commanders and brigade staff will make a personal reconnaissance of his area, discover the situation and dispositions, and report in writing.”³⁷ Observers also watched the action from the more permanent observation posts constructed by battalions and brigades during normal trench warfare. These were well equipped, concealed positions with telephone links to their respective headquarters. They operated throughout the advance, and provided quick and reliable information on the progress of the fighting. One of their tasks was to watch for light signals sent by the advancing tanks using ALDIS Lamps. This was an

³⁶ NAC, R.G. 9 III C3, Vol. 4050, Folder 16, File 18. “Report Upon 2nd Canadian Infantry Brigade Intelligence Section During, and Leading up to, Offensive Operations From 9th April 1917, to 28th April 1917;” R.G. 9 III C1, Vol. 3885, Folder 32, File 3. “Canadian Corps. Scheme of Operations;” Vol. 4138, Folder 5, File 6. “Preliminary Instructions for the Offensive No. 3,” March 1917; M.G. 30 E15 (Griesbach Papers) Vol. 3, Folder 19. “Report on Operations Carried Out By The 1st Canadian Division. April 9th -- May 5th 1917.” Staff captains(I) also organized parties to search enemy dugouts for documents and maps.

³⁷ NAC, R.G. 9 III C3, Vol. 4033, Folder 4, File 5. “Notes for the Guidance of Battalion Officers During Operations,” 1st Canadian Brigade, April 4, 1917.

important task, for as the 6th Brigade noted, this was the only signals arrangement in place between the tanks and the infantry.³⁸ All were in agreement as to the value of OPs. They were regularly credited with providing commanders with up to the minute information, and were a highly valued component of the information network. After the Vimy operation the 42nd Battalion wrote: "In general the Battalion O.P. with phone communication well repaid the work spent on it."³⁹ The 2nd Brigade stated that "All the [brigade] Observation Posts were in communication by telephone with Brigade Headquarters...Signallers for visual work were also attached to each observation post. From Zero Hour onwards, a complete detailed report of the progress of the attack was received at Brigade Headquarters."⁴⁰

The use of report centres and observation posts allowed for an orderly flow of trustworthy news. The 3rd Brigade proclaimed:

Beyond this [system as described above], it is impossible to lay down in detail what should be done, but once this point is reached [i.e. the system is in place], the main difficulty of keeping communications across what was 'No Man's Land' is very largely overcome, and the Intelligence Officer is in the position of having trained men to obtain information, and the best means possible in the circumstances of sending it back. The rest must depend upon himself.

Moreover, the 3rd Brigade believed that since brigade and battalion OPs and report centres were all interconnected, they helped coordinate the all-arms battle. It wrote that the above described system should be used "In order to secure the greatest co-

³⁸ NAC, R.G. 9 III C3, Vol. 4138, Folder 5, File 6. "Instructions for the Offensive No. 4," April 6, 1917.

³⁹ NAC, R.G. 9 III C3, Vol. 4153, Folder 5, File 3. 42nd Battalion to 7th Brigade, May 19, 1917.

⁴⁰ NAC, R.G. 9 III C3, Vol. 4010, Folder 12, File 5. "Report Upon 2nd Canadian Infantry Brigade Intelligence Section During, and Leading up to, Offensive Operations From 9th April 1917 to 28th April 1917," May 17, 1917. The 4th Brigade also noted that communications were maintained throughout, and a good idea of the battle's progress always available. See Vol. 4105, Folder 19, File 9. 4th Brigade's report on Vimy Ridge.

operation between the Signal Sections and between battalion Intelligence Sections, Brigade Artillery F.O.O.'s, [and] Machine Gun Companies.”⁴¹

While the infantry were building their communications, FOOs advancing with them were feeding information to the gunners regarding events at the front, including news on the massing of enemy troops and other targets of opportunity. The ridge itself, once in Canadian hands, was expected to “afford excellent observation.” Forward observation parties from both the divisional and heavy artilleries tried to take advantage of the heights. The ridge was especially important for counter battery work, for “Direct observation on hostile batteries [was] certain to be obtained” from its summit. Signalmen ran cables up to the FOO posts on the ridge as soon as possible. In the 3rd Division, FOOs accompanied the first wave of the assault and established OPs near the division’s final objective, where “they were of great assistance to the Infantry.”⁴² There they worked in pairs; one remained at the OP, the other worked outside collecting information from the surrounding infantry. Using runners, the outside FOO sent whatever news he gathered back to the FOO stationed in the OP who relayed it to the rear.⁴³

Liaison officers, stationed at various headquarters, assisted with the transmission of news. Artillery LOs working with the infantry were particularly valuable, helping battalion and brigade commanders secure gun support, and for passing information between the two service arms. Ideally, artillery brigades established their headquarters next to the infantry brigade headquarters they were

⁴¹ NAC, R.G. 9 III C3, Vol. 4105, Folder 19, File 9. 3rd Brigade’s “Instructions for the Offensive,” March 30, 1917. The Machine Gun Company supporting the 3rd Brigade had its own report centre, which it established near the centre attacking battalion’s report centre. From there, the machine gun report centre communicated with the brigade report centre by visual signal.

⁴² NAC, R.G. 9 III C3, Vol. 4146, Folder 9, File 2. 3rd Canadian Division to Canadian Corps, May 5, 1917; Vol. 4089, Folder 21, File 1. Canadian Corps “Artillery Instructions for the Capture of Vimy Ridge.”

⁴³ NAC, R.G. 9 III C1, Vol. 3843, Folder 46, File 4. “Notes on Artillery Preparation and Support of the Attack on Vimy Ridge.”

supporting, but when that was not possible, liaison officers were used (both the heavy and divisional artilleries had LOs with infantry brigades). Meantime, recording officers -- essentially LOs -- were at the headquarters of the attacking battalions. Their main duty was to "gather all possible information from Infantry Reports, and to transmit such information to their Artillery Brigades...They will, further, investigate and report on cases of short-shooting." The divisional and heavy artillery also exchanged liaison officers. So important was the role of artillery liaison for maintaining gun support that the corps wanted the most senior artillery officers available used in that capacity. Junior and inexperienced officers, no matter what their rank, were not to take on liaison tasks.⁴⁴ Other supporting arms made similar arrangements. To facilitate the sharing of information between Machine Gun Companies and the infantry, for example, machine gun group commanders worked from infantry brigade battle headquarters, or out of battalion HQs. Telephones connected them to their batteries up until the action started, then they used flares and runners. As soon as possible thereafter, telephone connections were made again.⁴⁵ Neighbouring battalions and brigades exchanged officers as well, and in this way the assaulting infantry kept in touch with events on their flanks. The efforts of these, and all LOs, was appreciated. The 15th Battalion held that the artillery LO assigned to it "was of great assistance especially in stopping a Battery which was firing short." The battalion made little use of the infantry LOs, though, mainly because the assault went so smoothly. Had snags occurred, the battalion thought these LOs would have been of greater use. As it was, the

⁴⁴ NAC, R.G. 9, III C3, Vol. 4089, Folder 21, File 1. Canadian Corps "Artillery Instructions for the Capture of Vimy Ridge." Also Vol. 4067, Folder 4, File 1. GHQ's "Duties of Observation Officers, Forward Observation Officers, Liaison Officers, and Forward Liaison Officers," issued at least as early as April 2, 1917.

⁴⁵ NAC, R.G. 9 III C3, Vol. 4011, Folder 18, File 1. "Canadian Corps Scheme of Operations Part I (Tactical)," no date. Also Vol. 4138, Folder 5, File 6. "Instructions for the Offensive No. 2 Machine Gun Scheme," February 27, 1917.

battalion was always in touch with its flanks, and seldom out of touch with its brigade.⁴⁶

In fact, most commanders during the Vimy operation remained well in touch with events along their portion of front. But even had they lost touch they could count on their subordinates to carry the job through, as plans bound men and machines to specific actions, movements, and schedules. The quantity of high quality intelligence collected for planning purposes had let the Canadians pre-calculate the actions thought necessary to secure victory, while the communications and intelligence arrangements in place during the battle kept commanders in touch with events as they unfolded. The ability to remain in control of the situation goes a long way to explain the Canadian Corps' success at Vimy Ridge.

Not long after the Vimy Ridge offensive, General Byng was promoted to command the British Third Army. Replacing him as head of the Canadian Corps was General Currie who, like Byng, was a meticulous planner. His first major operation as corps commander occurred on August 15, 1917 against Hill 70 near the industrial city of Lens. The Hill 70 operation was designed to divert attention away from the larger British offensive known as the Third Battle of Ypres, begun on July thirty-first near Passchendaele. The British wanted the Canadians to keep as many German formations engaged as possible so as to prevent their reinforcing the Ypres sector. Originally, Field Marshal Sir Douglas Haig, the commander of the BEF, instructed the Canadian Corps to take the city of Lens. Currie, on personal investigation, counselled against this, believing an attack on Lens meant almost certain defeat. The problem, as Currie saw it, was that Lens was dominated

⁴⁶ NAC, R.G. 9 III C3, Vol. 4051, Folder 19, File 2. "Summary of Operations From April 9th to April 20th, 1917," by the 15th Battalion. Further references for liaison arrangements can be found in Vol. 4105, Folder 19, File 9. The 3rd Brigade's "Instructions for the Offensive," March 30, 1917; Vol. 4138, Folder 5, File 6. "Instructions for the Offensive No. 3. Appendix D," and 6th Brigade's "Instructions for the Offensive No. 4," April 6, 1917."

by two hills: Hill 70 and Sallaumines Hill, and so long as both were strongly held by the Germans, any Canadian gains in Lens would be untenable. Moreover, the Germans had trenches running throughout the city, and these were defended by hundreds of machine guns.⁴⁷ Rather than assault Lens, Currie believed that Hill 70 offered a more suitable objective. Its capture would put the Canadians on the dominant terrain, and allow them to threaten the Germans in Lens, rather than the other way around. "If we have to fight at all," Currie said, "let us fight for something worth having." Taking the hill and the surrounding area would not be easy, however. The hill offered little cover for assaulting troops, while the city and its environs, having been reduced to rubble, made for ideal defensive cover for the Germans. In addition, slag from the Lens mining operations covered the area and made the footing treacherous. It would not be easy for the infantry or the crews of the heavy Vickers machine guns to negotiate this precipitous terrain.⁴⁸ Further back, German reserve divisions threatened powerful counter attacks.

Haig, upon hearing Currie's proposal, warned Currie that the Germans "would not let us have Hill 70."⁴⁹ But as John Swettenham has written, "Currie...planned to turn this German sensitivity towards the loss of Hill 70 to his own advantage."⁵⁰ Once the hill was captured, Currie knew the Germans would launch strong counter attacks to take it back. To defeat them, Currie planned to rush forward 160 heavy machine guns and entrench them on the hill. Each gun would act as a strong point around which other troops could anchor their defence. He also wanted FOOs equipped with wireless, telephones and other signalling

⁴⁷ Martinson, *We Stand On Guard*, 165; Swettenham, *McNaughton*, 98.

⁴⁸ Currie as quoted in Hugh M. Urquhart's *Arthur Currie. The Biography of a Great Canadian* (Toronto: J.M. Dent & Sons (Canada) Limited, 1950), 169; S.F. Wise to author, May 25, 1999.

⁴⁹ Haig as quoted in D.J. Goodspeed, ed., *The Armed Forces of Canada, 1867 - 1967* (Ottawa: Queen's Printer and Controller of Stationary, 1967), 49.

⁵⁰ Swettenham, *To Seize the Victory*, 175.

apparatus, rushed to the summit and entrenched in dug-outs to watch for massing enemy troops and active hostile batteries. From the heights, these FOOs could call down artillery fire on the hapless German forces advancing below to retake the hill. Currie's aim was to use artillery and massed machine gun fire to destroy the attackers.

The assault, launched by the 1st and 2nd Divisions, with support from the 3rd, went in at 4:25 a.m. on August fifteenth. Within twenty minutes the crest was in Canadian hands. By 6:00 a.m. some units had started consolidating the final objective at the base of the hill on the reverse slope. The first German counter attack was launched about nine o'clock that morning. Over the next three days, no less than twenty-one counter attacks were launched by the Germans and crushed by the Canadians. By the time the fighting stopped ten days later, the Canadians had smashed the better part of five German divisions, and inflicted over 20,000 casualties on them. Canadian losses were 9,198.⁵¹ Despite the severity of the fighting, Currie described the battle as "nothing more or less than a slaughter."⁵² He noted in his diary that "our gunners, machine gunners and infantry never had such targets" before.⁵³ The larger objective of preventing German troops from the Lens sector reinforcing the Passchendaele front had succeeded. Hill 70, like Vimy Ridge, remained in Allied hands for the remainder of the war.

The artillery's part in the plan had depended on a careful reading of intelligence. Sound rangers, flash spotters, and ground and aerial observers located forty percent of the estimated 102 German batteries prior to the Canadian assault. The artillery silenced other German batteries on the day of attack as they revealed

⁵¹ Swettenham, *To Seize the Victory*, 178.

⁵² NAC, M.G. 30 E46 (Turner Papers) Vol. 8, Folder 53. Currie to Turner, August 17, 1917.

⁵³ Currie diary for August 18, 1917, as quoted in A.M.J. Hyatt, *General Sir Arthur Currie, A Military Biography* (Toronto: University of Toronto Press, 1987), 77.

their positions to these same observers. The barrage plans had specific guns and howitzers aiming at specific targets. From an analysis of German habits, capabilities, defensive layouts, billeting and reserve areas, likely assembly points, and routes of approach, the Canadians constructed march tables for German reserve troops likely to be employed in counter attacks. These march tables told the Canadians the probable times of arrival of German reserves at selected points within the German defensive zone. The German routes and assembly points were then shelled at appropriate times during the battle.⁵⁴ The 1st Division's after action report stated that this pre-battle study "proved invaluable; all enemy concentrations and counter attacks were dealt with immediately, before they had time to develop."⁵⁵

As at Vimy, the Canadians taped out practice courses on ground similar to that they would cross on Z-Day. The 1st Division's course was made on a four-fifths scale on ground that closely resembled that they were going to storm. Some of the information for building this course came from local inhabitants, but most came from airplane photographs, ground surveillance and patrols.⁵⁶ Every German trench was depicted by tape and flag. 'Name Boards' were put up showing the German names of trenches and positions, while "trench mortar and machine gun emplacements, Battalion, Company, and Signalling Headquarters were all marked on the ground." Miniature models of the area were constructed as well. The 2nd

⁵⁴ NAC, R.G. 9 III C1, Vol. 3850, Folder 61, File 4. Canadian Corps Artillery Order No. 63, August 14, 1917; Swettenham, *McNaughton*, page 100 - 103; John Swettenham, *To Seize the Victory. The Canadian Corps in World War I* (Toronto: The Ryerson Press, 1965), 177.

⁵⁵ NAC, M.G. 30 E15 (Griesbach Papers) Vol. 4. File 23. "1st Canadian Division Report on the Hill 70 & Puits 14 Bis Operations August 15th to 22nd 1917." G.W.L. Nicholson, *Official History of the Canadian Army in the First World War, Canadian Expeditionary Force 1914-1919* (Ottawa: Queen's Printer and Controller of Stationery, 1962), 289-290.

⁵⁶ NAC, R.G. 9 III C3, Vol. 4138, Folder 5, File 11. 6th Brigade to units, July 30, 1917.

Brigade built one such model on a scale of 1:40 at its training school. In addition, an intelligence officer with the 1st Army prepared a plasticine model of the area on a 1: 5,000 scale, and invited the Canadians to study it. From these courses and models the Canadians prepared how best to take the hill, using them to work out solutions to specific tactical problems they would face during the advance. Indeed, attacking troops came to know instinctively where and when to proceed. Consolidation parties also practiced their trade in order to rapidly consolidate newly won positions (a vital component to all attacks considering how fast and hard-hitting German counter attacks tended to be).⁵⁷

The heavy machine guns, more than in any previous engagement, played a prominent part in Currie's plan. Not only did these guns thicken the artillery and trench mortar barrage prior to Zero, they also carried out harassing fire missions. As with the artillery and the infantry, the attacking divisions pre-determined their forward movements to points on Hill 70 in order that they might be available during the consolidation phase, and to fight off the anticipated German counter attacks.⁵⁸

As the 2nd Division noted:

[due] to the limited nature of the operation, it has been possible to allot definite duties to these guns from the outset and they will be employed to take up previously determined positions...

The above guns will be sent forward to take up their positions as soon as possible after the positions have been taken. The positions marked on the Map merely indicate the localities in which the guns are to be placed, the exact position for each gun being settled on the ground.

⁵⁷ NAC, R.G. 9 III C3, Vol. 4105, Folder 19, File 10. 4th Brigade's "Instructions for the Offensive No. 3," July 29, 1917.

⁵⁸ In the 2nd Division there was one machine gun for every thirty-five yards of front during the barrage. Across the Canadian Corps front there were four groups of machine guns each under the control of a senior major or captain; each group consisted of a at least four machine gun batteries, and a machine gun battery was composed of eight guns.

A thorough study of the ground and German assault patterns helped planners select these positions.⁵⁹ General Currie was well pleased with the results. After the battle he wrote: "I have heard nothing but the very highest praise concerning the cooperation by the machine gunners in the attack, and in the repelling of the numerous hostile counter-attacks." He added that "machine gun fire was largely responsible in preventing the enemy from repairing the damage caused by our preliminary bombardment." He asked Brigadier-General Raymond Brutinel, the Corps Machine Gun Officer, to "convey to the machine gunners...my appreciation of the manner in which they performed all tasks allotted [sic] to them."⁶⁰

Aircraft played a prominent role in the accumulation of pre-battle intelligence, and in the defeat of the German counter attacks following the Canadian advance. The 1st Division recorded the "Valuable assistance...rendered to the Division during the preparatory stage of the operations by No. 16 Squadron...[and] Despite the unfavourable weather conditions, [the division was] kept well supplied with absolutely up-to-date photographs of the enemy lines. This was of extreme value, particularly to the Artillery." The No. 16 Squadron also directed artillery fire, spotted and reported on the locations of active hostile batteries, carried out contact patrols, and flew counter attack sorties.⁶¹ Their reports kept commanders well informed on the situation playing out below them. The 1st Division reported how its headquarters was "instantly informed of the situation...[and] instantly informed of any concentrations on the part of the enemy and many splendid targets

⁵⁹ NAC, R.G. 9 III C1, Vol. 3907, Folder 27, File 2. "2nd Canadian Division Instructions for the Offensive No. 2," July 21, 1917; Vol. 3850, Folder 61, File 6. Canadian Corps Scheme of Operations, "Action of Massed Machine Guns," July 26, 1917.

⁶⁰ NAC, R.G. 9 III C1, Vol. 3850, Folder 61, File 6. Currie to Corps Machine Gun Officer, August 30, 1917.

⁶¹ "Counter attack patrols were to identify and locate the massing of German troops for counter attacks, and to [communicate] these targets of opportunity to the artillery. This was a major infantry/artillery support function of the air element." S.F. Wise to author, May 25, 1999.

were thus presented" -- some of which were even engaged by aircraft firing machine guns.⁶² In order to quickly retrieve the information collected by the aerial observers, the 1st and 2nd Divisions, along with the heavy artillery, placed liaison officers at the landing strips. Once on the ground, aerial observers telephoned or personally visited corps headquarters with their news. In this way, noted the RFC's report on the fighting, the "Canadian Corps Heavy Artillery...received detailed information regarding enemy troops, etc., about ten minutes after they had been observed."⁶³

Information reaching battalion headquarters from the front flowed much more slowly. This was so even though ground level communication arrangements were well thought out prior to the advance, and were successful in transmitting a great deal of information. As at Vimy, report centres were widely used by the attacking battalions, and established on conquered ground by scout officers leading specially detailed parties. These kept battalion commanders informed of events at the front. As well, fighting patrols pushed out beyond the final objectives to maintain contact with the enemy, and to secure information on their new positions. At the same time, observers in battalion OPs (constructed prior to the battle) watched the progress of the advance, looked for SOS signals, and watched for Very Lights that indicated objectives had been captured. Using telephones, runners, light signals, and so on, they tried to keep battalion headquarters in touch with events. They also watched for signals sent by the newly established forward centres. Gradually, as the battle progressed, the forward report centres became the

⁶² NAC, R.G. 9 III C1, Vol. 3850, Folder 62, File 1. "Report on Capture of Hill 70 and Puits 14 Bis By 1st Canadian Division, 15th Aug. 1917."

⁶³ NAC, R.G. 9 III C1, Vol. 3850, Folder 61, File 6. Report by 1st Brigade RFC on the action of Nos. 40 and 43 Squadrons on August 15-16, 1917; Vol. 3907, Folder 27, File 7. "Method of Dealing With Active Hostile Batteries on Z Day," No. 16 Squadron, August 1, 1917.

new battalion headquarters.⁶⁴ Heavy enemy shell fire, naturally, did its best to disrupt the flow of information, and regularly cut overland telephone lines and destroyed lamp signal stations. Runners and pigeons found the going tough, too, although they generally got through in time.⁶⁵

Behind battalions information flowed more readily. This was true even for brigade report centres, despite the fact that they were built on newly captured ground during the advance. Brigade signal officers, or the staff captains(I), arranged for the establishment of these report centres -- which were usually set up on ground about mid way between the original front lines and the final objectives. They were usually connected to the rear by buried cable. Thanks to the Herculean efforts of work and signal parties, much of the buried line was extended out into no man's land prior to the assault. It was then just a matter of lengthening the lines on the day of battle. Of course, this was easier said than done when under fire. The usual signalling equipment was on hand at these centres, and included wireless, pigeons, Fullerphones, visual signals, and power buzzers. Runners, and apparatus for contacting airplanes, were also available. Behind the report centres, brigade observers watched the fighting and reported on its progress.⁶⁶ Figure 9.1, "2nd

⁶⁴ NAC, M.G. 30 E236 (Villiers Papers) Vol. 3, Folder 5. 3rd Brigade's "Instructions for the Offensive against Hill 70," July 22, 1917; R.G. 9 III C3, Vol. 4014, Folder 25, File 2. 2nd Brigade's Operation Order No. 212. Also Vol. 4105, Folder 19, File 10. 4th Brigade's "Instructions for the Offensive No. 3," July 29, 1917. Those scouts from battalion intelligence sections that did not go forward to form report centres were available to commanders for special reconnaissance. Machine Gun Companies established their own report centres, and in close proximity to battalion ones.

⁶⁵ NAC, R.G. 9 III C3, Vol. 4014, Folder 26, File 2. 7th Battalion's "Report on Operations -- 15th -- 17th August, 1917." The 2nd Brigade reported that the information carried by pigeons was of little value because of the time it took (about an hour) to retrieve the birds from their lofts located near corps HQ. See its "Report on Operations Carried Out By the 2nd Canadian Infantry Brigade Against Hill 70, August 1917."

⁶⁶ NAC, R.G. 9 III C1, Vol. 3851, Folder 64, File 4. 3rd Brigade's "Instructions for the Offensive against Hill 70 - Lens," July 22, 1917. Also Vol. 4105, Folder 19, File 10. 4th Brigade's "Instructions for the Offensive No. 3," July 29, 1917.

Brigade's Communication Layout at Hill 70,"⁶⁷ illustrates something of the complexity of the flow of information at brigade and battalion levels of command during the attack. Not shown in Figure 9.1 are the contact patrol links and artillery communication arrangements, such as those made for FOOs, and LOs.

The corps, and each divisional headquarters, also built forward report centres, and stocked them with wireless, telephones, visual signals, pigeons,

⁶⁷ Figure 9.1 is based on the diagram shown in the 2nd Brigade's Operation Order No. 212, located at the NAC in R.G. 9 III C3, Vol. 4014, Folder 25, File 2. See also "Report on Operations Carried Out By the 2nd Canadian Infantry Brigade Against Hill 70, August 1917," found in Folder 26, File 2.

The following notes should be read in conjunction with Figure 9.1:

1. Communications available: Telephones, Fullerphones, Visual signalling, Wireless, Power buzzer, Pigeons, Airplane contact patrols, and Runners.
2. Telephones were installed at each battalion HQ, the machine gun company, and the Brigade OP. All were connected to the brigade advanced report centre by buried cables, except the OP, it used laddered lines. Divisional HQ, flanking brigades, artillery, engineers, and so forth, were reached through the brigade rear exchange. Runners were positioned at the various report centres and headquarters. The telephone system worked well throughout the battle, and was the principal method of communication.
3. Fullerphones were installed at each battalion HQ, and at the M.G. company, and were connected to the advanced brigade headquarters (battle headquarters) by buried line.
4. Visual signal stations were located at battalion report centres, the brigade report centre, the brigade battle headquarters and the division.
5. The wireless set at the brigade's battle headquarters was in contact with divisional headquarters. The 2nd Brigade reported that it was not used, except "to send test messages."
6. The IT set (or intelligence telephone) and power buzzer combination was connected to the brigade exchange by telephone, and advanced battalion report centres by power buzzer. (IT sets were used for listening in on German wireless traffic in order to learn German tactical secrets and plans. Routine German orders, such as timings for reliefs, and anything picked up in clear was sent to Corps HQ. Larger interpretations and deciphering were carried out by Intelligence(e) at army HQ. IT sets also monitored friendly telephone conversations for misuse). See, W. Steel, "Wireless Telegraphy in the Canadian Corps in France," *Canadian Defence Quarterly* 7.3 (April 1930), 365 - 375; R.G. 9 III C3, Vol. 4057, Folder 35, File 6.
6. 1st Army memorandum, November 16, 1916, discusses early use of listening sets.
7. Each battalion had six pigeons during the attack under the battalion signal officer.
8. Brigade scouts stationed at brigade OPs were connected to brigade by telephone, visual signals and pigeons.
9. Battalion and company scouts advanced beyond the captured objectives to maintain contact with the Germans and observe their positions.

Figure 9.1: 2nd Brigade's Communication Layout at Hill 70

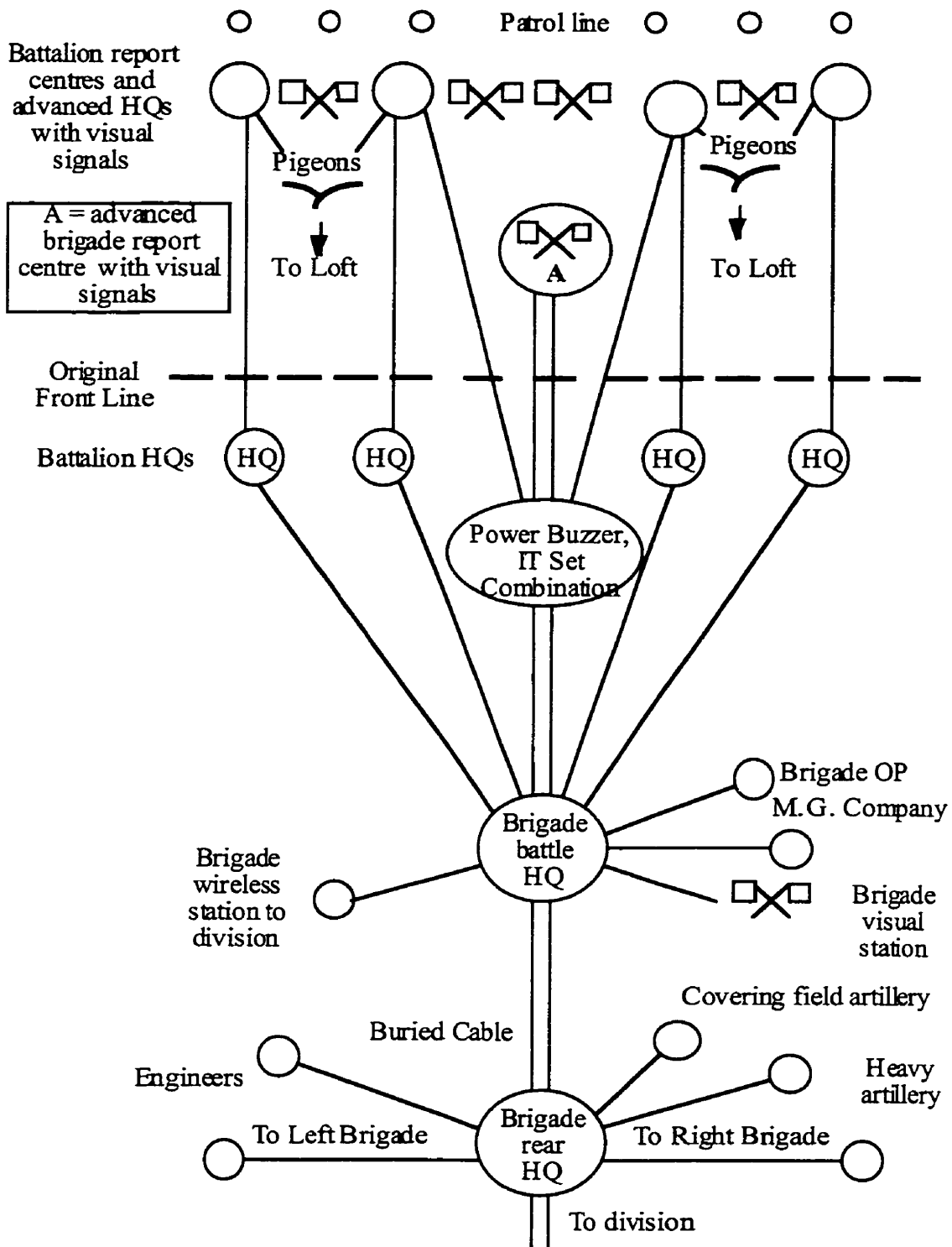

(Everything Above the Dotted Line Was Completed After Advancing)

ground sheets, and despatch riders. In this way they, too, could receive information from all quarters, and remain in touch with the situation unfolding at the front. Most important for controlling the heavy artillery, both before and during the battle, and for rapidly collecting, analyzing, and disseminating artillery intelligence, was the CBO. Its connections to the RFC, FOOs, sound rangers and flash spotters, the infantry, and to all the guns throughout the corps, allowed it to supervise the actions of the guns, and to build up a picture of the German artillery dispositions. This information kept corps headquarters in touch with the enemy's artillery movements both before and during the action.

As already mentioned, FOOs played a pivotal role at Hill 70. Each divisional artillery brigade sent forward an FOO with a team of signallers into the newly captured terrain. Relay stations for sending information from these forward posts were arranged by the FOOs as they advanced. Most FOOs reached their destination in good order, having practiced getting there before the battle. Heavy shell fire, however, "rendered it impossible to keep up telephone lines and information had to be sent back by runners or visual." Despite the loss of the telephone link, the 1st Division's after action report could still boast that from "Zero onwards...constant reports were received from L.O's and F.O.O's indicating the successful advance of our Infantry" and the barrage. By 6:30 a.m., some two hours after zero, "Most valuable reports commenced to come in" from the FOOs. "Reports on movement, enemy infantry concentrations, active batteries etc. were sent back quickly and accurately throughout the day," as were sightings of SOS signals and Very Lights marking the capture of objectives. With this information in hand, and used in combination with the reports of other air and ground observers,

the artillery learned about valuable targets to shell.⁶⁸

Heavy artillery FOOs also went forward. According to McNaughton, it was their job to “take full advantage of the observation which will be obtained [from the capture of the hill] to bring fire to bear on active Hostile Batteries and other Targets of Opportunity, which present themselves and to collect and forward information concerning the tactical situation.”⁶⁹ These FOOs worked in pairs; one stayed at the fixed OP established on Hill 70 after its capture, the other moved forward to keep in touch with the infantry. The forward FOO then sent reports back to his partner for transmission to the rear. Runners accompanied both FOOs. Signallers worked with the FOOs at the fixed posts, manning the telephones and operating the wireless sets that accompanied them. The use of wireless helped restore immediacy to the battlefield, as FOOs could immediately relay news to the gunners concerning German infantry movements and hostile batteries sighted. This was the first time the Canadians used wireless this way, and it proved “very useful as confirmation of other reports and also in determining the strength of counter attacks.”⁷⁰ On the whole, observation was so good during the battle that the artillery could not answer all the calls made by FOOs.⁷¹ This was good news for

⁶⁸ NAC, R.G. 9 III C1, Vol. 3850, Folder 62, File 1. “Report on Capture of Hill 70 and Puits 14 Bis By 1st Canadian Division, 15th Aug. 1917;” R.G. III C3, Vol. 4014, Folder 27, File 4. Artillery “Instructions Re Forward Communications,” July 24, 1917.

⁶⁹ NAC, R.G. 9 III C1, Vol. 3907, Folder 27, File 7. “Forward Observation,” Lt. Col. McNaughton, July 23, 1917.

⁷⁰ NAC, M.G. 30 E15 (Griesbach Papers) Vol. 4, File 22. “1st Canadian Division Report on the Hill 70 & Puits 14 Bis Operations August 15th to 22nd 1917;” R.G. 9 III C1, Vol. 3907, Folder 27, File 8. Artillery Order No. 52, “Artillery Plan for the Capture of Hill 70;” R.G. 9 III C1, Vol. 3907, Folder 27, File 7. Counter battery Officer Order No. 39.

⁷¹ NAC, M.G. 30 E46 (Turner Papers) Vol. 8, Folder 53. Currie to Turner, August 17, 1917. Each artillery brigade sent forward an FOO, see R.G. 9 III C3, Vol. 4014, Folder 27, File 4. “Instructions Regarding Forward Communications,” July 24, 1917, 1st Divisional Artillery.

the Germans, for as it was they were slaughtered.

Liaison officers, meanwhile, helped keep the different combat arms in touch with each other. In the case of the heavy artillery, their LOs were at each of the attacking infantry brigade headquarters, both before and during the battle. There they were responsible for keeping in touch with the success of bombardments and wire cutting programs, and for passing counter battery information along to the heavy artillery headquarters. They also kept track of enemy shelling by collecting news on the size of projectiles fired, the area shelled, the timing and intensity of the shelling, the direction from which the shells came, and the time the shelling stopped. Furthermore, they had to be fully aware of the infantry's situation in order to provide up to date information to the gunners. In this way they assisted the infantry in the selection of targets. Close cooperation with the field artillery was required, too, which meant LOs were not to be shy about using the field artillery's OPs if they provided the best view of the front. In addition, the heavy artillery LOs made frequent visits to battalion headquarters, where they explained the heavy artillery situation, and encouraged mutual cooperation and understanding.⁷² Meanwhile, the field artillery kept its own LOs at the various infantry brigade headquarters. It also placed recording officers with each assaulting battalion. During the attack these officers remained at the report centre of the battalion they were working with where they gathered information from the infantry and sent it to their artillery group headquarters. The 1st Division reported that liaison "was most satisfactory in every way, and the closest possible touch was maintained between the Artillery and the Infantry it covered...Both Brigade and Battalion L.O's were in practically continual communication and sent back most valuable information."⁷³

⁷² NAC, R.G. 9 III C1, Vol. 3907, Folder 27, File 2. "Liaison Officers," Canadian Corps Heavy Artillery, July 17, 1917.

⁷³ NAC, R.G. 9 III C1, Vol. 3850, Folder 62, File 1. "Report on Capture of Hill 70 and Puits 14 Bis By 1st Canadian Division, 15th Aug. 1917;" Vol. 3907, Folder 27, File 2. "2nd Canadian Division Instructions for the Offensive No. 2,"

Each attacking infantry brigade and battalion also exchanged liaison officers, while liaison between the infantry and the machine gun groups was also arranged.⁷⁴ After the battle, General Currie wrote that “liaison seemed to have been very good indeed.” He added, “Success such as we have had is only possible when each branch of the Service pulls it’s [sic] own weight, and all pull together.”⁷⁵ Liaison officers had helped foster corps cohesion and information exchange, and in the process helped with command and control.

Pre-battle and battlefield intelligence had once again played an important role in the corps’ success. Most of the 1st Division’s list of sixteen lessons learned from the battle, for example, made this very clear. While intelligence work is not the main topic of each lesson, its underlying significance is readily apparent. The first lesson, for instance, praised “the plan being thoroughly worked out in every detail and of it being understood by all who took part.” This let every officer and man know their “own particular duty, however small.” Lesson two pointed out the importance of “Careful training over the taped courses,” while lesson three applauded the “Great value of a replica of the ground, constructed on a large scale, 1 to 40, showing the HILL features, woods and buildings.” The importance of secure communications and “Perfect liaison between the Infantry and the Heavy and Divisional Artillery” was commented on in lesson six and seven. Likewise, close liaison between the infantry and the machine gun organization was valued, and referred to in lesson eight. “The importance of good O.Ps. for Infantry and Artillery” was the subject of lesson nine. The work of observers meant that

July 21, 1917; 2nd Divisional Artillery notes on liaison, July 23, 1917; and R.G. 9 III C3, Vol. 4105, Folder 19, File 10. 4th Brigade’s “Instructions for the Offensive No. 3,” July 29, 1917.

⁷⁴ NAC, R.G. 9 III C1, Vol. 3907, Folder 27, File 2. “2nd Canadian Division Instructions for the Offensive No. 2, Appendix A,” July 25, 1917; Vol. 3850, Folder 61, File 6. Canadian Corps Scheme of Operations, “Action of Massed Machine Guns,” July 26, 1917.

⁷⁵ NAC, R.G. 9 III C1, Vol. 3850, Folder 61, File 6. Currie to Corps Machine Gun Officer, August 30, 1917.

information could be confirmed and the necessary action taken “without hesitation or doubt as to the situation.” Lesson ten pointed out the importance of having a scheme of destructive and harassing fire in place previous to an operation. In this way, “every portion of the area to be attacked [could be] subjected to fire from either Heavy or Divisional Artillery, or Machine Guns at every hour of the day and night.” Finally, lesson eleven speaks to the need for detailed artillery plans for dealing with enemy counter attacks. At Hill 70 such advanced planning “proved invaluable; all enemy concentrations and counter attacks were dealt with immediately, before they had time to develop.” In short, what the 1st Division was saying in these lessons was that the wise use and study of intelligence helped the Canadians win and hold Hill 70.⁷⁶

Indeed, so important was intelligence work, and so entwined was it with communications, that after the Hill 70 operation ended, intelligence staff officers gradually assumed greater control over signal arrangements throughout the corps. At a conference of divisional and artillery intelligence officers held in September, it was pointed out that “In some Divisions the [General Staff] Officer (Intelligence) has been responsible for the arrangements of all communications [within the division] with technical advice from the Signal Officers and this system has worked out well.”⁷⁷ By the end of 1917 and into 1918, the Canadian Corps was saying that it was one of the duties of the senior divisional intelligence officer “To ensure that the best possible use is made of the Signal Service in connection with all schemes both of Defence and Offense and to co-ordinate the communication of all units in the forward divisional area. The O.C. Signal Company would be the

⁷⁶ Ibid.

⁷⁷ NAC, R.G. 9 III C3, Vol. 4024, Folder 3, File 2. “Conference of Divisional And Artillery Intelligence Officers. Held at Canadian Corps H.Q. 22 - 9 - 17.”

technical adviser in this work.”⁷⁸ This spreading of their influence over signals truly announced the arrival of intelligence officers and personnel, proving they were of the utmost importance to Canadian Corps planning and operations.

Moreover, by acting as information filters, and controllers of news from the front, intelligence personnel made their influence felt on the field in ways unimaginable in 1915. As Henry Eccles, a onetime rear admiral in the United States Navy, wrote: “The person who determines the flow of information to the commander will to a significant degree dominate the commander’s decision.”⁷⁹ This is not to say that intelligence officers usurped command authority, but is meant to point out that through their control of report centres and observation posts, they decided what information was urgent, and determined what information to forward to headquarters, and in what priority. This was a heavy responsibility, and one that was evolving since at least as early as the summer of 1916, when the 1st Division declared that “After August the 30th any messages which are handed in to a Signal Station, Relay Post, or Runners’ Post by a man of Brigade or Battalion Intelligence Sections, (all of whom wear the Scout’s badge), will be accepted for transmission as if the message had been signed by an officer.”⁸⁰ Being well positioned at the front, intelligence officers and men were often better informed of the situation than battalion and other commanders further back. An American observer visiting the Canadian Corps in December 1917, noticed this same power shift and ability of intelligence officers to shape battles. He stated to his superiors that

⁷⁸ NAC, R.G. 9 III C3, Vol. 4224, Folder 6, File 13. Canadian Corps to 4th Division, December 26, 1917; M.G. 30 E100 (Currie Papers) Vol. 37, File 165. “Intelligence Organization 4th Canadian Division,” January 22, 1918; R.G. 24, Vol. 22,011. “Intelligence Instructions. Canadian Corps,” issued in July 1918.

⁷⁹ Henry E. Eccles, *Military Concepts and Philosophy* (New Brunswick, NJ: Rutgers University Press, 1965), 198.

⁸⁰ NAC, R.G. 9 III C3, Vol. 4025, Folder 7, File 4. 1st Canadian Division to subordinate commands, August 26, 1916.

Experience in the Canadian Corps has convinced the officers of the line as well as the staff of the great importance of intelligence, in fact, the operations of the troops after the fight starts is largely directed by the intelligence officer. It is felt that he is the man who knows the condition of the enemy and the obstacles which the troops will have to meet, and it is, therefore, for him to decide how the attack should be conducted. The officer in charge of operations is principally concerned with the getting up of the troops, the reliefs of divisions that have been exhausted and of other matters pertaining to the personnel of the fighting units, while the objects and objectives to be accomplished are covered by the intelligence officer. This is a rather new phase of intelligence, but it seems to me to be the logical conclusion to reach for it would seem a great waste of energy for the intelligence officer to obtain all the information and be responsible for the information and then when the information is to be used to have nothing to say about how, when, or where the troops use it. In the Canadian Corps the intelligence officer is the directing officer and is in close liaison with the operation officer, in fact, the operation officer and the intelligence officer have desks at the Corps Headquarters opposite each other.⁸¹

The intelligence officers' role had come a long way from Salisbury Plain, where it was ill-defined, or non-existent.

At Vimy and Hill 70 the Canadians implemented a winning formula for defeating entrenched positions. As a number of officers stated, the first factor of success was amassing intelligence on the enemy's defences, and the intervening terrain. Here, front line gatherers such as battalion and brigade observers, sound rangers, and the RFC were vital. The information they collected formed the basis of the incredibly complex plans necessary for assaulting and holding a fortified

⁸¹ LTC Arthur L Conger Papers, U.S. Military History Institute, Carlisle Barracks. "Headquarters American Expeditionary Forces, Office of the Chief of Staff, Intelligence Section," January 1, 1918. My thanks to Dr. J. Ferris for sharing this document with me. J.E. Hahn, in *The Intelligence Service Within the Canadian Corps 1914-1918* (Toronto: The Macmillan Company of Canada, 1930), 98 - 99, also alludes to the ability of intelligence officers to direct the action. Speaking specifically of staff captains(I), Hahn states that they "should be in close touch with the affiliated arms covering the attack, and be in a position to switch a concentration against any portion of the enemy line should any unexpected resistance be encountered, or an assembly detected either during or after the assault...A battery of heavy machine guns...should be sited in close proximity to the O.P. [where the staff captains(I) are situated], as they can be quickly directed on any targets or concentrations within range."

position. Not only did intelligence point out the locations of enemy positions, but was used by the Canadians when building the practice courses over which the men rehearsed their particular role in the battle. Specific tactical features and dilemmas were then studied on the ground, and solutions worked out in advance in the peace and quiet of normal trench warfare. By practicing over taped courses, men came to know their task, and this eliminated a great deal of battle friction on the day of advance. It also meant that should communications fail, the assault would not come to a grinding halt, as commanders could trust their men to carry on as rehearsed with minimal guidance from above. Meantime, ground level communications and the RFC struggled to inform rear area commanders of front line conditions. The RFC was particularly successful in doing this, increasing the artillery's flexibility enormously in the process. This was no small affair given the importance of the big guns to winning trench warfare. None of this is to argue that there were not other factors contributing to the corps' battlefield success. Tactical skill, bravery, the state of enemy morale, and so forth, all played crucial roles. Indeed, the tactical acumen of the men meant that they could continue pressing forward in the face of great odds, and without immediate support from gunners and others. But neither can the role of intelligence be ignored – it certainly was not by the officers and men of the day, and with each passing Canadian Corps success, the intelligence organization grew in size and stature.

CHAPTER TEN
PASSCHENDAELE: OCTOBER - NOVEMBER 1917

Following its stellar performance at Hill 70, the Canadian Corps was in fine fettle, and able to collect the finest minutiae on German positions necessary for preparing the detailed and highly intricate plans required for winning set-piece, limited objective assaults. The rigidity of those plans was tempered by flexible tactics and a communications system that, although far from perfect, was of sufficient utility that a continuous stream of information flowed from the sharp edge to rear area decision-makers. At Passchendaele, in late October and early November, this approach to battle went up against a new-style, elastic defence, built in depth, that did away with discernible trench systems. With this defence the Germans held their forward-most outpost line lightly, relying on machine guns arrayed in a checkerboard fashion to form interlocking, mutually supporting, killing zones. The highly motivated machine gun crews that manned these guns were sheltered from Allied bombardments by heavily camouflaged pillboxes built strong enough to withstand direct hits from all but the most powerful guns. As Allied bombardments passed over these positions, the crews inside reemerged to man their guns in order to start cutting down the advancing troops struggling towards them through the bog that covered no man's land. It was the machine gunners' task to break-up attacks before they reached the German main line of resistance, also strongly fortified, and lying further to the rear. German artillery covered these forward zones, and were poised to destroy any and all attacking infantry. Counter

attack divisions, capable of launching hard hitting counter attacks against any Allied gains, were positioned several miles behind these defences and out of artillery range, ready to assault should the need arise. It was a formidable defence, one made even more impregnable by the deep and sticky mud that covered much of the Passchendaele battlefield, the poor weather, the need for the Canadians to attack up hill, and the near domination of the skies by German pilots.

Although the Canadians had served in the Ypres Salient before, during the Second Battle of Ypres and at the St. Eloi Craters, the terrain was, by October 1917, wholly unrecognizable. Three years of heavy shelling had turned the landscape into “a desolate wilderness of scummy water-filled craters, ragged tree stumps and deep glutinous mud.” Any roads that had existed before the war were long removed, while the incessant shelling smashed open the water-table, causing widespread flooding of the lower lying ground and shell holes (which also happened to be the ground the Canadians occupied or had to cross over). It was, on the whole, an engineering and human nightmare, as the knee-deep mud rendered even the simple movement of guns, equipment and men a colossal task. The terrain also made the collection of intelligence far more difficult as scouts could not freely move about no man’s land, while the obliterated landscape made ground and aerial observation difficult. Interpreting aerial photographs was extremely laborious as German strong points could be located in any one of the thousands of shell holes that covered the front. Physical and mental exhaustion was the normal state of affairs. Add to this the stench of rotting corpses and the debris of three years of war, and it is easy to understand why many regard the Passchendaele battlefield as

the worst place the Canadians ever found themselves during the entire war.¹

The Canadian goal was to secure the village of Passchendaele and the ridge on which it sat, both lying some 1,500 to 2,000 yards distant. Rather than try to cut through the entire German defensive system by going all out for the ridge in one grand attack, Currie opted for a series of bite and hold set-piece assaults. It was his intention to advance the Canadian line in 500 yard increments, and thereby avoid taking on the full strength of the enemy's defence at one time. Such a plan invited strong German counter attacks and heavy retaliatory shelling, since much of the German defensive system would remain intact. Rapid consolidation of positions, close cooperation between supporting arms, and an effective counter battery program were, thus, essential to success. The set-piece assault seemed made to order for Currie's plan, as the Canadians excelled at bite and hold tactics. Set-piece attacks, as we have seen in previous chapters, let commanders retain some control over the fighting by pre-arranging movements; and at Passchendaele this was important, for the battlefield and the German defences evoked confusion. The 2nd Army commented on this as early as August 1917 in its "Notes on Training and Preparation for Offensive Operations" when it said:

The new system of defence adopted by the enemy, consisting of lines of shell holes in depth and a large proportion of his strength disposed in readiness for counter-attacks, is liable to produce a condition of affairs by which --

(a) The further we penetrate his line, the stronger and more organised we find him.

(b) The further we penetrate his line, the weaker and more disorganized we are liable to become.²

¹ John Marteinson et al, *We Stand On Guard. An Illustrated History of the Canadian Army* (Montreal: Ovale Publications, 1992), 169.

² National Archives of Canada (NAC), Record Group (R.G.) 9 III C3, Vol. 4025, Folder 7, File 5. 2nd Army's "Notes on Training and Preparation for Offensive Operations," August 31, 1917.

A deep penetration, in other words, risked the loss of control, as it meant extending the already temperamental communications systems past their endurance. It also required a rapid forward movement of guns and other forms of support for the advancing troops as they pushed ever deeper into the German lines. As this demanded far greater coordination than the Canadians were used to, and over a field of battle not given to mobility, Currie was wise to stick to the limited set-piece assaults the corps had perfected.³

Intelligence work was vital to the success of Currie's plan, for set-piece assaults depended on an ample supply of accurate and timely information. Therefore, "As soon as the Corps received warning that they were to move to the Second Army to take part in the offensive operations," stated a post battle report by the Canadian Corps, "an Intelligence Corps Officer from Corps Headquarters was sent to Second Army H.Q. to be attached to them and to get in touch with the situation."⁴ General Currie's report supplies further detail. In it he wrote:

From the moment when definite orders were received as to which Sector the Canadian Corps was to occupy a representative of the Corps Intelligence Staff went to live at the Headquarters of the II. Anzac Corps [whom the Canadians were replacing] and started to study and compile records of the enemy's defences and dispositions for issue to the Divisions. This was on 12th October, i.e. 10 days before our first divisions went into the Line. Similar arrangements were made by divisions, so that on 17th October, i.e. 5 days before our divisions went into the Line and 9 days before our first attack, complete, detailed maps and logs were issued to units, giving them in convenient form everything that was known as to what they had in front of them.⁵

³ Robin Prior and Trevor Wilson, *Passchendaele: The Untold Story* (New Haven: Yale University Press, 1996), 173.

⁴ NAC, Manuscript Group (M.G.) 30 E 100 (Currie Papers) Vol. 36, Folder 164. Canadian Corps to 2nd Army, November 16, 1917.

⁵ NAC, R.G. 9 III C1, Vol. 3854, Folder 71, File 7. Currie to 2nd Army, November 20, 1917.

The 3rd Division report on Passchendaele describes in greater detail the divisional intelligence effort leading up to the first and subsequent assaults. On October thirteenth and fourteenth, divisional staff held meetings with brigade and battalion officers to discuss the situation at the front. Over the next two days divisional headquarters gathered corps and divisional Intelligence Summaries from outgoing commands, and made notes on the fighting from talks with officers in formations recently removed from the fighting. From this data divisional intelligence officers prepared a divisional log and file,⁶ which they issued to subordinate commands on the seventeenth and eighteenth of the month. The object of this file and log was to insure that “all unit commanders from the Divisional Commander to company and battery commanders were in possession of complete and uniform information...regarding the enemy,” and to ensure that all commands were “working from similar maps and information.” Each ground observer also received copies, thus allowing them “to start their study and reconnaissance of their unit’s objective with complete information as known of the enemy defences in their respective area.” On the eighteenth an advanced divisional intelligence headquarters opened at the New Zealand divisional headquarters, and four days later, October twenty-second, the 3rd Division assumed control of the line.⁷

⁶ The divisional Intelligence File, introduced by the 3rd Division in the summer of 1917, was another valuable medium for storing and transferring information. The file contained all the intelligence relating to the divisional front, and was handed over to incoming divisions upon relief, thus smoothing reliefs. Currie stated that the divisional Intelligence File allowed for “A system of disseminating information to all concerned by a more intelligible and comprehensive method” than had been the case earlier, and proved useful in coordinating the efforts of the various combat arms within divisions. See A.W. Currie, “Historical Resume of Canadian Corps Intelligence,” in J.E. Hahn, *The Intelligence Service Within the Canadian Corps, 1914-1918* (Toronto: Macmillan Company of Canada, Limited, 1930), page xx.

⁷ NAC, R.G. 9 III C1, Vol. 3853, Folder 68, File 7. “Intelligence, 3rd Canadian Division, For Bellevue Spur Operations of 26th and 30th October, 1917;” see also M.G. 30 E 100 (Currie Papers) Vol. 36, Folder 164. Canadian Corps to 2nd Army, November 16, 1917, and Hahn, *The Intelligence Service*, 213 - 223.

In the meantime, and days in advance of their entry into the lines, brigades and battalions began accumulating their own information. In the 3rd Division, brigade staff captains(I) held a conference on the night of October sixteenth (six days prior to the division assuming control of the line) to discuss the situation. The next day "One officer and six observers from each battalion of the two attacking brigades, and staff-captains 'I' with six brigade observers went forward to WIELTJE" (a town near the front lines) and established advanced headquarters units. On the nineteenth, that is three days before the 3rd Division assumed command of the line, Canadian "Brigade and battalion advanced parties reconnoitred the forward area and established brigade and battalion O.P's."⁸ Then, once battalions were in position, a steady stream of officers went forward to reconnoitre the ground.⁹

All this pre-planning, intelligence accumulation, and study meant that the Canadian relief of the Anzacs proceeded without a hitch. The Canadian Corps reported to the 2nd Army that:

The salient features of this relief are that Corps and Divisions were so thoroughly in touch with the situation that, on the day on which they became responsible for the line, the actual handing over was merely a matter of form and, what is still more important, all units entering the area had been supplied with all available information several days before they went into the area and their own observers were already working there.¹⁰

Training, too, benefited from the massing and study of intelligence. The 1st Battalion recorded:

⁸ NAC, R.G. 9 III C1, Vol. 3853, Folder 68, File 7. "Intelligence, 3rd Canadian Division, For Bellevue Spur Operations of 26th and 30th October, 1917;" see also M.G. 30 E 100 (Currie Papers) Vol. 36, Folder 164. Canadian Corps to 2nd Army, November 16, 1917.

⁹ NAC, R.G. 9 III C1, Vol. 3859, Folder 85, File 8. 1st Brigade to 1st Division, November 20, 1917.

¹⁰ NAC, M.G. 30 E100 (Currie Papers) Vol. 36, File 164. Canadian Corps to 2nd Army, November 16, 1917.

For some time prior to the attack special training was carried out along lines suggested by the experiences of other Divisions on the YPRES front. Every scrap of information as to the nature of the country and the enemy's methods was studied and schemes laid out and practiced involving the tactics necessary to defeat the enemy...

Datta supplied prior to the attack proved of the greatest value especially in training.¹¹

The 1st Division remarked on the "great value" of the model, scale 1/400, built at corps headquarters, and noted how all of the attacking officers reviewed it before the November sixth attack, along with forty percent of the NCOs in the 1st Brigade, and seventy-five percent of the NCOs in the 2nd Brigade.¹² Units rehearsed their parts in the assault over taped courses in order to teach the men the necessary methods for defeating enemy pillboxes and other defences, and to familiarize them with the particulars of the front they had to cross and capture. Before the November sixth assault, a full dress rehearsal was carried out. The supporting arms (machine guns, artillery, and trench mortars) rehearsed alongside the infantry to breed familiarity. This also taught them where and when to proceed on the day of battle.¹³

Assault and consolidation plans used the latest intelligence.¹⁴ Indeed, the commander of the 1st Brigade, Brigadier-General William Griesbach, wrote: "The first factor of success [was] early information as to the task to be performed, the boundaries, the objectives, the terrain and all possible information upon the subject

¹¹ NAC, R.G. 9 III C3, Vol. 4033, Folder 3, File 3. 1st Battalion to 1st Brigade, November 13, 1917.

¹² NAC, M.G. 30 E60 (Matthews Papers) Vol. 3. "1st Canadian Division Report on the Passchendaele Ridge Operation November 4 - 12, 1917."

¹³ Prior and Wilson, *Passchendaele*, 175; Bill Rawling, *Surviving Trench Warfare, Technology and the Canadian Corps, 1914-1918* (Toronto: University of Toronto Press, 1992), 151, 160.

¹⁴ NAC, R.G. 9 III C1, Vol. 3853, Folder 68, File 4. "2nd Canadian Division Instructions for the Capture of Passchendaele," November 2, 1917.

secured from maps, photographs and general intelligence.” He further believed that all these details “should be handed down to the lowest formations and diligently and earnestly studied so that all the facts are committed to memory down to platoon commanders and a map of the ground is stamped upon the minds of all officers.” The officers in his brigade, to ensure that they were aware of the most recent developments at the front, followed the “fluctuations in the fighting” “from day to day and hour to hour.” Any relevant observations were then incorporated into the plan. For example, when the brigade “learned that the enemy brought his barrage down either on or immediately in rear of our line, it was agreed that our forming up for the attack should be as close to the enemy as possible.” Further,

When it was learned that whole companies had been shot down and lay dead practically in the line on which they stood while advancing under the barrage, it was agreed that this Brigade would advance to the attack in section columns behind the barrage dashing from cover to cover, which was done and was successful. When it was learned that the enemy took cover in his pill boxes but fought from trenches in the neighborhood of the pill box, it was agreed that the attack must be made at high speed and with great determination to catch the enemy before he emerged from his pill box or as soon thereafter as possible and this was carried out and it was successful.

So important was intelligence to planning that final “orders for the attack were not issued until all available information was in hand,” and not until the brigade commander had consulted his battalion commanders “as to the best method of launching the attack.”¹⁵ Photographs were valuable here, for they showed the locations of impenetrable terrain caused by excess mud and water. Infantry plans

¹⁵ NAC, R.G. 9 III C1, Vol. 3859, Folder 85, File 8. 1st Brigade to 1st Division, November 20, 1917; Rawling, *Surviving Trench Warfare*, 160, cites a similar study by another brigade, which also led to alterations in procedures. In the 6th Brigade, “After two days of observing enemy shelling...scouts determined that the best time to move was just before dawn, before the Germans fired their early-morning bombardment, and by moving troops at that time, battalions suffered only slight harassment.”

had the men skirt these areas, as plans took the terrain fully into account.¹⁶ The corps commander agreed that pre-battle study was crucial. "Before committing our Infantry to the assault of a position," wrote Currie, "we must be quite sure that every detail of the enemy's defences, especially wire, is known and adequately dealt with."¹⁷

Artillery plans, too, relied on information regarding the enemy's position and movements. Consequently, intelligence staff collected information on hostile battery locations, wire entanglements, trench junctions, OPs, telephone lines and exchanges, and so forth. Ground observers opened a series of artillery OPs prior to the Canadians' first advance. From these points FOOs and others monitored Allied shelling. On October twenty-first, the infantry and the artillery opened combined infantry -- artillery OPs for mutual benefit and liaison purposes. From these OPs, infantry observers and FOOs submitted joint reports on the daily progress of destructive shoots, wire cutting, and other observations made.¹⁸ Currie commented favourably on the value of these joint posts, and on the contribution such close liaison made to the victory, pointing out that close touch between the infantry and the artillery "is vital to the success of any operation."¹⁹ The accuracy and usefulness of destructive shoots, of preliminary bombardments, of harassing fire programs, of counter battery fire, and of the creeping barrage all depended to some degree on information collected by artillery and infantry ground observers. Information derived from prisoner interrogations, captured documents, aerial observation and photography supplemented their work, providing the artillery with

¹⁶ NAC, M.G. 30 E15 (Griesbach Papers) Vol. 5, File 29. "1st Division Report on Passchendaele Ridge Operations November 4 - 12, 1917."

¹⁷ NAC, R.G. 9 III C1, Vol. 3854, Folder 71, File 7. Canadian Corps to 2nd Army, November 20, 1917.

¹⁸ NAC, R.G. 9 III C1, Vol. 3853, Folder 68, File 7. "Intelligence, 3rd Canadian Division, For Bellevue Spur Operations of 26th and 30th October, 1917."

¹⁹ NAC, R.G. 9 III C1, Vol. 3854, Folder 71, File 7. Canadian Corps to 2nd Army, November 20, 1917.

an enormous amount of high quality intelligence.

The accumulated intelligence allowed for the preparation of detailed artillery plans. As usual these encompassed systematic wire cutting, and the destruction of all known German strong points and pillboxes. An extensive harassing fire program “on enemy approaches and back areas” was also carried out. Several ‘false-start’ barrages were employed before each attack to train the Germans to take cover and stay under cover out of fear that the barrage would return. In other words, “The frequency of the barrages and their extent throughout the Army front left the enemy in doubt as to the reality of the attack, and its extent.” The CBO prepared a vigorous counter battery program and, as usual, it embraced more than just the elimination of hostile batteries. The heavy artillery harassed the German defenders prior to the assault, fired gas bombardments, shelled attacking German counter attack forces, and helped reduce enemy fire at critical periods throughout the Passchendaele operation.²⁰

Similarly, planners worked out the actions of the heavy machine gun batteries before their advance. Heavy machine guns helped thicken the creeping barrage and neutralize hostile machine guns, and gave protective covering fire to the infantry consolidating their final objectives. The guns themselves were not haphazardly deployed. Guns had specific sections of front to cover, which they did for specific periods of time. They also took on any opportunity targets that presented themselves.²¹

²⁰ NAC, R.G. 9 III C1, Vol. 3908, Folder 2, File 29. Canadian Corps Heavy Artillery Operation Order No. 90, October 23, 1917; R.G. 24, Vol. 1832, Folder: GAQ 8-15d. “Canadian Corps Artillery Report on Passchendaele Operations Oct. 17th to Nov. 18th 1917.”

²¹ NAC, R.G. 9 III C1, Vol. 3852, Folder 65, File 10. “Action of Massed Machine Guns,” part of Operation Order No. 165, November 4, 1917; Folder 65, File 11, “Action of Massed Machine Guns,” part of Operation Order No. 159, October 23, 1917. Also see Vol. 3853, Folder 68, File 3. “1st Canadian Division Report on the Passchendaele Ridge Operations, 4th to 12th November, 1917;” and File 4. “2nd Canadian Division Instructions for the Capture of Passchendaele,” November 2, 1917.

Once plans were in motion the collection and dissemination of intelligence continued; indeed, it was crucial that it did. This was because less was known with certainty of the German positions at Passchendaele than was the case in other Canadian battles in 1917. Given the terrain, the depth of the defence, the poor weather, the German command of the air, and their increased use of camouflage, it was not possible to discover all the secrets of the German line beforehand to the same degree as at, say, Vimy Ridge or Hill 70. Although planning -- especially artillery programs -- remained a highly complex undertaking, the less than complete intelligence at Passchendaele meant that the time-table tactics of earlier battles had to be tempered with an even greater degree of command flexibility and initiative at the junior officer level and in the ranks than had previously occurred. It was certainly true that pre-planning continued to mold the general direction of battle, but now the Canadians had to make more real-time decisions while the action raged; the appearance of previously unknown obstacles and predicaments demanded immediate resolution.²² The Canadians were not surprised by this turn of events, as Canadian tactical training had long emphasized small unit initiative, infiltration, and the principles of fire and movement for dealing with just such circumstances. These tactics, in other words, helped keep advances rolling, even when the assaulting forces faced unforeseen problems unaccounted for in the larger plan. The call for such small unit initiative can be seen in the 9th Brigade's orders of October 22, 1917.

Should any part of the line be held up by machine guns, wire or other unforeseen [sic] circumstances, units on the flank must push on through the gap and endeavour to envelop the obstacle. In the case

²² These real-time decisions were not of the same variety as those made by FOOs at Hill 70, when FOOs called down artillery fire on massing enemy troops and hostile batteries. At Hill 70, the plan called for FOOs to be in specific positions to watch for such movements; at Passchendaele many German positions and responses were unknown elements when the troops went over the top, and so specific Canadian actions against them could not be so carefully pre-arranged.

of wire, units who cannot get through themselves should endeavour to assist neighbouring units by using covering fire of rifles etc. to keep the enemy's heads down whilst reserves are pushed through the gaps.²³

Increased uncertainty, moreover, called for greater coordination between the infantry and its supporting arms than hitherto, and it was in helping commanders do this that intelligence work played a valued role. Without knowledge of the infantry's position, commanders of supporting units could not effectively intervene in the fighting to take advantage of opportunities as they arose. Meanwhile, infantry commanders needed timely information themselves if they were to continue shaping the fight through their use of reserves and by other interventions. Currie referred to this cooperation in a post action report when he wrote:

The timely and correct use of reserves in fighting of this nature [as at Passchendaele] is of immense importance. In dealing with the pillbox system of defence, which are organized in great depth and difficult to locate accurately beforehand, there are almost sure to be gaps in the advance and only the prompt use of reserves can remedy the situation.²⁴

Although Currie does not explicitly mention intelligence in this quotation, it seems clear that the "prompt use of reserves" is impossible without a commander learning of the conditions at the front as it unfolded.

Helping to secure the necessary information were battalion, brigade, and corps-level observers manning the observation posts dotting the front. From these posts, observers watched for signals and monitored the progress of the advance on behalf of their respective commanders. The corps concluded that "in all operations it has been found that these observers are most useful." Divisional observers,

²³ NAC, R.G. 9 III C1, Vol. 3853, Folder 68, File 3. "1st Canadian Division report on the Passchendaele Ridge Operations, 4th to 12th November, 1917."

²⁴ NAC, R.G. 9 III C1, Vol. 3854, Folder 71, File 7. Canadian Corps to 2nd Army, November 20, 1917.

however, were not required at Passchendaele “as all local and detailed information is supplied by Battalion and Brigade Observers while all general information is obtained by Corps Observers.”²⁵ Brigade OPs, in fact, “were maintained in positions from which they could observe at least the final phase of the attack and the final objectives. These O.Ps. were in telephonic communication with their Brigade H.Q. and whenever communication was possible their reports were found to be of very great use.” After its assaults on October thirtieth, the 7th Brigade announced: “The work of the Brigade Observers left little to be desired; shelled from one O.P. to another they still kept up their stations...and regularly transmitted their views to Headquarters.”²⁶ The value of brigade observers was demonstrated during the October twenty-sixth assault against Bellevue Spur, an important piece of high ground needed as a base for future assaults. At one point, when the battle looked as if the assault had failed, brigade observers from the left attacking brigade “insisted that men of the Right Brigade were still to be seen on the Crest of BELLEVUE,” even though “all other reports indicated that the right Brigade troops were back in their J.O.T. [jumping off trenches].”²⁷ “This information at that time was invaluable,” for it meant the assault could still be salvaged. Units from the supporting battalion were sent forward to help clear up the situation and to join forces with the men holding out on the ridge, with the result that “the Spur was completely in our possession by the afternoon.”²⁸ The effort involved in maintaining brigade observers had paid off handsomely.

²⁵ NAC, M.G. 30 E 100 (Currie Papers) Vol. 36, Folder 164. Canadian Corps to 2nd Army, November 16, 1917.

²⁶ NAC, M.G. 30 E100 (Currie Papers) Vol. 36, File 162. 7th Brigade report.

²⁷ Their reports were later confirmed by a airplane contact patrol.

²⁸ NAC, R.G. 9 III C1, Vol. 3853, Folder 68, File 7. “Intelligence, 3rd Canadian Division, For Bellevue Spur Operations of 26th and 30th October, 1917,” November 8, 1917.

The Canadians also used corps-level observers at Passchendaele. They had their own OPs, and collected “valuable information” “throughout all operations.”²⁹ The use of corps OPs was a new development, and added an extra layer of observers to those already operating in brigades and battalions.³⁰ Corps OPs gave corps headquarters its own team of intelligence gatherers from whom the commander could quickly learn about the situation at the front, as they “were sited to obtain the best general view of the area of operations.” They used telephones and lamp signals to relay messages to corps headquarters.³¹ When combined with other sources of information, such as artillery liaison officers, brigade observers, FOOs and the RFC, the corps observers increased the corps’ ability to react and respond to the latest information.³²

The job of the observers following the action was made easier by the infantry’s use of flares or Very Lights to mark certain stages reached in the advance, or when calling for assistance. During the November tenth assault, for example, units in the 5th Brigade fired three white Very Lights in quick succession “to denote the capture of the objective.”³³ Throughout Canadian operations the SOS signal was “a rifle grenade signal showing three parachute lights” (red over

²⁹ NAC, M.G. 30 E 100 (Currie Papers) Vol. 36, Folder 164. Canadian Corps to 2nd Army, November 16, 1917.

³⁰ J.E. Hahn, *The Intelligence Service*, 255.

³¹ NAC, M.G. 30 E 100 (Currie Papers) Vol. 36, Folder 164. Canadian Corps to 2nd Army, November 16, 1917.

³² At Passchendaele most of the men for the corps posts came from the corps cavalry. Beginning in early 1918, observers could also be drawn from the British Lovat Scouts organization, although the Canadian command tended to rely on their own men rather than on the Lovat Scouts. Lovat Scouts were highly trained in the arts of scouting, sniping, and observation. Any level of command within a corps could, upon application, obtain the assistance of Lovat Scouts for specific tasks, but their principal duty was corps observation work. In 1918, all British corps began organizing corps observation sections. NAC, M.G. 30 E100 (Currie Papers) Vol. 36, File 164. Canadian Corps to 2nd Army (Intelligence), November 16, 1917; Major H. Hesketh-Prichard, *Sniping in France. How the British Army Won the Sniping War in the Trenches* (19?, USA: Lancer Militaria, 1993), 99-103.

³³ The lights were fired only on the orders of company commanders.

green over yellow). Since the forward most troops firing the SOS signal might be out of sight to ground observers, the corps advised that a series of SOS relay posts be built “to repeat the signal from the front line back to Supporting Battalions and Artillery.”³⁴

The artillery needed information during the battle, too. Artillery observers, along with liaison officers, helped regulate the speed of the creeping barrage to ensure that it did not get too far ahead of the advancing infantry it was protecting. During the advance, as the infantry reached their objectives, divisional artillery FOOs established forward posts. Every effort was made to link these posts to the guns by telephone, but lamps and pigeons were available should they be required. The FOOs worked in a relay team fashion, with the FOOs at the forward-most posts sending news to other FOOs stationed further back, the number of such relay centres depending on the distance and the nature of the ground covered. Each relay post sent in reports on enemy movement and activity, and “in this way each relay station was an O.P.”³⁵ FOOs observing for the heavy artillery also had the use of wireless, giving those guns immediate access to information concerning opportunity targets. Some of the FOOs working with the field artillery could also use corps wireless sets for calling in news when those sets were situated near their posts.³⁶ The results of these arrangements were generally favourable, although different units had different experiences. The 1st Battalion was very pleased with

³⁴ NAC, R.G. 9 III C1, Vol. 3908, Folder 28, File 8. The “Canadian Corps Instructions for the Offensive Passchendaele No. 1,” October 23, 1917; R.G. 9 III C3, Vol. 4118, Folder 2, File 7. 22nd Battalion Operation Order No. [181?], November 4, 1917.

³⁵ NAC, R.G. 24, Vol. 1832, Folder: GAQ 8-15d. “Canadian Corps Artillery Report on Passchendaele Operations Oct. 17th to Nov. 18th 1917.”

³⁶ NAC, R.G. 9 III C1, Vol. 3908, Folder 30, File 3. “1st Canadian Divisional Artillery. Summary of Field Artillery Forward Communications for Attack (9),” November 9, 1917. Bill Rawling, “Communications in the Canadian Corps, 1915 - 1918: Wartime Technological Progress Revisited,” *Canadian Military History* 3.2 (Autumn 1994), 16.

its artillery support, saying bombardments were always “prompt and effective.”³⁷ The 52nd Battalion, on the other hand, found that the FOO working near it was in the way a great deal, kept the telephone lines tied up, was in a position “where he could see nothing in front of our line,” and on the whole was of little value.³⁸ For the most part, though, FOOs were usually in a position to see the action and were, as a consequence, a valued source of tactical information.³⁹

Currie also expected his infantry commanders, along with their staffs, to collect information first hand. Indeed, given the difficulties of sending back news from the front over mud-covered fields swept by enemy machine guns and artillery fire, Canadian Corps headquarters felt compelled to remind brigade and divisional staffs of their responsibility and duty to go forward and “find out for themselves” what conditions were like at the front if battalions were unable to provide them with complete and coherent information.⁴⁰ Currie believed that brigade commanders, ideally, should “be in a position where [they] can see for [themselves] the course of the action” in order that they might better influence its outcome. He realized, though, that this was difficult to do in practice, but believed that, at the very least, commanders of reserve units should be in such positions, where they could “be ready to act on [their] own initiative without waiting for orders.” In fact, something similar to this happened during the October twenty-sixth assault against the Bellevue Spur, and it caught Currie’s attention. He wrote:

The O.C. [of the 1st] Battalion [in reserve] had, with his Company Commanders, taken up a position on the GRAVENSTAFEL RIDGE, whence he could watch the development of the action and

³⁷ NAC, R.G. 9 III C3, Vol. 4033, Folder 3, File 3. 1st Battalion report on Passchendaele.

³⁸ NAC, R.G. 9 III C3, Vol. 4188, Folder 6, File 2. Report by signal officer, 52nd Battalion, November 18, 1918.

³⁹ Rawling, *Surviving Trench Warfare*, 157.

⁴⁰ NAC, R.G. 9 III C1, Vol. 3908, Folder 28, File 8. “Canadian Corps Instructions for the Offensive Passchendaele No. 1,” October 23, 1917.

noticed where the German barrage was falling heaviest. Consequently on receiving the order to support the leading battalions [on Bellevue Spur] he was able promptly to direct his companies by the best routes onto the place where they were most wanted, and succeeded in reaching the remnants of the leading battalions, which were still clinging to the crest of the Spur.⁴¹

The result of this effort, as we have seen, was the capture of the Spur by that afternoon.

Liaison officers were widely used at Passchendaele, and their efforts helped coordinate the advance. Liaison officers from both the heavy and field artillery were with the infantry brigades in the line. The field artillery also had officers with each battalion "for the purpose of keeping their own Batteries and Brigades informed of the general situation," and for checking cases of short shooting.⁴² The various artillery liaison officers normally had direct telephone lines to their guns, but could still use visual signal or runner if need be. The 1st Battalion reported how the artillery officer stationed at its headquarters "was most energetic and passed on valuable information to his group."⁴³ There were exceptions, of course, and in the 52nd Battalion the LOs stationed there were without telephone connections for two days.⁴⁴ For the most part, liaison arrangements were successful, and on those occasions they helped link the assaulting units together. Infantry commands also exchanged officers with their neighbours.⁴⁵ Company and platoon officers kept in touch with battalion headquarters in person. After the

⁴¹ NAC, R.G. 9 III C1, Vol. 3854, Folder 71, File 7. Canadian Corps to 2nd Army, November 20, 1917.

⁴² NAC, M.G. 30 E6 (Burstall Papers) Vol. 2, Folder 11. "2nd Canadian Division Instructions for the Capture of Passchendaele," November 2, 1917.

⁴³ NAC, R.G. 9 III C3, Vol. 4033, Folder 3, File 3. 1st Battalion Report on Passchendaele.

⁴⁴ NAC, R.G. 9 III C1, Vol. 3908, Folder 30, File 3. "1st Canadian Divisional Artillery. Summary of Field Artillery Forward Communications for Attack (9)," November 9, 1917; R.G. 9 III C3, Vol. 4188, Folder 6, File 2. Signal officer, 52nd Battalion to the Officer Commanding, November 18, 1917.

⁴⁵ NAC, R.G. 9 III C3, Vol. 4052, Folder 21, File 3. 2nd Brigade Operation Order No. 246, November 7, 1917.

battle, reports on the work of the various LOs were generally favourable. The 7th Brigade commander said, for example, that “Lastly I must express my appreciation of the Liaison Officers of the various Arms; their attention and interest in their work and their prompt action when required were most acceptable.”⁴⁶

Machine gunners and trench mortar crews kept in touch, too. Trench mortar crews followed the leading infantry assault waves, and personally kept in touch with the infantry they were supporting. But owing to difficulties of re-supplying ammunition to the trench mortar crews, trench mortars were sometimes of little value at Passchendaele. The lighter Stokes guns, however, were more effective. The 1st Battalion recorded how during its advance “One Stokes Gun and two crews were taken forward and came into action at GRAF HOUSE where admirable work was done by Lieut. J.D. COTTON, 1st Canadian Trench Mortar Battery in reducing this strong point.”⁴⁷ More important, still, were the machine guns. They also followed behind the infantry and took up defensive positions within the captured ground where they were crucial for beating off counter attacks, especially when friendly artillery was unavailable.⁴⁸ Machine gun group commanders worked out of the infantry brigade headquarters their guns were affiliated with, and were “responsible that close liaison [was] established and maintained with their batteries throughout the operation.” It was through this officer that the infantry’s tactical desires for machine gun use were carried out.⁴⁹

⁴⁶ NAC, M.G. 30 E100 (Currie Papers) Vol. 36, File 162. 7th Brigade report.

⁴⁷ NAC, R.G. 9 III C3, Vol. 4033, Folder 3, File 3. 1st Battalion Report on Passchendaele.

⁴⁸ Rawling, *Surviving Trench Warfare*, 153 - 154.

⁴⁹ NAC, R.G. 9 III C1, Vol. 3852, Folder 65, File 10. “Action of Massed Machine Guns,” part of Operation Order No. 165, November 4, 1917; Folder 65, File 11. “Action of Massed Machine Guns,” part of Operation Order No. 159, October 23, 1917. Runners were used to keep in touch with the batteries. See also Vol. 3853, Folder 68, File 4. “2nd Canadian Division Instructions for the Capture of Passchendaele,” November 2, 1917.

Overhead the RFC proved its worth once again in gathering and relaying news on the battle raging below (the weather always seemed to clear as Z Day wore on). Contact air patrols, always helpful in locating friendly positions after an advance, took on new importance at Passchendaele because of communication slowdowns due to mud. Corps headquarters also reminded the infantry of "The extreme importance of communicating their position" to the aircraft flying above. This was "impressed upon all units," for "one of the chief difficulties in the present type of fighting is the accurate location of our own front line, and unless the Infantry make their position known they cannot expect effective support from our artillery in case of emergency."⁵⁰ This was an opinion shared by the 1st Division when it said that contact patrols must be answered, "This is the only really accurate means of establishing the location of our line."⁵¹ Battalion headquarters could also send and receive information to planes using special signalling equipment.⁵² To help the aerial observers in their reconnaissance, "Close liaison was maintained throughout the operations, [with] the O.C. Squadron visiting Corps H.Q. each evening to discuss the general situation, the work carried out during the day, and the work required for the next day." Meanwhile "Pilots and Observers of contact patrol machines visited divisions the day before the attack to receive any special instructions." The squadron headquarters also "called up the General Staff and obtained the latest information regarding the situation" whenever a contact patrol was about to fly; and "Whenever weather conditions permitted[,] photographs of the line reached by our troops were taken on the afternoon of the attack, when

⁵⁰ NAC, R.G. 9 III C3, Vol. 4148, Folder 12, File 3. "Princess Patricia's Canadian Light Infantry, Secret 'B', Instructions for the Offensive No. 2;" also 7th Brigade's "Instructions for Offensive No. 3," October 26, 1917.

⁵¹ NAC, M.G. 30 E15 (Griesbach Papers) Vol. 5, File 29. "1st Division Report on Passchendaele Ridge Operations November 4 - 12, 1917."

⁵² NAC, R.G. 9 III C3, Vol. 4148, Folder 12, File 3. "Princess Patricia's Canadian Light Infantry, Narrative of Operations October 28th, 29th, 30th, 31st and November 1st 1917."

photos were not possible an attempt was made to carry out a special low reconnaissance.”

In addition to contact patrols, the RFC searched for enemy troop concentrations and counter attack forces. Counter attack patrols relayed their sightings to the gunners for immediate action.⁵³ Here the counter battery organization, with its intricate system for rapidly collecting, compiling and disseminating intelligence, was instrumental, as it helped gunners from across the front respond quickly to reports from pilots and ground troops that German soldiers were seen forming up or on the move.⁵⁴

The RFC's attempts to aid the counter battery effort, however, were hampered by poor weather and German fighters. Nevertheless, when it was airborne the Corps Squadron managed to perform valuable service, and on those occasions “Practically the whole of the Counter Battery Intelligence” effort was based on their reports. During the various Canadian assaults, and “despite unfavourable weather” that at times “completely neutralized” the RFC's efforts, pilots “were able to send sufficient Zone calls to clear up the Hostile Artillery situation.”⁵⁵ Unfortunately, those enemy batteries that managed to survive, and there were many at Passchendaele, caused considerable consternation amongst the advancing infantry, and managed to hold up attacks, sometimes prevented the

⁵³ NAC, R.G. 9 III C1, Vol. 3908, Folder 28, File 8. “Canadian Corps Instructions for the Offensive Passchendaele No. 1,” October 23, 1917. See also Vol. 3853, Folder 68, File 4. “2nd Canadian Division Instructions for the Capture of Passchendaele,” November 2, 1917, and R.G. 9 III C3, Vol. 4052, Folder 21, File 3. Operation Order 246, 2nd Brigade, November 7, 1917 for similar details.

⁵⁴ G.W.L. Nicholson, *The Gunners of Canada. The History of the Royal Regiment of Canadian Artillery, Vol. 1, 1534 - 1919* (Toronto: McClelland & Stewart, 1967), 308 - 309; John Swettenham, *McNaughton, Vol. 1, 1887 - 1939* (Toronto: The Ryerson Press, 1968), 114.

⁵⁵ NAC, R.G. 24, Vol. 1832, Folder: GAQ 8-15d. “Canadian Corps Artillery Report in Passchendaele Operations Oct. 17th to Nov. 18th 1917;” R.G. 9 III C1, Vol. 3922, Folder 9, File 2. “Counter Battery Work In The Passchendaele Operations. October 17th. -- November 18th. 1917.”

capture of objectives, and inflicted severe casualties on the Canadian ranks. Still, the corps was quite pleased with the work of the RFC throughout operations, stating to the 2nd Army that it could not recommend any form of improvement to the system as it then stood.⁵⁶

Intelligence collected during the battle was of little use if the necessary channels of communication were not in place for transmitting it, or were deficient in some way. To ensure that information was passed to those who required it demanded an enormous effort at all levels of command. Battalions used pigeons, lamps, visual signals, runners, power buzzers, Fullerphones, and telephones. The idea behind using such a variety of methods was to increase the odds that one or another system of communicating would survive to carry news. A communications grid tied the whole communications-intelligence complex together, and a series of reports centres were used as at Vimy Ridge and Hill 70 to carry the grid forward in the attack. Messages dogs were tried by some battalions, although their use was less than successful. The troops made pets out of them, while the 52nd Battalion noticed that the dogs were "very terrified under shell fire, and when released from H.Q., refused to leave." Regardless of the communications method used, brigades expected their battalions to make every effort to keep them "in touch with the situation at all times," and immediately upon capturing their objectives to send back disposition reports and maps (blank copies of which were distributed to the battalions prior to the advance) recording the situation as it then stood.

Similar communications arrangements were available to commands lying behind battalion headquarters. Telephones connected each brigade report centre to

⁵⁶ NAC, M.G. 30 E 100 (Currie Papers) Vol. 36, Folder 164. Canadian Corps to 2nd Army, November 16, 1917. The 1st Division noted the successful contact patrols during its November sixth assault, saying "The report [of the contact patrol] was of great assistance in verifying the location of the Infantry. Later, rain made flying impossible." See M.G. 30 E15 (Griesbach Papers) Vol. 5, File 29. "1st Division Report on Passchendaele Ridge Operations November 4 - 12, 1917."

each battalion headquarters, and were, likewise, connected to rear area report centres and artillery headquarters (by telephone, wireless, pigeons, visual signals, Power Buzzers, despatch riders, and runners). The artillery, too, established forward report centres that its liaison officers and FOOs could contact with news concerning conditions at the front (wireless was available to heavy artillery FOOs). Overhead, the Corps Squadron reported on the progress of the infantry to the gunners and rear area commanders by message drop or wireless transmission.⁵⁷

The major intelligence failure at Passchendaele concerned counter battery intelligence. Too many German guns went undetected and survived Canadian counter battery efforts. The result was that the infantry suffered heavy losses due to enemy artillery action. There were a number of reasons for the poor counter battery performance. For one, aggressive German pilots, flying superior aircraft, dominated the skies, and often forced Allied artillery spotters to the ground. Secondly, as the report on "Counter Battery Work In The Passchendaele Operations" points out, no "effective use" could be made of the high ground captured by the Canadians due to limited views and poor visibility attained from those positions. On other occasions, such as during the November sixth assault, Canadian counter battery observation posts were targets of enemy guns, and "For this reason the full advantage of the high ground was not obtained, and Hostile Batteries were able to remain in action." Thirdly, poor weather conditions, which one Canadian Corps report said reduced counter battery intelligence collection to "practically nil," grounded the RFC much of the time. Finally, McNaughton, the CBSO, was convinced that the main reason the heavy artillery lacked targets was

⁵⁷ NAC, R.G. 9 III C3, Vol. 4188, Folder 6, File 2. Report by signal officer, 52nd Battalion, November 18, 1917; Vol. 4052, Folder 21, File 3. 2nd Brigade Operation Order No. 246, November 7, 1917; R.G. 24, Vol. 1832, Folder: GAQ 8-15d. "Canadian Corps Artillery Report on Passchendaele Operations Oct. 17th to Nov. 18th 1917;" Rawling, "Communications in the Canadian Corps," 16.

due to the poor work of the army controlled sound rangers and flash spotters.⁵⁸ McNaughton's main criticism was that it took too long for flash spotters and sound rangers to reestablish themselves after an advance -- a situation unacceptable when waging a series of rapid blows. The delicacy of the equipment was at fault, and it was sometimes several days before sound rangers and flash spotters could reposition themselves. This meant that they played only a limited role in locating German batteries during the Canadian portion of the Passchendaele campaign, and since the RFC was grounded much of the time, the absence of the sound rangers and flash spotters was keenly felt. Major-General Sir Edward Morrison, commander of the corps artillery, concurred with McNaughton, and both put the blame for their sluggish performance on their organization structure. As these men saw it, the Survey Sections (the umbrella organization that controlled the flash spotters and sound rangers), by not being under direct artillery control were less than fully responsive to the gunners' intelligence needs. "The failure of the Survey Sections [McNaughton wrote, and Morrison echoed] illustrates once more the fallacy of carrying out this work under control of a Non-fighting Branch, whose real business is preparing and printing maps." In short, the counter battery effort failed for want of counter battery intelligence. Considering how important counter

⁵⁸ There may be some confusion over the various terms used to describe army flash spotters and sound rangers. As John Innes notes in his book *Flash Spotters and Sound Rangers. How They Lived, Worked and Fought in the Great War* (London: George Allen & Unwin Ltd., 1935), 12, "Flash Spotting Groups and Sound Ranging Sections were detachments of the Field Survey Battalions, R.E." Flash spotting, however, was not an official term, and at different times these groups of men "were named Artillery Survey Sections, Artillery Survey Detachments, Observation Sections, and, finally, Observation Groups." Sound rangers, happily, were always known as Sound Ranging Sections. However, Field Survey Battalions were not always called such, having gone through evolutionary name changes that included 1st Ranging and Survey Section, R.E., Topographical Sections, R.E., Field Survey Companies, and Finally Field Survey Battalions. If this is not confusing enough, these units were best known at the time by their code name 'Maps.'

battery fire was to the success of Canadian operations, this lack of target information was critical, and made success far more difficult to achieve.⁵⁹

Not everyone agreed with McNaughton's and Morrison's appraisal. Coming to the defence of the Survey Sections was John Innes in his 1935 publication *Flash Spotters and Sound Rangers*. Innes had served with the Survey Sections during the war, and although he agreed that the performance of the sound rangers and flash spotters fell well short of spectacular at Passchendaele, he offers a different reason from that of McNaughton and Morrison.

At Passchendaele, our artillery commanders, without much experience of the techniques of Flash Spotting or Sound Ranging, insisted on these Sections being pushed up close to the line. The result was that neither the Groups nor the Sections could keep their telephone lines working and so they were not able to 'deliver the goods.' The Counter Battery Office had to fall back on information obtained solely from the air, with the result that the German artillery was largely unmolested, and the feature of this battle was the damage done by the enemy gun fire.⁶⁰

In other words, criticizing the Survey Sections for not keeping pace with the advance was a red herring; flash spotters and sound rangers did not necessarily need to move forward to do their job. So long as they could see flashes and record sound waves they could remain put. None of this helped the infantry on the ground of course, who continued to suffer the effects of unmolested German batteries.

The intelligence system had, nevertheless, played an important role in the Canadian success at Passchendaele. After the battle, Major-General L.J. Lipsett, commander of the 3rd Division, wrote: "In my opinion good Intelligence and

⁵⁹ NAC, R.G. 9 III C1, Vol. 3922, Folder 9, File 2. "Counter Battery Work In The Passchendaele Operations. October 17th. -- November 18th. 1917." Survey sections were manned largely by Engineers, and were administered by the Topographical and Maps Section, or Intelligence (c), at GHQ; R.G. 24, Vol. 1832, Folder: GAQ 8-15d. "Canadian Corps Artillery Report in Passchendaele Operations Oct. 17th to Nov. 18th 1917."

⁶⁰ Innes, *Flash Spotters and Sound Rangers*, 79.

reconnaissance is absolutely necessary to ensure success,” and that at Passchendaele “The method of Intelligence worked very well, the information of the enemy’s defences and dispositions was very complete: we got good information from our O.Ps; the liaison with the Artillery was very smooth.”⁶¹ The Canadians had prepared plans and artillery programs from the latest information, while assaulting troops learned something of their task, of the enemy’s defences, and of the terrain they had to cross from their study of maps, photographs and other intelligence. Based on what they knew of German defensive techniques, the Canadians studied how best to bust a pillbox and proceed over machine gun swept terrain. Machine guns, artillery, and trench mortars joined in harassing fire programs that aimed to disrupt German activity in sensitive areas in and behind the German lines. Bombardments and barrages also proceeded from the information available on German defensive layouts and known strong points. The forward movement of the infantry and its supporting arms had been worked out as best it could prior to each assault (although planners knew full well that unforeseen obstacles were bound to crop up). But even when facing the unknown, intelligence played a vital role. Working in tandem with the signals personnel struggling to maintain the communications system, intelligence gatherers helped keep rear area decision-makers informed of events at the front, which helped compensate for the gaps of knowledge in the original plan. This was crucial, for without such news the supporting arms could not effectively engage strong points and other obstacles blocking the Canadians’ path. In the case of counter battery fire, the ability of the counter battery organization to respond instantly to reports of enemy troop concentrations and active hostile batteries offset, to some degree, their lack of

⁶¹ NAC, R.G. 9 III C1, Vol. 3853, Folder 68, File 7. 3rd Division to Canadian Corps, November 9, 1917. Lipsett added: “Our Intelligence Branch is stronger than in Imperial Divisions, but I do not think that too many Officers are employed in it for this Branch can be of the greatest service.”

intelligence before the assault. The intelligence – communications system, in other words, helped turn the Canadian Corps into a more responsive force, able to change with the circumstances on the ground. This did not mean the fighting was easy, for the price of success was high at Passchendaele (16,000 casualties); yet there was success, and at a place where other British efforts had failed.

CHAPTER ELEVEN

THE EMERGENCE OF OPEN WARFARE: SPRING AND SUMMER 1918

In 1918 the Canadian Corps adjusted its assault techniques and intelligence system. A number of German and Allied experiences in 1917 suggested greater fluidity in battle was possible.¹ The German 1918 Spring Offensive showed that this was indeed the case. To cope with the changed conditions, the Canadians needed better tactics, greater all-arms cooperation, and a smoother, more timely flow of intelligence. Before they could practice the necessary techniques, however, they had to prepare to meet the German spring onslaught, launched March 21, 1918. This offensive was expected by the Allies. Shored up by divisions from the Eastern Front, where the German Armies had recently knocked the Russians out of the war, the Germans decided their best chance for victory in the west was to launch an early offensive in 1918 to win the war before the large influx of American troops made their presence felt. This massive shifting of fifty German divisions from one front to the other did not go unnoticed by the Allies, and so they expected a major German initiative at some early date. The problem was in determining when and where the blow would fall.

Currie considered the Vimy sector, defended by the Canadian Corps, a prime target for a German offensive. This was despite the natural strength of the

¹ British experiences at Cambrai in November 1917, and German experiences at Riga in the summer of 1917, for example, suggested mobile warfare, with its increased fluidity, deeper penetrations and potential breakthrough opportunities was possible with the right combination of fire-power, tactics and planning.

position, and the fact that the Canadians had turned the Vimy sector into a fortress. Currie was concerned, nonetheless, and noted after the war that even slight gains in this area would have stopped coal production behind the Canadian front, “paralysing the production of war material in France.” A deep penetration around Vimy “would have placed the British Army in a critical position, by threatening to cut it in two and by depriving it of vital lateral communication.” In fact, the tactical and strategic gains possible along the Vimy front from even a moderate success were so significant that “it was fully expected that the German offensive would be directed against this, the central part of the British front.” To meet this threat, defences were strengthened and deepened so “that the loss of ground at any one point could be localised and...not cause a forced retirement from adjoining areas.”²

The Canadian intelligence organization did its part in trying to determine with certainty the likelihood of the Canadian front being the target of the German drive. Through raids, wireless intercept, aerial and ground observation, and the examination of prisoners and documents, the Canadians helped GHQ build and track the German order of battle. General Headquarters, in turn, used this information to predict German actions. The study of the enemy’s artillery dispositions, shelling patterns and habits also shed light on German aggressiveness, which helped determine the likelihood of the Vimy front being the object of German ambitions. To cite one example of how this was done, in February 1918 the CBSO determined that there were 230 gun pits opposite the Canadian Corps, but that at most 144 pits were actually occupied. This represented a maximum of 350 guns aligned against the corps. Of this total, he estimated that 148 guns were heavies, while 212 he thought to be lighter field guns. The minimum number of pits thought occupied was sixty-one, representing 152 guns

² Arthur Currie, “Canadian Corps Operations. Synopsis: Interim Report,” *Report of the Ministry, Overseas Military Forces of Canada 1918* (London: King’s Printer, 1919), 104 - 105.

(sixty-nine heavies, and eighty-three field guns). To arrive at these figures required a colossal intelligence effort. By examining POW statements, captured documents, and so forth, the German order of battle opposite the corps was worked out. The German order of battle told the Canadians the number of German divisions facing them, and knowing the number and type of guns contained in a German division, the Canadian CBO estimated the number of guns facing the corps. The next task was to locate these guns, which is where flash spotters, sound rangers and aerial observation came into play. Then by calculating ranges and arcs of fire, and by studying German shelling patterns (i.e., What targets interested them? Were they mainly employing harassing fire or destructive shoots?) over the previous weeks and months, he determined something of their aggressiveness. In this particular case, the CBSO concluded that German shelling was reminiscent of a "normal" or a "normal - quiet" sector.³

This did not mean the corps was safe. The problem with the above calculations, and one recognized at the time, was that they did not include any extra guns the Germans may have deployed in the area and kept silent and camouflaged. Other intelligence had to be reviewed before any definite conclusions regarding German capabilities were reached. For example, throughout February and March the Canadians noticed that although the Germans were not strengthening their defences, they were repairing roads and railways. Aerial photographs also revealed an increasing number of engineer and ammunition dumps proliferating in back areas. Aggressive German raiding carried on throughout February, along with their frequent gas shellings and destructive shoots suggested they were preparing the corps front for assault. Meanwhile, "Fresh Battery positions were appearing

³ National Archives of Canada (NAC), Record Group (R.G.) 9 III C1, Vol. 3920, Folder 2, File 7. Counter Battery Office to G.O.C., R.A. Canadian Corps, "Probable Amount of German Artillery opposite Canadian Corps Front," February 14, 1918.

almost daily.” The increase in German fighter patrols and the number of anti-aircraft batteries in the sector all pointed to offensive operations, and by early March the Canadians estimated that all German preparations were ready. Although the Canadians did not detect any new German troops, they believed that these could be easily concealed in the numerous towns in the area. Adding to Canadian anxieties were prisoner reports confirming that all German divisions were up to strength “and undergoing hard training in the tactics of open warfare.” When the German blow finally fell against the British 5th Army, it by-passed the Canadian Corps. Still, constant vigilance was required of the intelligence organization, as the corps “was dependent on the efficiency of this branch of the service for timely warning against surprise attacks.”⁴

Until the German tide breaking over the front subsided, the Canadians could not relax. Much thought, for example, went into the placement of Canadian artillery observation posts. The 4th Division commented that “In view of the possibility of the enemy attacking our present Sector in force, and penetrating our defences sufficiently to capture the high ground where our O.P’s are located at present, it is essential, [sic] that we select alternative O.P’s.” Contingency plans were necessary for replacing FOOs should they be overrun. Every officer, too, was reminded “of the utmost importance” of keeping in “close touch with the Infantry.” Since a German attack could come without warning, divisional headquarters collected “every scrap of information” so “that it may be acted upon immediately or passed on to Divisional Artillery Headquarters” for their response.⁵ Fog and misty weather demanded extra vigilance, as recent German assaults showed they liked to attack under these conditions. In May, the 4th Brigade, “In view of the increased enemy activity along this front,” wanted careful and

⁴ Currie, “Canadian Corps Operations,” 107 - 108.

⁵ NAC, R.G. 9 III C4, Vol. 4278, Folder 12, File 14. Lieutenant Colonel commanding Right Group, 4th Divisional Artillery, to batteries, April 15, 1918.

continuous observation carried on throughout the formation. Forward observers noted all movement, recorded enemy flag signals, and carefully watched German trench mortar activity, recording each round fired. Observers also looked for any bridging of trenches, and Red Cross Flags (an increase in the number of medical units suggested an offensive), and counted the number of German ammunition dumps exploding due to Canadian artillery fire. In other words, vigilance was required at all times.⁶

While they were watching the German build-up, the British and Canadians were thinking about open warfare. Ever since Passchendaele, GHQ and corps headquarters had suggested the need for some training in open warfare “if only to bring home to Officers the necessity that arises in such circumstances for quick decision and the prompt issue of orders.” Their fear was that trench warfare had atrophied “the power of a Commander to issue orders without hesitation and the ability of a subordinate either to act on such orders intelligently or, failing the receipt of orders, to act on his own initiative in accordance with the immediate necessities of the situation.” This was because “In trench warfare nearly all plans are settled after conferences held at leisure, and [after] considerable discussion with subordinates.”⁷ In open warfare, in contrast, officers had to think on their feet. The First Army emphasized this belief in May, when it wrote in relation to machine gun tactics:

Machine Gun Battalion Commanders must strongly impress on all their subordinates, the vital importance of initiative, good judgement and ruthless energy and driving power. It must be realised that highly organised trench warfare has tended to check the qualities of initiative, leadership and self-reliance on the part of subordinate commanders. Recent operations which have been operations of

⁶ NAC, R.G. 9 III C3, Vol. 4105, Folder 19, File 3. 4th Brigade to battalions, May 29, 1918; Folder 20, File 2. Canadian Corps to 2nd Division, April 10, 1918.

⁷ NAC, R.G. 9 III C3, Vol. 4064, Folder 15, File 6. “Canadian Corps Notes on Training,” issued November 27, 1917.

movement rather than of position have demonstrated the great importance of such qualities.⁸

This is not to argue that the Canadians believed the end of trench warfare was in sight; the corps' November 1917 "Notes on Training" thought that some mix of trench and open warfare likely.

It frequently appears to be thought [explains the Notes] that trench warfare and open warfare are two entirely different things and that, at a given moment, we shall pass from one to another for good and all. In the first place, it is unlikely that on the Western front there can ever be a long period of freedom from trench warfare, for, even after a rapid advance, such as might be occasioned by a break through on a portion of the front, the tendency must be towards a freezing up of the battle front again sooner or later. What we have to prepare for, then, is the period of transition from the first phase to the second, and back again to the first.⁹

What this meant, of course, was that the procedures necessary for winning open warfare had to be learned and mastered concurrently with the techniques necessary for winning trench warfare.

It was not until about May that the Canadians began training for open warfare in earnest, but once they started they embarked on an intensive training program emphasizing offensive tactics. The principles of fire and movement, infiltration, junior officer initiative, and the all-arms battle were stressed. The infantry rehearsed section tactics that saw the men advance to their objectives in bounds. Rapid consolidation, contact patrol work, and specialist training (for Lewis gunners and bombers, for example), along with the staples of infantry training: musketry, bayonet work, and physical training, lay at the heart of infantry training in 1918. "[T]ranslations of captured German documents bearing on the

⁸ NAC, Manuscript Group (M.G.) 30 E100 (Currie Papers) Vol. 37, File 167. "First Army Policy Regarding the Employment of Machine Guns," May 10, 1918.

⁹ NAC, R.G. 9 III C3, Vol. 4064, Folder 15, File 6. "Canadian Corps Notes on Training," issued November 27, 1917.

latest tactics, and supplemented...by [GHQs'] 'Notes on Recent Fighting'...inspired [their] training." And as past Canadian successes had depended on the crushing power of artillery, open warfare, with its deeper penetrations, required the guns be practiced in rapidly moving forward in order to maintain support for the assaulting troops. Likewise, tanks, the RAF, balloon sections, trench mortars, and machine guns all practiced their supporting roles.¹⁰

The increased distances that assaults now achieved demanded far more of the liaison and communications arrangements than was the case during trench warfare. These were vital for ensuring close cooperation between the infantry and its supporting arms. The First Army, for example, made clear the importance of liaison to the moving battle in its policy statement concerning the employment of machine guns referred to earlier.

In a moving battle the importance of liaison is greatly increased. On it depends the regulation of the alternate advances of Infantry and Machine Gun Units, the opportune application of Machine Gun fire to support the Infantry, and, in extreme cases, the reinforcement of the firing line by Machine Guns to obtain definite superiority of fire over the enemy.

But liaison was not in one direction.

At all times Officers Commanding Machine Gun Units should be constantly on the alert to seize any opportunity of assisting the Infantry and of inflicting losses on the enemy. Machine Gun Officers must be thoroughly in touch with all matters affecting their front, and it is the duty of Infantry Commanders to keep them informed of all changes and developments of the situation which may affect their action.¹¹

Figure 11.1: "1st Canadian Division Attack On Machine Gun Nest," shows how

¹⁰ Currie, "Canadian Corps Operations," 123 -124.

¹¹ NAC, M.G. 30 E100 (Currie Papers) Vol. 37, File 167. "First Army Policy Regarding the Employment of Machine Guns," May 10, 1918.

Figure 11.1: 1st Canadian Division Attack On Machine Gun Nest¹²

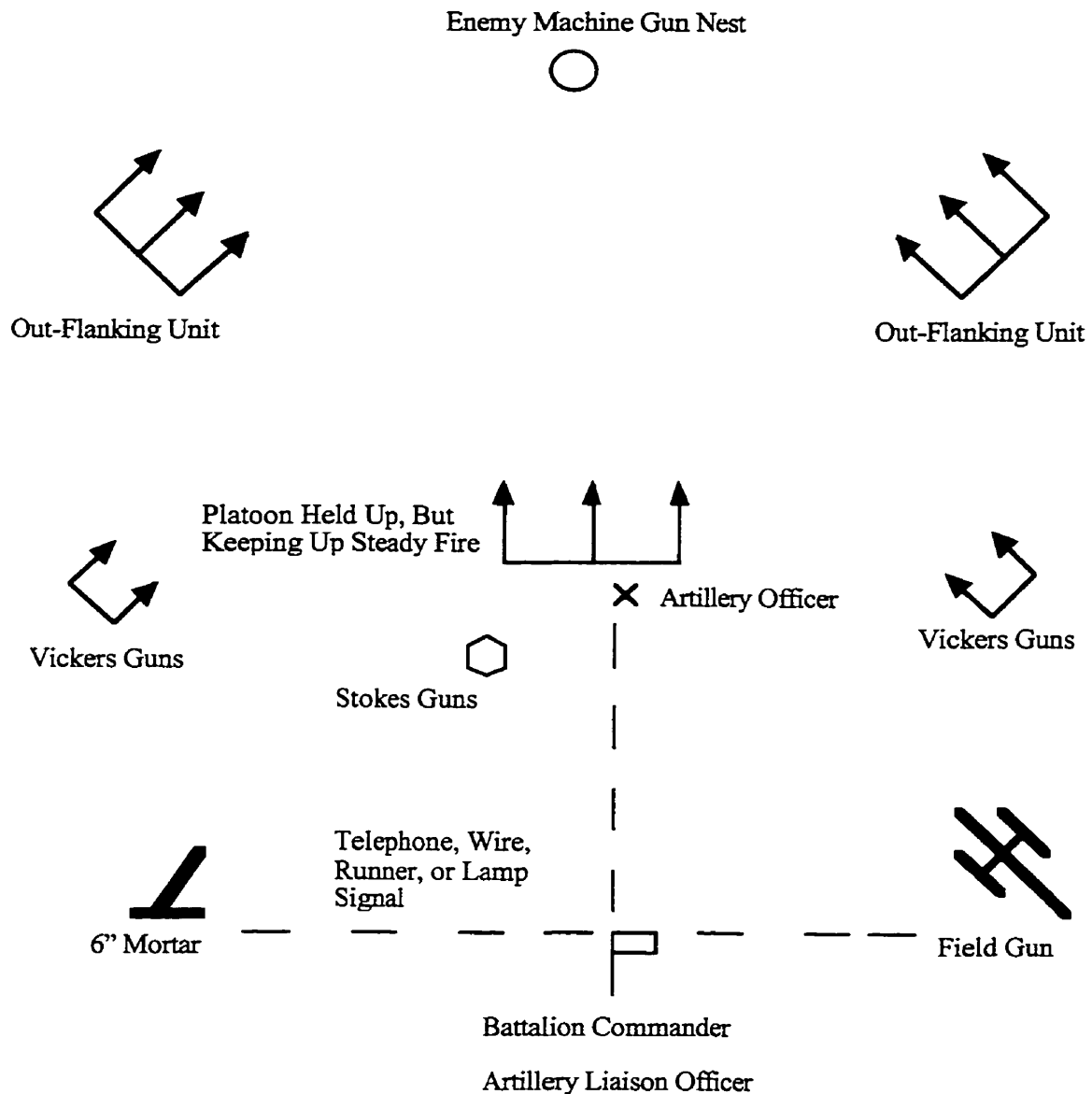

¹² This diagram is largely a reproduction of the one found in NAC, M.G. 30 E100 (Currie Papers) Vol. 37, File 167. 1st Division to subordinates regarding tactical exercise in removing hostile machine gun nests, June 24, 1918. The crews of the Vickers and Stokes Guns kept in personal touch with the nearby infantry in a face-to-face fashion.

the 1st Division envisioned information flow and tactics working together at the battalion level of command when facing a hostile machine gun. For the purposes of this June 1918 exercise, battalions had a section of field artillery, along with light and medium mortars, working with them. As the diagram shows, coordinating their actions with those of the assaulting infantry depended on good liaison and communications.

Continuing with the machine gun example, in the Canadian Corps the machine gun battalions maintained touch by placing their company and battery commanders at the headquarters of the infantry brigades and battalions they were supporting. Machine gun section commanders kept in personal touch with the infantry units in their surrounding area.¹³ During the more quiet periods, when trench warfare set in, machine gunners continued to collect intelligence. According to the Canadian Corps' "Intelligence Instructions" of July 1918, machine gunners defending the line

should be in a position to furnish valuable data for Intelligence Reports. Machine Gun positions permanently manned will have an Intelligence Report kept by sentries which will primarily be concerned with movement in the enemy's lines. This report [is] to be handed over from sentry to sentry, and at the end of the period [which was not defined] checked by [the] N.C.O. in charge of [the] Machine Gun Post and collected by [the] Machine Gun Company H.Q. for transmission to [the] Infantry Brigade H.Q. to which [the] Machine Gun Company is affiliated.

From there any relevant information found its way into brigade and divisional

¹³ Currie, "Canadian Corps Operations," 232 - 240.

Intelligence Summaries.¹⁴

In a similar way, the effective use of trench mortar batteries required clear liaison channels. The July 1918 edition of the Canadian Corps "Intelligence Instructions" described how trench mortar intelligence and liaison worked. The trench mortar intelligence system resembled that of the Counter Battery Office, with each divisional trench mortar officer acting as the counter mortar officer for his front. He, aided by the divisional artillery reconnaissance officer, compiled intelligence on enemy trench mortars using records reminiscent of the Counter Battery Office. In the trench mortar control station, situated in the forward combat zone, an officer was always on duty. This centre had a direct telephone connection to the trench mortar observation post, and to flash spotting groups. It was also linked to artillery and infantry OPs, in the first case through artillery brigade arrangements, and in the second through artillery liaison officers working with the infantry. Since trench mortars worked from the forward lines, trench mortar officers had to maintain close touch with the infantry commands in the line. As with artillery counter battery work, locating an enemy mortar had to occur rapidly, for German mortars were more mobile than artillery, and did not necessarily remain long in one position after they fired.¹⁵ Figure 11.2, "Counter Mortar Intelligence," offers a graphic representation of these counter mortar intelligence arrangements.

As the artillery remained the decisive arm, liaison between it and the infantry remained crucial for battlefield success. In April, in order to deal with the increased speed of battle, Canadian Corps instructions explained that "The closest touch must

¹⁴ NAC, R.G. 24, Vol. 22,011. "Intelligence Instructions. Canadian Corps," July 1918; also R.G. 9 III C3, Vol. 4210, Folder 2, File 3. "Notes For The Information And Guidance Of All Officers Regarding The Organization of Machine Gun Battalions And Their Employment," Canadian Corps, April 30, 1918. A reconnaissance officer also served on the staff of the Canadian Machine Gun Corps, and handled the intelligence work for that organization.

¹⁵ NAC, R.G. 24, Vol. 22,011. "Intelligence Instructions. Canadian Corps," July 1918; Bill Rawling, *Surviving Trench Warfare, Technology and the Canadian Corps, 1914-1918* (Toronto: University of Toronto Press, 1992), 180-181.

Figure 11.2, Counter Mortar Intelligence

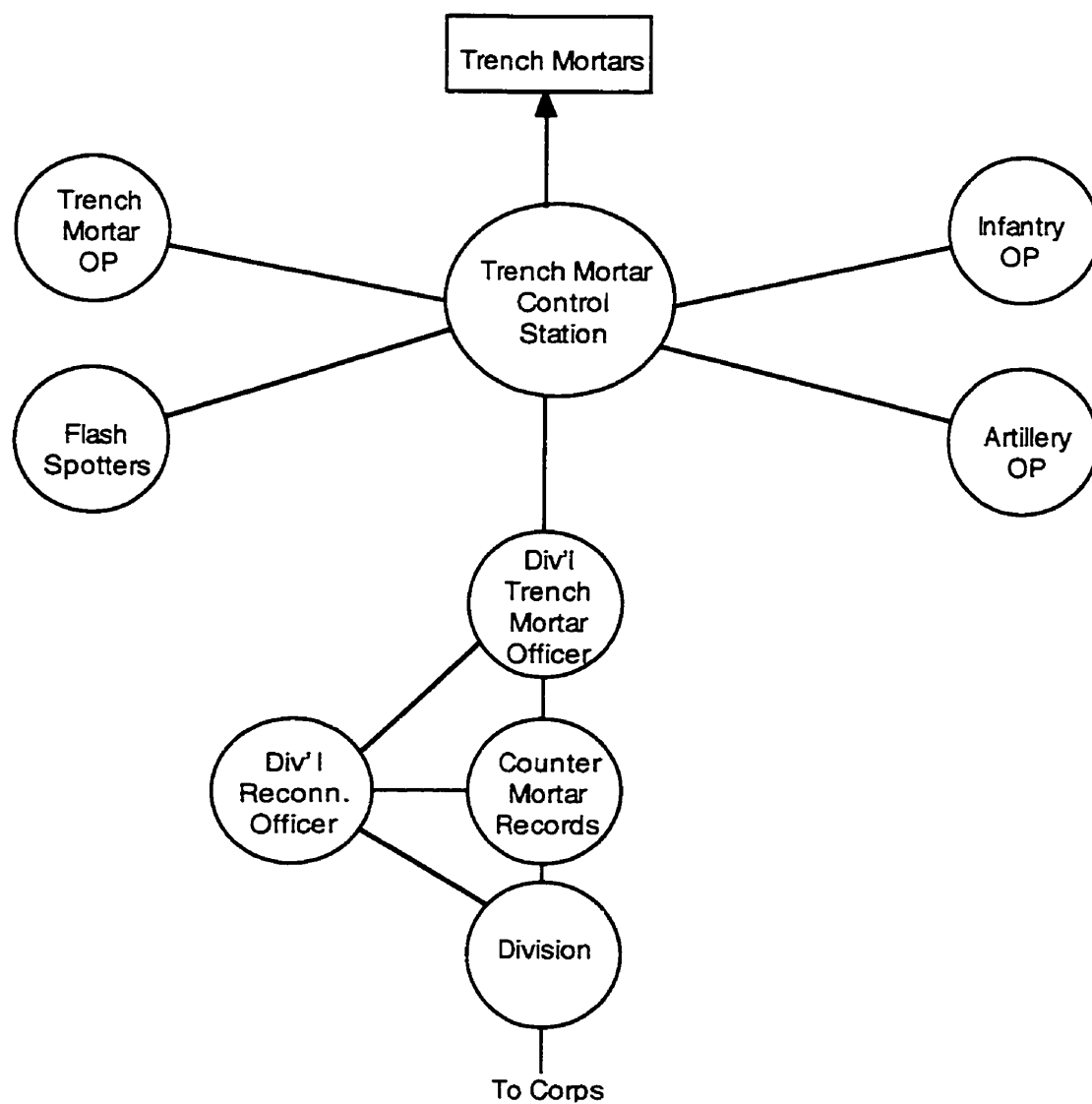

(Based on the description of counter mortar intelligence arrangements described in NAC, R.G. 24, Vol. 22,011. "Intelligence Instructions. Canadian Corps," July 1918).

be maintained between Infantry Brigadiers and the artillery acting in support of their commands.” The best way to ensure that touch was maintained was for the infantry and artillery brigade headquarters to locate near one another. When this was not possible, the artillery placed liaison officers with the infantry. The heavy artillery’s instructions for liaison officers explains this arrangement.

It is their [the liaison officers’] duty to obtain a full knowledge of the Infantry Brigade front so as to be able to give reliable information to their own Brigade, assist the G.O.C. Infantry Brigade in the selection of targets for the Heavy Artillery and advise the O.C. their own Brigade of the best means of Observation, arranging with Field Artillery Liaison Officers for the use of Field Artillery O.P.’s if targets can be best seen from them.

They will visit Battalion Headquarters frequently and should, when opportunity offers, on these occasions explain the organization and the tactical employment of the various natures of Heavy Artillery. Many misconceptions may in this way be removed, and a fuller interest and understanding engendered between the Infantry and Heavy Artillery.¹⁶

These same officers also worked closely with the field artillery LOs at the infantry brigade headquarters, thereby increasing the artillery’s overall effectiveness. In the same way, LOs placed with the infantry by the field artillery acted as information conduits, passing on to the gunners any information collected by the infantry, and to the infantry any gathered by the artillery. Helping to keep the artillery even more informed of the infantry situation were the artillery organized mounted officer patrols that went forward to “keep in touch with the infantry situation and the position of the enemy.”¹⁷

¹⁶ NAC, R.G. 24, Vol. 22,011. “Intelligence Instructions. Canadian Corps,” July 1918; R.G. 9 III C3, Vol. 4066, Folder 3, File 13. “Canadian Corps Heavy Artillery. Liaison Officers,” February 3, 1918.

¹⁷ NAC, R.G. 9 III C3, Vol. 4028, Folder 17, File 20. Canadian Corps to 1st, 3rd, and 4th Divisions, April 23, 1918. Mounted officers’ patrols seem to have been a new innovation for maintaining touch during open warfare. They went forward when FOOs and other ground observers lost touch with the action. See GHQ’s Training Leaflet No. 8, “Artillery Mounted Patrols With Infantry,” November 1918.

Communications were vital for liaison, and so they too were practiced by the Canadians. Mobile warfare did not lessen the need for telephones, so signallers rehearsed laying lines quickly. More importantly, by the summer of 1918, the Canadian Corps was making greater use of wireless. Back in January, field artillery observers began using wireless when registering their guns and reporting on information concerning the front. By July, wireless was used throughout the artillery down to at least artillery brigades. In the infantry, meanwhile, wireless sets were sometimes seen at company levels of command.¹⁸ Other signalling techniques were not neglected, however. Flags were important for infantry -- tank communication, with tanks displaying differently coloured flags to convey specific messages. Infantry scouts also rode in, or closely followed, each tank to watch the action and report to the tank commander any signals sent by the infantry. In the skies above, the RAF practiced contact patrol work with the infantry, the tanks and the artillery.

In addition to its tactical and signalling development, the corps made a number of organizational changes to improve efficiency. In March, divisional machine gun battalions were reorganized as divisional troops with their own commander. This allowed for greater centralized control over machine gun deployment and, therefore, greater coordination. Each machine gun battalion, moreover, had ninety-six Vickers guns compared to sixty-four in other British commands, giving the Canadians more striking-power. At the same time, Canadian divisions contained about 4,000 more men than other British divisions because of a British Army reorganization. This meant that Canadian divisions gained a "huge edge in offensive power as compared both to British and to German divisions."¹⁹

¹⁸ Rawling, *Surviving Trench Warfare*, 167 - 187; Kerry and McDill, *The History of the Corps of Royal Canadian Engineers: Vol. I, 1749 - 1939* (Ottawa: The Military Engineers Association of Canada, 1962), 248 - 251.

¹⁹ S.F. Wise to Author, May 25, 1999.

In May, Engineer Brigades were formed in each division in order that engineering work might be better controlled and organized. These brigades contained all the men necessary for doing the required engineering work, meaning the infantry no longer supplied the bulk of the labour force for work projects. This freed the men for fighting and training. With these changes the Canadians incorporated speed, hitting-power, and resiliency, into their corps' structure.²⁰

Other organizational and procedural improvements had a direct bearing on the efficiency of the intelligence system. The Canadian Corps Survey Section (CCSS), authorized in May 1918, was one such addition. It was formed in response to shortcomings in the collection of counter battery intelligence at Passchendaele.²¹ McNaughton, it will be recalled, accused the Field Survey Battalions of incompetence, and blamed them for the poor quality and quantity of counter battery intelligence collected during that operation. His complaint was that they did not keep pace with the advance, and were unresponsive to changing artillery needs as the assaults moved forward. What the Canadians "urgently

²⁰ John Swettenham, *To Seize the Victory, The Canadian Corps in World War I* (Toronto: The Ryerson Press, 1965), 204 - 205. Daniel Dancocks, *Sir Arthur Currie: A Biography* (Toronto: Methuen, 1985), 147 - 148; Rawling, *Surviving Trench Warfare*, 167 - 187; Currie, "Canadian Corps Operations," 103; A.M.J. Hyatt, *General Sir Arthur Currie, A Military Biography* (Toronto: University of Toronto Press, 1987), 110 - 113.

²¹ Actually, the roots of the CCSS goes back at least to the summer of 1917. At that time Major W.R. Bertram, the GSO2(I) at corps, desired some corps-level means of observing the country in the rear of the enemy's position other than relying on the eyes of those not under his direct control. To meet some of this need, Bertram asked Lieutenant W.R. Flewin, the officer directing the corps' Topographical Section (mainly responsible for surveys and map production), to prepare a corps-level OP on Vimy Ridge. The OP opened for business on July twenty-fourth, and employed ten men, mainly seconded from the Canadian Light Horse. The post remained in operation for three months, and was very active during the preparations for the Canadian assault on Hill 70. When the corps moved to Passchendaele in the autumn of 1917, a similar corps OP was instituted there, employing twenty-three observers. Continuous observation was maintained from this OP throughout the Canadians' tour at Passchendaele, despite the loss of several men killed. See NAC, R.G. 9 III D1, Vol. 4711, Folder 98, File 9. "History of the Canadian Corps Survey Section," by Captain W.R. Flewin, April 1919.

required,” he thought, was “a mobile section” under artillery control that could quickly “exploit newly gained observing localities.”²² Such an organization would help keep the gunners in-tune with the situation at the front.

Soon after the Passchendaele fighting ended, then, McNaughton teamed up with Lieutenant W.R. Flewin, head of the corps Topographical Section, and Lieutenant Colonel W.R. Bertram, the corps’ GSO2(I), to discuss ways of improving counter battery and corps level intelligence collection. The solution these men proposed was the creation of an organization that embraced the Topographical Section, the corps-level observers, and teams of flash spotters and sound rangers.²³ The resultant Canadian Corps Survey Section was divided into three sections: a headquarters section, an artillery observation section, and an intelligence observation section.²⁴ The headquarters section collected and coordinated information gathered by the other two sections. It also handled the tasks of the old Topographical Section and was therefore responsible for the corps’ specialty map production and distribution. A subsection of the headquarters section also surveyed friendly battery positions and prepared battery boards for gunners.²⁵ This later task

²² NAC, R.G. 9 III C1, Vol. 3922, Folder 7, File 6. Counter Battery Office to Canadian Corps intelligence, February 6, 1918.

²³ NAC, R.G. 9 III D1, Vol. 4711, Folder 98, File 9. “History of the Canadian Corps Survey Section,” by Captain Flewin, April 1919.

²⁴ The CCSS employed 177 all ranks, not including drivers. The men employed in the CCSS were seconded from all services and, except for the flash spotters, most were already trained for their tasks. The training of flash spotters was carried out by men from the 1st British Field Survey Battalion. Flewin, now a captain, was placed in command, and he remained in that position for the remainder of the war.

²⁵ Battery boards, or artillery boards, were special maps used by the artillery for taking bearings on enemy positions. Each battery had its own map. The problem with paper maps, however, was that they shrank or expanded due to atmospheric conditions, and this caused errors in bearings. As Lieutenant Colonel H.S.L. Winterbotham, who some considered the father of the Survey Battalions, explained, the paper errors could be “eliminated by supplying zinc boards on which the map is pasted bit by bit into its correct position. The board is covered with a grid of squares which is plotted on the zinc. The map is now cut up into squares which are pasted down into the correct positions. Upon this ‘artillery board’ the trigonometrically fixed positions [of friendly batteries and enemy targets] can now be plotted, and ranges and bearings to trench junctions, etc., can be more accurately measured. An arc divided to 10’, or reading to 2’ by estimation, is pasted on the

was crucial to gunners using predicted fire, as battery boards accurately plotted the location of both friendly and hostile batteries. (The enormity of this task is apparent when one realizes that each battery -- friendly and enemy -- had to be surveyed, and a unique battery board prepared for each battery). In addition, the headquarters unit worked closely with the branch intelligence officer stationed with the corps squadron to smooth the transfer of aerial and photographic intelligence.

The artillery observation section, for its part, was composed of three teams of flash spotters whose task was to locate enemy batteries, and to range friendly guns. Sound rangers were not included in the final CCSS establishment, likely because sound rangers, due to the nature of their equipment, were not particularly mobile. The flash spotting teams, however, did not locate enemy batteries to the same degree of accuracy as the army sections did during stationary warfare, but corps headquarters felt that rough approximations secured quickly while on the march were better than no locations at all.²⁶ As such, CCSS flash spotters were not expected to replace army observation sections whose findings the Canadians still used. Information provided by the CCSS flash spotters simply supplemented that supplied by the army.

Meanwhile, the intelligence observation section watched enemy activity in and behind the German front. The intelligence observation section usually comprised three observation posts, each manned by trained scout observers. These corps OPs were not fixed posts, but were instead "mobile units...prepared to follow the Infantry advance closely and to exploit the opportunities of observation which are obtained by this advance with the least possible delay." For this purpose

board with the gun position as centre." See H.S.L. Winterbotham, "British Survey on the Western Front, *The Geographical Journal* 53.4 (April 1919), 256 - 257; also NAC, M.G. 30 E61 (Mitchell Papers) Vol. 34, Folder: Italian and Eastern Fronts, Orders and Instructions, Instructions: "Maps and Artillery Boards," second edition, January 1918.

²⁶ NAC, R.G. 9 III C1, Vol. 3920, Folder 2, File 2. Counter Battery Office to War Narrative Section, Canadian Corps, February 3, 1919.

they had the use of wireless sets, as well as other communications apparatus.²⁷ With this organization the corps believed it was in a better position to respond to changing conditions at the front, as the CCSS gave corps headquarters its own ground-level 'telescope' to the forward lines. Since the CCSS was stocked with wireless equipment and other signalling apparatus, any information it collected quickly reached those in need of it -- a vital consideration in fast paced, changing environments. Other British corps began forming corps observation teams, or scout groups, in 1918 as well. The CCSS differed from these in that the CCSS controlled its own corps-level flash spotters. Other British corps continued to rely fully on army controlled flash spotters. This made the CCSS unique in the British Army. As the CCSS was under the counter battery staff officer's tactical control, McNaughton's desire for an artillery sensitive intelligence gathering body was fulfilled; or as one report stated: "The C.C.S.S., therefore, was intended to combine as much as possible of the accuracy attained by the Army Observation Groups during trench warfare and the general intelligence work of the Lovat Scouts [i.e. corps observers], with the mobility required for open warfare."²⁸ With the CCSS the Canadian Corps was, once again, trying to build mobility and speed into its organization, this time as it concerned intelligence collection and use.

In keeping with the need for increased efficiency, 1918 saw the corps formalize the establishments of its battalion and brigade intelligence sections. The November 1917 "Notes on Training" argued that "No lesson has been more

²⁷ NAC, R.G. 9 III C1, Vol. 3922, Folder 7, File 6. Counter Battery Office to corps intelligence, August 18, 1918; R.G. 9 III D1, Vol. 4711, Folder 98, File 9. "History of the Canadian Corps Survey Section," by Captain Flewin, April 1919; R.G. 9 III B1, Vol. 967, File 0-4-3, Vol. 2. Canadian Corps Survey Section to Corps, August 2, 1918, and December 19, 1918; R.G. 9 III C1, Vol. 3920, Folder 2, File 2. Counter Battery Office to War Narrative Section, Canadian Corps, February 3, 1919.

²⁸ NAC, R.G. 9 III C1, Vol. 3920, Folder 2, File 2. Counter Battery Office to War Narrative Section, Canadian Corps, February 3, 1919.

st[r]ikingly exemplified in the recent operations than the necessity of [an] efficient Intelligence organization or the disasters [sic] that attend any neglect in this respect.” This was a powerful endorsement. The ‘Notes’ went on to say that good intelligence had

its foundation in the Front Line, i.e., in the Intelligence Sections of the Battalions, which by means of their trained Observers and Scouts, combining the results of active patrolling with that of reconnaissance from well-selected O.Ps., provide the detailed information as to the enemy’s defensive organization, wire, and general dispositions, on which the plan of attack must be worked out.²⁹

As the foundation of intelligence work was in the front line, this is where the most significant changes occurred. At the battalion level of command a second officer and a number of clerks were added to intelligence sections. This change institutionalized what a number of battalions had been practicing since the end of 1916. Since that time many battalions employed an extra officer on intelligence work as a kind-of understudy to the scout officer.³⁰ In January 1918, the corps announced that the two officer arrangement was the desired practice, and in March the corps laid down the new establishment, and called for the following personnel: one battalion intelligence officer, one scout officer, one scout corporal, sixteen scouts (eight specially trained in observation), eight snipers, and one photographic clerk who doubled as the units’ draftsman. Companies and platoons, of course, continued to employ their own scouts and snipers.

²⁹ NAC, R.G. 9 III C3, Vol. 4064, Folder 15, File 6. “Canadian Corps Notes on Training,” issued November 27, 1917.

³⁰ The Canadian Corps began encouraging this practice at least as early as December 1916. See R.G. 9 III C4, Vol. 4246, Folder 10, File 2. Canadian Corps to 2nd Division, December 16, 1916. In January 1918, the various divisions announced the change more formally. See Vol. 4188, Folder 4, File 4. 3rd Division to subordinates and corps, January 30, 1918; and Vol. 4044, Folder 4, File 4. 4th Battalion to 1st Brigade, January 16, 1918.

The duties of both officers were clearly demarcated. Battalion intelligence officers were responsible for distributing intelligence and maps throughout the battalion, and for compiling battalion intelligence reports.³¹ Furthermore, it was their job to ensure that battalion OPs were properly situated and coordinated with those of neighbouring battalions and companies, and that trench log maps were maintained. They had to be fully acquainted with all aspects of battalion intelligence and sniping work, and be well versed in the causes of inaccuracy and defects in rifles, telescopic sights, telescopes and field glasses. Their job also required a proficiency in the construction of observation posts, sniper posts, and loopholes, and a working knowledge of field sketching, report writing, map and photographic interpretation, compass work, camouflaging, relief procedures, and the corps' intelligence organization. Meanwhile, scout officers assisted the intelligence officers. However, their principal concern lay with the collection of information on no man's land. They did this by arranging nightly patrols and continuous observation, and by working closely with company commanders and scout officers in neighbouring battalions. Scout officers also arranged special patrols deemed necessary by their battalion commanders. When out of the line it was their job to train the scouts and snipers.³²

³¹ NAC, R.G. 9 III C3, Vol. 4025, Folder 7, File 5. First Division to 1st Brigade, January 10, 1918.

³² NAC, R.G. 9 III C1, Vol. 3872, Folder 117, File 3. Canadian Corps memorandum January 30, 1918; R.G. 9 III C3, Vol. 4187, Folder 4, File 1. "Intelligence Instructions," Canadian Corps, March 3, 1918; and R.G. 24, Vol. 22,011. "Intelligence Instructions. Canadian Corps," July 1918; M.G. 30 E100 (Currie Papers) Vol. 37, File 165. "Intelligence Organization 4th Canadian Division," January 22, 1918; J.E. Hahn, *The Intelligence Service Within the Canadian Corps, 1914-1918* (Toronto: The Macmillan Company of Canada, Limited, 1930), 69-71. The battalion intelligence section was still an unofficial establishment; for example, the 2nd Division wrote: "When the necessary additions have been made the following establishment (unauthorized) will be..." See R.G. 9 III C3, Vol. 4130, Folder 8, File 1. 2nd Division notice, February 22, 1918.

Brigade and divisional intelligence organizations were left largely untouched. In each brigade, therefore, there was a staff captain(I), twelve observers, one photographic clerk, two draftsmen, and one office clerk.³³ At division there was a GSO2(I), a GSO3(I), and one Intelligence Corps officer attached from the British Intelligence Corps, along with three draftsmen, an air photographic clerk, and two other clerks.³⁴ Divisional observers were still employed on a temporary basis.

These establishments, of course, represented the ideal. In reality there were difficulties to overcome. Equipment shortages were common, with intelligence sections still having to borrow telescopes from the signal organization. If equipment was damaged by shell fire or through some other means, wrote the 1st Brigade, "considerable difficulty and loss of time is experienced in having the articles replaced." Furthermore, the equipment scarcity injured unit efficiency and morale; the 1st Brigade stated that up-to-date equipment, should it receive any, "would act as an incentive to greater efforts on the part of the observers in obtaining more reliable information, and consequently better results."³⁵ General Currie echoed this sentiment after the war when he wrote that "a definite and comprehensive establishment for Intelligence equipment was wanting, much of the material being improvised in the field, and varying in quantity and quality."³⁶ Another problem was in finding officers and men with the requisite experience and understanding of intelligence work to take on battalion intelligence duties. The

³³ NAC, R.G. 9 III C3., Vol. 4187, Folder 4, File 1. "Intelligence Instructions," Canadian Corps, March 3, 1918; and R.G. 24, Vol. 22,011. "Intelligence Instructions. Canadian Corps," July 1918.

³⁴ S.R. Elliot, *Scarlet to Green. A History of Intelligence in the Canadian Army 1903 - 1963* (Toronto: Canadian Intelligence and Security Association, 1981), 38.

³⁵ NAC, R.G. 9 Vol. 4025, Folder 7, File 4. 1st Brigade to 1st Division, March 19, 1918; also Folder 5. 1st Division to 1st Brigade, January 10, 1918.

³⁶ Arthur Currie "Historical Resume of Canadian Corps Intelligence," in J.E. Hahn's, *The Intelligence Service Within the Canadian Corps 1914-1918* (Toronto: The Macmillan Company of Canada, Limited, 1930), xxii.

shortage of trained officers meant some battalions continued to employ only one officer rather than the two called for. The 72nd Battalion complained in a letter to the 12th Brigade in January 1918 that “while we have one or two men who have had lectures on this [photographic interpretation] our low strength prevents our having a special man for this work, which is done by the Battalion Intelligence Officer. Our low strength also does not allow the use of a draughtsman.”³⁷ The 116th Battalion reported in October that it did not have a scout officer, so the intelligence officer handled the scouting duties in addition to his own. It also said that its intelligence section had been reduced to six observers, one sniper, and no scouts.³⁸ At other times, officers without the necessary training were thrust into the role of intelligence officer simply because there was a shortage of trained personnel, either due to casualties, illness, temporary leaves of absence, or transfers.³⁹ The 1st Brigade reported in October that approximately twenty-five percent of its battalions’ intelligence sections were untrained, but that a special training course was being set up for battalion intelligence officers to train the new men.⁴⁰

While they searched for equipment, intelligence sections rehearsed their battlefield roles. Tactical exercises carried out in the summer of 1918 brought home the idea that trench and open fighting would follow one another in a series, and that proficiency in both was necessary. Lessons learned during trench warfare were often valuable in open warfare. “Take for instance reconnaissance,” observed the corps’ ‘Notes on Training,’ “The correct procedure has been forced on us by trench warfare, in which the Observer makes his way unseen to the best possible point

³⁷ NAC, R.G. 9 III C3, Vol. 4224, Folder 6, File 13. 72nd Battalion to the 12th Brigade, January 15, 1918.

³⁸ NAC, R.G. 9 III C3, Vol. 4188, Folder 4, File 4. 116th Battalion to 9th Brigade, October 6, 1918.

³⁹ NAC, R.G. 24, Vol. 22,010. “Canadian Handbook for Scouts, Observers, and Snipers,” by Major N.A.D. Armstrong, April 1918.

⁴⁰ NAC, R.G. 9 III C3, Vol. 4025, Folder 7, File 4. Nominal roll for intelligence personnel, 1st Brigade, October 25, 1918; 1st Brigade to 1st Division regarding an intelligence officers’ meeting, October 25, 1918.

from which to see, and remains hidden in the O.P. while making his reconnaissance with the aid of a telescope." In open warfare the same principles applied. One of the tactical schemes outlined in the April 1918 "Canadian Handbook for Scouts, Observers, and Snipers" emphasized the need for quick reconnaissance of new enemy positions once the enemy was driven out of their forward line and into prepared defences further back. A second scheme saw the scouts trying to keep in contact with, and report on the location of, a rapidly retreating enemy. A third scheme practiced battalion intelligence sections in their role during an attack. With this scheme, scouts had to quickly regain touch with the retreating enemy, while observers further back monitored the action. At the same time, scouts and observers practiced relaying news to battalion and company headquarters in their rear.⁴¹ Scouts also rehearsed the basics: map reading, sketching, message and report writing, and patrolling.⁴² Moreover, close liaison between intelligence sections and the artillery had long been "an essential part of the organization," and this did not change with the advent of open warfare. As well, it was crucial that staff officers from the three General Staff branches: Intelligence, Training, and Operations, understand the work and needs of the other. "No Officer in one Branch can do his work properly if he is not in close touch with the work of the others," wrote the corps. Intelligence staff officers, for example, "cannot correctly appreciate the meaning of the information which comes to hand and deduce from it anything really constructive or of practical value unless he has a thorough knowledge of operations and is familiar with the latest ideas on Infantry and Artillery methods of fighting."⁴³

⁴¹ NAC, R.G. 24, Vol. 22,010. "Canadian Handbook for Scouts, Observes, and Snipers," by Major N.A.D. Armstrong, April 1918.

⁴² NAC, R.G. 9 III C3, Vol. 4095, Folder 36, File 3. 4th Brigade's "Training and Employment of Battalion and Company Scouts, Etc.," November 29, 1917.

⁴³ NAC, R.G. 9 III C3, Vol. 4064, Folder 15, File 6. "Canadian Corps Notes on Training," issued November 27, 1917.

In the meantime, in March, the Canadian Corps released its "Intelligence Instructions." This was an important document in the corps' intelligence development. Prior to these instructions the corps' intelligence policy was a patchwork of British instructions, and Canadian Corps guidelines and memorandums that dealt with specific intelligence issues.⁴⁴ The goal of the Canadian Corps "Intelligence Instructions" was to bring under one cover these various instructions, and "to obtain uniformity of method in General Staff (Intelligence) work throughout the Corps, and at the same time to ensure that the best use is being made of information." In doing this, the "Intelligence Instructions" described the variety and use of the various intelligence records necessary, and discussed the issuance and use of airplane photographs, trench mortar intelligence, espionage, and the need for cooperation between the various service arms. It also restated the duties of various intelligence officers, and outlined the proper procedures to be followed, and documents to be handed over, during a relief for all levels of command, down to batteries and OPs. And as we have seen, it standardized the intelligence sections working throughout the corps.⁴⁵ In July 1918, the March edition of the Canadian Corps "Intelligence Instructions" expanded into a more formal booklet version with new sections added to cover the role of divisional artillery reconnaissance officers, sound ranging and flash spotting and, as a reflection of the importance of counter battery fire to winning the war, a section on how counter battery intelligence worked within the Canadian Corps.⁴⁶ Significantly, this latter section occupied fully one third of the twenty-four page booklet.

⁴⁴ From at least the summer of 1916, however, divisions had been compiling their own divisional instructions, giving those commands uniformity in their intelligence organization.

⁴⁵ NAC, R.G. 9 III C3, Vol. 4187, Folder 4, File 1. "Intelligence Instructions," Canadian Corps, March 3, 1918. NAC, R.G. 24, Vol. 22,011. "Intelligence Instructions. Canadian Corps," July 1918.

⁴⁶ NAC, R.G. 24, Vol. 22,011. "Intelligence Instructions. Canadian Corps," July 1918.

Apart from its content, the Canadian Corps' "Intelligence Instructions" announced the emergence of a Canadian intelligence policy, and a willingness to break out from under the British intelligence umbrella -- an umbrella that had done so much to nurture the Canadian Corps' own intelligence system. The "Intelligence Instructions" reflected the fact that the corps had transformed into a *Canadian Corps*. The renown the corps had won for Canada through the battles of 1917, changed the CEF and Canada from the naive, submissive colonials of 1914, into a self-proclaimed ally who felt its opinions should be heard in areas affecting the operation of the corps. This search for voice played itself out both politically and militarily and, obviously, even had consequences for the intelligence service. This same sense of confidence and independence was in evidence when the Canadians released their "Canadian Handbook for Scouts, Observers, and Snipers" in April 1918. Significantly, this handbook was produced about four months after GHQ released its own guidebook called "Scouting and Patrolling" (S.S. 195). These two guides covered many of the same topics, but the "Canadian Handbook for Scouts, Observers, and Snipers," as with the Canadian Corps "Intelligence Instructions," reflected Canadian practices and hard earned knowledge and experiences.⁴⁷

Perhaps the corps' most obvious display of independence regarding intelligence matters was its quest for a Canadian Intelligence Corps. Since early in the war the Canadian Corps had attached to it officers from the British Intelligence Corps; officers who were not necessarily Canadians or from Canadian units. Around July 1918, however, Currie asked that this practice be reversed, as he wanted all Intelligence Corps officers attached to the Canadian Corps be drawn from Canadian units. The British tried to accommodate, and according to the commandant of the British Intelligence Corps, every effort to train Canadian

⁴⁷ NAC, R.G. 24, Vol. 22,010. "Canadian Handbook for Scouts, Observers, and Snipers," compiled by Major N.A.D. Armstrong, April 1918.

officers as intelligence officers would be taken at the Intelligence School at Harrow.⁴⁸ The problem with this proposal, however, was that for Canadians to serve as Intelligence Corps officers attached to the Canadian Corps they first had to be seconded to the British Intelligence Corps and then reattached to the Canadians. But, as Currie stated, "Not only has this caused considerable confusion, but it is not in accordance with the general policy of the Canadian authorities." Instead, after reevaluating the situation, Currie proposed the creation of a Canadian Intelligence Corps. In September he wrote that "the time has come when all Intelligence appointments in the Canadian Corps should gradually be filled by Canadians," and the British officers then employed by the corps be returned to British formations. This meant "that...the Intelligence Establishment now existing [should] be taken over as a Canadian Establishment," and that a Canadian Intelligence Corps be opened and operated in France. It was Currie's intention that this new organization encompass the Branch Intelligence Section attached to the corps squadron, and the Intelligence Police organization operating in the corps area.⁴⁹ By mid October a decision by higher authorities had yet to be reached on his proposal, not because of British intransigence, but for the simple fact that it took time to work out all the details.⁵⁰ Nevertheless, the slow pace of decision was not to Currie's liking, which he made clear in a letter to the Canadian Section at GHQ. He wrote: "As the delay in this matter has already been almost five weeks I would ask that it may now be expedited and that I may be advised what action has been taken."⁵¹ It was only on November first, however, that the War Office finally

⁴⁸ NAC, R. G. 9 III C1, Vol. 3872, Folder 117, File 3. Intelligence Corps commandant to Officer Commanding 1st Intelligence Corps Company, July 13, 1918.

⁴⁹ NAC, R.G. 9 III C1, Vol. 3872, Folder 117, File 4. Currie to Canadian Section, GHQ, September 9, 1918. Also R.G. 9 III B1, Vol. 943, Folder E-126-3. Currie to 1st Army, July 11, 1918.

⁵⁰ See correspondence in NAC, R.G. 9 III B1, Vol. 943, Folder: E-126-3.

⁵¹ NAC, R.G. 9 III B1, Vol. 943, Folder: E-126-3. Currie to GOC, Canadian Section GHQ, October 14, 1918.

approved the creation of a Canadian Intelligence Corps Section, but it was not until the guns had long stopped firing, March 5, 1919, that the Minister for the Overseas Military Forces of Canada gave his stamp of approval, dating the existence of the Canadian Intelligence Corps (France) from October 14, 1918.⁵² Table 11.1: "Canadian Intelligence Corps (France)," shows the approved establishment.

The Canadian Corps and its intelligence organization reached maturity in 1918. As Desmond Morton has shown, the war had transformed the way Canadians thought about themselves, their country and their military contribution. Unlike the early years of the war, the Canadians in 1918 were acting as 'junior but sovereign allies,' not colonials.⁵³ General Currie's Canadianization of the corps was just one manifestation of this process. Meanwhile, as the Canadians searched for their identity they continued their quest for victory. In the process they advanced a style of fighting capable of defeating even the most powerful German defences -- a system that demanded high quality intelligence in addition to effective tactics. To meet the new intelligence needs, the Canadians revised some of their intelligence procedures and expanded others. In the process the improved intelligence service helped restore command and control functions to commanders in the field, particularly at corps and divisional levels. The use of report centres for shortening the distance that news had to travel, the continued use of airplane contact patrols for recovering information on the front line situation, and the development of the CCSS for quick collection of information from the front all, to a degree, helped free commanders from rigid time-table tactics by supplying them with a continuous stream of up to the minute news on events at the front. This let corps

⁵² NAC, R.G. 9 III B1, Vol. 943, Vol. E-126-3. Adjutant General, Military Forces of Canada, to the Secretary, War Office, March 5, 1919.

⁵³ Desmond Morton, "'Junior But Sovereign Allies: The Transformation of the Canadian Expeditionary Force, 1914 - 1918,'" *Journal of Imperial & Commonwealth History* 8.1 (October 1979), 56 - 67.

Table 11.1: Canadian Intelligence Corps (France)⁵⁴

Details	Officers	Staff Sgts.	Sgts.	Clerks	Pvts	Cycles	Motor-Cycles
Canadian Corps HQ:							
Intelligence (A)	1 note a						
Intelligence (A)	2 note b						
Intelligence (B)	1	1 note c	1 note c		10 note c	10	
Intelligence (E)	1 note d			2 note f			
Corps Squadron	2 note e						
Four Divisions	4 note e						
Batmen					11		
Motor-cycles							11

Notes:

- a. Graded for pay as staff captain.
- b. Subalterns. One graded for pay as staff lieutenant, first grade.
- c. Paid as clerks.
- d. Attached to army HQ to augment army staff, especially for work regarding the Canadian Corps front.
- e. Graded for pay as staff lieutenants, first grade.
- f. Includes a sergeant.

g. Intelligence (A) = operational intelligence

h. Intelligence (B) = counter espionage

i. Intelligence (E) = Wireless intelligence

⁵⁴ NAC, R.G. 9 III B1, Vol. 943, Vol. E-126-3. Adjutant General, Military Forces of Canada, to the Secretary, War Office, March 5, 1919.

and divisional commanders, along with their formations' artillery commanders, intervene in the action in ways impossible earlier in the war, when word from the front might take hours to arrive at these headquarters. Along with information received from other sources (artillery OPs and FOOs, for example), intelligence gave commanders quick insight into developments at the front, and helped them switch from trench warfare where "we do things 'by numbers'" to a more open style of fighting where "we have to do the same things in 'quick time.'"⁵⁵ With open warfare, however, the intelligence organization could not collect every scrap of information on the enemy lines the way it could during the trench deadlock, which meant unforeseen obstacles were bound to arise as troops made for their pre-assigned objectives. When this occurred, the small unit tactics then being practiced kicked in to deal with the situation as presented, while close liaison helped keep supporting arms in touch with the infantry's immediate needs. In short, the Canadians believed that small unit tactics working in conjunction with thorough plans and a flexible command arrangement reduced confusion, and granted them more liberty to seize opportunities, and switch from trench fighting to manoeuvre warfare fairly readily. Their next operation would determine if their training was in vain.

⁵⁵ NAC, M.G. 30 E60 (Matthews Papers) Vol. 4, Folder: Training 1917. "Canadian Corps Notes on Training, November 1917."

CHAPTER TWELVE

THE 100 DAYS: AUGUST 8 TO NOVEMBER 11, 1918

From the Battle of Amiens through to the Armistice, the Canadian Corps spearheaded the final British drive that saw the defeat of Germany. Victory followed victory as the corps made its way from Amiens, to the Scarpe, through the Drocourt-Quéant Line (D-Q Line), over the Canal du Nord, through Cambrai, over Mount Houy into Valenciennes, and ending with the capture of Mons.¹ It was a period of high intensity conflict, and one that saw the Canadians launch a series of rapid blows against some of the toughest defensive positions they had yet faced. Set-piece assaults, found so effective in the past for defeating strong enemy defences, continued to be used by the Canadians throughout the 100 Days. However, during the final four months of the war, battles followed one another so quickly that the Canadians no longer had the luxury of time when compiling and preparing their plans, so intelligence gathering and offensive planning had to occur at a far faster pace than previously. The intelligence organization, having become accustomed to a more leisurely and methodical tempo, had to switch gears and work in quick time. It was more than just the time factor that affected intelligence operations, though, as the depth of planned advances also had an impact. During the 100 Days the corps regularly planned to penetrate several kilometers into German held positions before consolidating their gains, unlike its assaults at Vimy

¹ The Battle of the Scarpe began on August twenty-sixth; the D-Q Line started on September second; the Canal du Nord on September twenty-seventh; Cambrai started on October eighth; Mount Houy/Valenciennes was taken on November first, and Mons on the eleventh.

Ridge, Hill 70, and Passchendaele in 1917, where comparatively shallow objectives were sought. Deeper penetrations, and a dearth of planning time, meant that more German defences (hidden machine guns, trench mortars and dugouts, for example) went undetected and undestroyed prior to infantry assaults. But unlike earlier in the war when an undisclosed machine gun could halt an entire advance and cause considerable pandemonium, during the 100 Days the Canadians fully expected to encounter unknown obstacles. Their tactical training, however, taught them to accept disruptions to their plans as a natural part of battle, while their tactical skill and intelligence gathering abilities helped them persevere.

The intelligence system, then, remained crucial to operations during the victorious 100 Days campaign. As the November 1918 edition of GHQ's "Instructions for the Training of Divisions for Offensive Action" (S.S. 135) states: "It must be remembered that on intelligence will depend, to a large degree, the successful and thorough artillery, tank, and machine gun work which is such a large factor in obtaining success combined with a small casualty list."² Since the waging of set-piece attacks, with their detailed planning and need for massive quantities of high quality intelligence, continued as normal Canadian practice, intelligence work remained a top priority for each Canadian assault. Plans were still as detailed as possible, especially the artillery programs, but with the more fluid battles expected in 1918, intelligence gatherers had to collect and transmit far more information during the advance than before. This was because intelligence gatherers had to help keep the supporting arms that were advancing with the infantry fully in-tune with events in order that they could quickly come into action where and when required. More and more of the important decisions, in other words, were being made in the heat of battle, and by junior officers commanding

² National Archives of Canada (NAC), Record Group (R.G.) 24, Vol. 22,007, Folder: The Division in the Attack. S.S. 135, November 1918 edition.

smaller and smaller units. Such decentralized decision-making demanded the rapid collection of accurate intelligence and a flexible communications system to carry it. Back in 1915, such a reliance on small unit initiative would have invited disaster, but by 1918, the men were able to move forward, and their aggressiveness helped send the German Army reeling backwards.

By July 1918, it was clear to most observers that the German Peace Offensive had failed; it was now the Allies' turn to attack. The Canadian Corps, having been spared the worst of the German spring onslaught, was up to strength, well trained, and ready to lead the next British offensive. That trial came on August eighth with the opening of the Battle of Amiens; a battle that Major-General J.F.C. Fuller called the most decisive battle of the war. The Allied victory at Amiens set the German Army on the road to defeat.³

The City of Amiens was an important rail and communications centre. It was almost lost to the Germans earlier in the year when their spring offensive was at its peak. German troops only a few miles away remained a threat to the city, though, and to relieve the pressure the British and French armies planned a joint operation to push them back. The 4th British Army, employing the 3rd British Corps on its left, the Australian Corps in the centre, and the recently arrived Canadian Corps on the right, carried out the British part of the operation. Operating on the right of the Canadian Corps was the 31st French Corps. The objective of the assault was the old Amiens outer defence line lying some eight miles from the Allied front. Despite Field Marshal Sir Douglas Haig's call for a breakthrough and an open-ended assault, the attack largely remained a limited offensive set-piece style assault, the type of assault at which the Canadians excelled.

³ J.F.C. Fuller, *A Military History of the Western World, Vol. III, From the American Civil War to the End of World War II* (1957; reprint, New York: Da Capo Press, Inc., no date), 276.

Unlike most previous battles, surprise was a key factor in the Allied plans at Amiens. But as past experience had shown, this could be difficult to achieve in practice. Surprise was especially hard to secure at Amiens because the Canadian Corps had to leave the 1st Army's sector, move fifty to sixty miles south, and reenter the lines in the 4th Army's sector alongside the Australians without the Germans detecting their presence. Any hint that the Canadians were alongside the Australians would guarantee the loss of surprise, for the Germans considered both formations to be storm troops. Their appearance together would have been all the warning necessary for the Germans to strengthen their defences, and be on alert.⁴

Secrecy, then, played an important part in achieving the necessary surprise. Officers and commanders only learned of the proposed operation on a need to know basis. General Currie and his senior staff officer, Brigadier General N.W. Webber, learned of the Amiens plan on July twentieth, for example, but it was three more days before Currie informed Major-General Morrison, the commander the corps artillery, and Lieutenant Colonel McNaughton, the CBSO. Letting the artillery in on the secret before the infantry was a reflection of just how important the artillery's contribution to battle had become. These were the only officers in the corps to know of the plan until the end of July, and they began to plan accordingly. On the twenty-ninth, Currie let his divisional commanders in on the secret, and the next day the corps began its clandestine move to the Amiens sector, with the bulk of the troops arriving in the rear areas by the night of August 3/4, 1918, where their movements were severely restricted during daylight hours, and only select officers let in on the secret. The 2nd Divisional Artillery noted, for example, that "No information [on the impending operation] was given to anyone except the Senior Officers, whose duty it was to go forward and reconnoitre battery positions. This

⁴ B.H. Liddell Hart, *History of the First World War*, (London: Papermac, 1970; reprint of *The Real War, 1914 - 1918*, Faber and Faber Ltd., 1930), 428.

was done during the stage that the Divisional Artillery was on the march” to the Amiens sector.⁵ Divisional staff officers also went forward to reconnoitre the ground and to collect “all available topographical information...together with maps and oblique photos.”⁶ Meanwhile, brigade commanders learned of the impending assault only on August first. Battalion commanders, on the other hand, remained in the dark until some thirty-six hours prior to their units’ going over the top. Even then, reconnaissance was severely restricted, with reconnaissance parties limited to no more than two people, and then only carried out when it was essential, and only if it was done “as inconspicuously as possible.”⁷ High ground and OPs were off limits, and officers were not to show their maps in the forward area, as officers with maps in hand were dead give-aways that something was afoot.⁸

At the same time, a grand deception, at least by World War One standards, went into operation in an effort to confuse the Germans as to the real location of the Canadian Corps. Canadian Corps medical units moved north to Flanders, with Currie knowing full well that German spies would detect them, and report that the Canadians were headed for the Ypres Sector. As McNaughton said: “If you move a hospital and all those pretty nurses, you can be sure that in the eyes of the Germans the boys follow the girls so that’s where the Corps was going.” This

⁵ NAC, R.G. 9 III C1, Vol. 3923, Folder 10, File 5. “Attack By Canadian Corps, August 8th., 1918, 2nd. Canadian Divisional Artillery, Report on Operations,” August 22, 1918.

⁶ NAC, M.G. 30 E6 (Burstall Papers) Vol. 3, Folder 21. “2nd Canadian Division Narrative of Operations From March 13th to Nov. 11th 1918.” I did not learn how many days in advance of the main body these staff officers arrived in the Amiens sector to begin compiling information. They could not have been there very long, however, considering the assault was launched just one week after the divisions were informed of the plans. It also seems likely that the staff officers who went forward to collect information included divisional intelligence officers, although I did not find any definite proof of this.

⁷ NAC, Manuscript Group (M.G.) 30 E6 (Burstall Papers) Vol. 1, Folder 1. 2nd Canadian Division Operation Order No. 222, August 5, 1918.

⁸ NAC, R.G. 9 III C3, Vol. 4163, Folder 11, File 4. 7th Brigade’s “Instructions for Offensive No. 1,” August 5, 1918. Other brigade’s gave similar orders. See 9th Brigade in same folder.

move also helped confuse the men in the Canadian ranks, because the medical personnel soon began talking about the corps' looming move to the Flanders front. To add further credence to the deception, Currie sent two infantry battalions north and placed in the line. The corps wireless section went north, too, and began transmitting messages in the hope that the Germans would intercept them. Its presence would suggest the arrival of the corps' advanced party to the area.⁹ The British, meanwhile, increased the amount of RAF activity over the Flanders front, and even constructed dummy airfields in the area.¹⁰ Although these efforts helped confuse the Germans about the Canadians' whereabouts, they still expected a British attack somewhere further south in the 4th Army area -- they just did not know exactly where or when.¹¹ Still, when the assault came, surprise was complete.¹²

The German defences in the area were not strong. They "consisted chiefly of unconnected elements of trenches, and a vast number of machine gun posts scattered here and there, forming a very loose but very deep pattern." The forward defensive zone contained some twenty-four battalions of infantry, with a further six battalions in support. There were also four divisions available in reserve.¹³ As ominous as these figures might appear, the fact is the German units were below strength and in an exhausted state, having suffered heavily in their own recent

⁹ John Swettenham, *McNaughton, Vol. 1, 1887 - 1939* (Toronto: The Ryerson Press, 1968), 135.

¹⁰ Gregory Blaxland, *Amiens: 1918* (London: Frederick Muller Ltd., 1968), 161.

¹¹ G.W.L. Nicholson, *Official History of the Canadian Army in the First World War, Canadian Expeditionary Force 1914 - 1919* (Ottawa: Queen's Printer, 1962), 389 - 390.

¹² S.F. Wise, "The Black Day of the German Army: Canadians and Australians at Amiens, August 1918," in Peter Dennis and Jeffrey Grey, eds., *1918: Defining Victory* (Canberra: Department of Defence, Army History Unit, 1999), 23 - 24. Wise cites a German situation map that places the Canadians, as of 8:00 a.m. on August eighth, west of Arras in the Vimy - Lens area -- no where near Amiens.

¹³ Arthur Currie, "Canadian Corps Operations. Synopsis: Interim Report," *Report of the Ministry, Overseas Military Forces of Canada 1918* (London: King's Printer, 1919), 136.

offensive. An outbreak of influenza added to their weakness.¹⁴ The 2nd Canadian Division recorded how the Germans were holding their front lightly and that their positions indicated they were suffering from a lack of morale and discipline. It noticed that "Although...there was an abundance of tools and material, very little work had been done on the defences."¹⁵ The Germans, in other words, had not prepared another Vimy Ridge. Nevertheless, the Canadians did not expect an easy time.

Intelligence work, as usual, remained vital for forming plans, but because the Canadians were on the move much of the time, they gathered little intelligence for themselves. Most of the counter battery information, for example, came from the Australians already in the line, and from British sound rangers. Sound rangers were extremely important for locating hostile batteries prior to the Amiens operation. This was because for two weeks before the assault a heavy fog shrouded the area, preventing most air and ground observation.¹⁶ To collect and arrange this and other intelligence on behalf of the Canadian Corps, a number of staff officers were attached to the Australians in the days prior to the Canadians assuming control of their portion of front.¹⁷ Other information came from locals, and the French Army on the Canadians' right flank (at whose headquarters the

¹⁴ Shane Schreiber, *Shock Army of the British Empire. The Canadian Corps in the Last 100 Days of the Great War* (Westport, CT.: Praeger, 1997), 41.

¹⁵ NAC, M.G. 30 E6 (Burstall Papers) Vol. 3, Folder 21. "2nd Canadian Division Narrative of Operations From March 13th to Nov. 11th 1918."

¹⁶ Bill Rawling, *Surviving Trench Warfare, Technology and the Canadian Corps, 1914-1918* (Toronto: University of Toronto Press, 1992), 189-190; H. St. J.L. Winterbotham, "Geographical and Survey Work in France, Especially in Connection With Artillery," *Journal of the Royal Artillery* 46 (1919), 171.

¹⁷ The Canadian Corps was assisted in its planning, too, having been given the Australian artillery fire plan towards the end of July. Certainly, Canadian officers are known to have visited the Australians at the end of July. In his diary, the Australian official historian, C.E.W. Bean, noted that on July twenty-eighth he met Brigadier-General N.W. Webber and Major-General E.W.B. Morrison of the Canadian Corps at the Australian Corps' headquarters. See Wise, "The Black Day of the German Army," 23; also Nicholson, *Official History*, 389.

Canadians placed liaison officers), and from the French *Bureau des Ponts et Chaussées* which provided details on the rivers and bridges the Canadians had to cross.¹⁸ Intelligence also came from the Cavalry Corps, which included the Canadian Cavalry Brigade, since this formation operated around Amiens earlier in the year during the German Spring Offensive. Other information came from some of the units in the Motor Machine Gun Brigade, as it too had worked in the area prior to the Canadian Corps' arrival.¹⁹

Planning by Canadian divisions and lower levels of command largely consisted of fine-tuning plans already prepared by the 4th Army and corps headquarters. On the thirty-first of July, when divisional commanders learned of the attack, they were given the preliminary plans and asked for their suggestions on any changes they needed. Once brigades learned of the plans, on August first, brigade commanders and their brigade majors completed most of the finer details for their particular formation.²⁰ Battalion officers had so little time to orient themselves and their commands on the ground that they had to rely on maps, aerial photographs, and mosaic and oblique photographs to familiarize themselves with the ground. Each officer received copies, however, and in the hours before the assault they reviewed with their men the more salient features of the terrain.²¹ This limited perusal of the available intelligence was considered "sufficient...for troops to pick up such detail as was necessary during the one or two days immediately prior to the operation" -- an indication of the skill level attained by Canadian troops,

¹⁸ NAC, R.G. 9 III D2, Vol. 4789, Folder 8. "L.C. Intelligence Notes No. 1," August 2, 1918; Swettenham, *McNaughton*, 138 - 139.

¹⁹ S.F. Wise to Author, May 25, 1999.

²⁰ Ian M. Brown, "Not Glamorous, But Effective: The Canadian Corps and the Set-piece Attack, 1917 - 1918," *The Journal of Military History* 58.3 (July 1994), 432.

²¹ NAC, R.G. 9 III C3, Vol. 4074, Folder 2, File 8. 1st Division's preliminary instructions for the Amiens offensive, August 4, 1918.

and the confidence higher command had in their tactical abilities.²²

Unlike at Passchendaele where the Canadians pushed forward in 500 yard increments because of the mud, and in order to avoid being caught in the main German battle zone, the final plans for Amiens asked the Canadians to cross the entire German defensive position in one grand sweep: the outpost line, the main battle zone and the German artillery line. The total distance to be covered was about 14,000 yards, or around eight miles, which was a far greater depth than the Canadians had previously attempted. Objectives were marked by coloured lines: the Green and Red Lines marked intermediate objectives, while the Blue and Blue Dotted Lines marked the final objectives of the first day. The plan had the 3rd Cavalry Division, attached to the Canadian Corps for the Amiens operation, and the Canadian Independent Force, exploiting beyond the Blue Dotted Line if possible, collecting intelligence on the latest German dispositions, disrupting German rear areas, and generally causing as much chaos as possible to German communications.²³

Close coordination of all units was important for the success of the operation. Much of this coordination came through preplanning. Each command had its task to perform and timetable to follow. This was especially important for artillery work, whose creeping barrage advanced at the estimated walking speed of the attacking infantry. Scheduling was also important for harassing fire programs. The heavy artillery, for example, brought “distant harassing fire to bear” on

²² NAC, M.G. 30 E6 (Burstall Papers) Vol. 3, Folder 21. “2nd Canadian Division Narrative of Operations From March 31st to November 11th 1918.”

²³ The Canadian Independent Force (CIF), advancing along the corps’ right flank, was comprised of the 1st and 2nd Canadian Motor Machine Gun Brigades, the Canadian Corps Cyclist Battalion, and a section of six-inch mortars mounted in trucks. These were all under the command of Brigadier-General Raymond Brutinel. In addition to its mobile fire-power, the CIF proved to be a valuable intelligence gathering force. It used Mark III wireless sets “mounted in a special car” for long range communication purposes. In fact, wireless was the only means of communicating this force possessed, and through it the force remained in contact with the corps report centre directly.

German routes of approach, railways, assembly points, and so on, when not employed on their counter battery assignments.²⁴ At the same time the Canadians, in what had become a familiar pattern in their planning, prepared march tables for German reinforcing and reserve troops. At pre-determined times during the battle the Canadians fired concentrated artillery fire at suspected enemy assembly areas and routes of approach. The effect of these concentrations “was excellent,” reported the Counter Battery Office in an after action report. The secrecy of the attack also precluded the registration of the artillery. Instead, the gunners had to rely on predicted fire when shelling every known German battery, strong point and machine gun nest. To help ensure the accuracy of this fire the CCSS, in the days and hours before Zero, surveyed every friendly battery position and prepared battery boards for the gunners in what was “a race against time.”²⁵

Meantime, the counter battery fire program, also worked out in advance, proved incredibly accurate on the day of battle. A number of German guns, in fact, were captured without their having fired a shot in retaliation. The 2nd Divisional Artillery reported:

the effect of our counter-battery work was conclusively evident. In one case there were horses and men lying dead or wounded round the position where efforts were apparently being made to get the guns away; in another, four 15 [centimetre Howitzers] were found, two with their camouflage still on, one where it was evident that attempts had been made to blow it up and another which although

²⁴ NAC, M.G. 30 E81(Morrison Papers) Vol. 2, Folder: Artillery Corps: Orders and Instructions 1917 - Oct. 1918. Artillery Order No. 125, addendum, August 4, 1918.

²⁵ A survey team was detailed to each divisional artillery and to the heavy artillery “in order that positions could be accurately resected as soon as located” by artillery officers sent to the Amiens sector in advance of the main body. See NAC, M.G. 30 E157 (Crerar Papers) Vol. 22, Folder 3. “Artillery Notes on Attack by Canadian Corps, August 8th, 1918,” prepared August 24, 1918. Also see R.G. 9 III C1, Vol. 3923, Folder 10, File 4. Counter Battery Office, “General Notes on Operations Commencing August 8th, 1918,” prepared August 22, 1918; File 5. “Attack By Canadian Corps, August 8th., 1918, 2nd. Canadian Divisional Artillery, Report on Operations,” August 22, 1918.

ready for action had not been fired. Every position captured showed signs of the effect of our recent shelling.

McNaughton wrote after the battle that there was "little hostile retaliation. It appears that we have swamped his [the German] batteries." The weak German artillery response throughout much of the August eighth advance meant that many hundreds of Canadian lives were spared. Indeed, the effectiveness of the counter battery fire and the counter battery intelligence proved a major factor in the victory, as the limited German artillery response meant that Canadian and Allied troops advanced with little artillery molestation.²⁶

The infantry, of course, had its assigned objectives, timetables, and lines of advance, as did the machine gun and trench mortar units, the tanks, and the engineers. Machine guns and trench mortars contributed to the initial barrages, and helped defend the newly won positions during the consolidation phase. During the advance they followed specific units, and cooperated with them. Similarly, the tanks went for pre-assigned objectives. Engineering work was carried out to a definite plan, as specific roads required repair, and bridges needed rebuilding as the advance progressed in order for the artillery to move forward to their new positions.²⁷

Communications were crucial during battles as fluid as Amiens. The dearth

²⁶ NAC, R.G. 9 III C1, Vol. 3923, Folder 10, File 4. R.G. 9 III C1, Vol. 3923, Folder 10, File 4. Counter Battery Office, "General Notes on Operations Commencing August 8th, 1918," prepared August 22, 1918; also R.G. 9 III C1, Vol. 3923, Folder 10, File 5. "Attack By Canadian Corps, August 8th., 1918, 2nd Canadian Divisional Artillery Report on Operations;" James Edmonds, ed., *Military Operations France and Belgium, 1918, Volume IV, 8th August - 26th September, The Franco-British Offensive* (London: His Majesty's Stationary Office, 1947), 41. McNaughton's quotation can be found in Swettenham's, *McNaughton*, 144.

²⁷ NAC, R.G. 9 III C3, Vol. 4105, Folder 20, File 4. 4th Brigade instructions, August 6, 1918; "Narrative of Operations by 4th Canadian Infantry Brigade on 8th August, 1918; and the 19th Battalion's Order No. 90; Vol. 4148, Folder 13, File 2. 3rd Division's L.C. Instructions No. 1, August 5, 1918.

of planning time, and the depth of the advance, meant plans could not account for every contingency beforehand. If the infantry on the scene, wielding the weapons in hand, faced unexpected roadblocks, and could not subdue the defenders themselves, they had to rely on the assistance of one or more of the supporting arms (artillery, tanks, trench mortars, machine guns). They could obtain this assistance personally if the weapons and crews were nearby, or they could contact the supporting arm through some form of liaison and communication arrangement, or through some other observer acting as the supporting arm's forward eyes and ears. Whatever method was reached for, the use of support weapons demanded the timely dissemination of accurate intelligence. Within the infantry, the signals and intelligence arrangements "were organized upon the same lines that had proved effective on previous occasions at the SOMME, at VIMY RIDGE, HILL 70 and elsewhere."²⁸ This meant that, in most cases, the Canadians used a series of report centres and observation posts to monitor the advance, and watch for signals (although early in the day this was difficult because of ground mist and fog). The 12th Brigade tried a variation of the report centre system. Figure 12.1: "12th Brigade's Moving Observation Posts in an Advance" illustrates how it worked. The brigade employed combinations of OPs and visual stations that moved forward with the advance in order to keep in touch with events at the front. The brigade commander was pleased with the overall result. Various staff and commanding officers, along with personnel from the intelligence sections also reconnoitred the front for the latest news. The scout officer in the 85th Battalion was all over the front on such tasks. The unit's historian wrote that Lieutenant Rogers

²⁸ NAC, M.G. 30 E100 (Currie Papers) Vol. 37, Folder 167. 3rd Brigade's Report on Operations August 3rd to 20th, 1918; R.G. 9 III C3, Vol. 4105, Folder 20, File 4. 19th Battalion Order No. 90.

Figure 12.1: 12th Brigade's
Moving Observation Post in an Advance

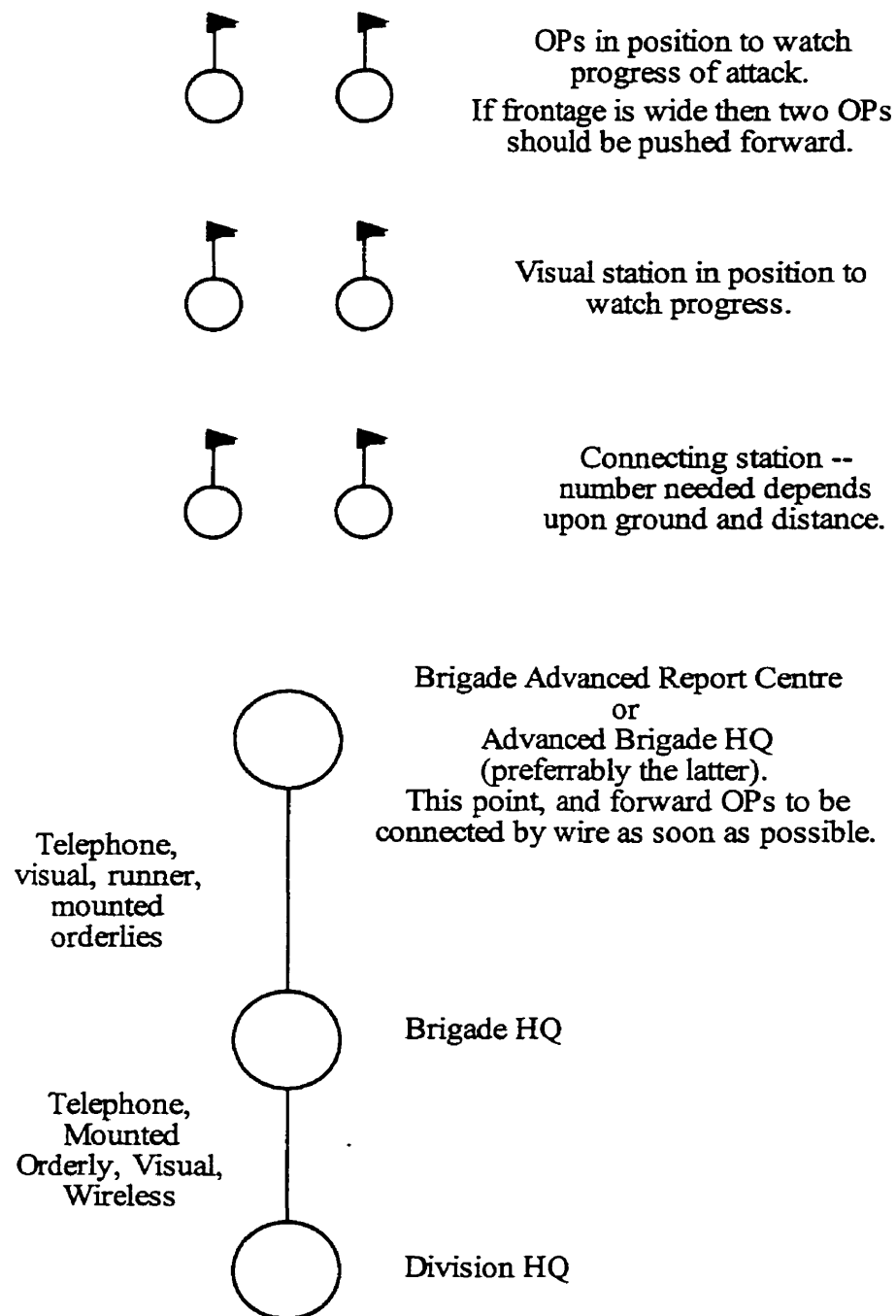

(Based on diagram in R.G. 9 III C3, Vol. 4238, Folder 4, File 5.
 "12th Canadian Infantry Brigade, Report Llandoverly Castle Operation 8th August -
 13th August 1918).

was constantly at work in the most dangerous parts of the area obtaining first hand information of any enemy movements, posts, machine guns, sniping and on two occasions he penetrated within the enemy lines and found them forming for a counter attack. The prompt warning he was able to give to the forward troops prevented a surprise and ensured the repulse of the enemy. While leading a party to out flank an enemy machine gun position he received a bullet wound in the shoulder.

The sergeant who took over from the scout officer was himself “continually from one flank of the Battalion to the other, getting information regarding the situation of his own Battalion as well as that of the enemy. His reports...were invaluable and obtained at great risk.”²⁹ Advancing troops also carried flares to signal airplane contact patrols. Further back the artillery, divisions and corps headquarters established their own report centres for receiving and sending news. These kept the relevant commands informed of events at the front, as it was through these centres that they received reports on the fighting from all sources, including the various ground and air observers. This made it far easier for rear area commanders to follow the fighting, to take advantage of fleeting opportunities, to adjust the timing of the advance, and to commit reserves at the appropriate times.

Liaison officers made a valuable contribution at Amiens, and throughout the 100 Days, because of their intelligence gathering and transmission capabilities. They also helped coordinate the action of the supporting arms. Liaison between the infantry and their accompanying tanks, for example, was important since it was one of the tanks' jobs to help eliminate points of resistance surviving the initial bombardment and the creeping barrage. Tactical control of the tanks fell to the infantry brigades they were affiliated with, reverting to tank command control only after “the final dispositions have been taken up and communications established.”

²⁹ Joseph Hayes, *The Eighty-Fifth in France and Flanders* (Halifax: Royal Print & Litho Limited, 1920), 125 - 127, 201 - 202.

In the 1st Division, this meant the commander of the 4th Tank Battalion was at the headquarters of the 3rd Infantry Brigade, while his second in command remained at the divisional headquarters acting as the tank battalion's liaison officer. A telephone connection kept the two officers in contact with each other. Three hours after Zero, the second in command moved up to the brigade headquarters, and the tank battalion commander moved forward with runners to keep in touch with his tank companies. Due to the fog and the speed of the advance, very little information came back by runner, though. Most news reaching tank headquarters came from the wounded returning from the front. At the same time, every infantry detachment allotted tanks detailed one infantryman (a scout) to ride in each tank. It was this man's duty to watch for signals from the infantry and report their advance to his tank's commander, thereby keeping him informed of the infantry's immediate needs and requirements. It was also this man's job to operate the signals from the tank to the infantry. The two pigeons accompanying each tank section were of little use. "They were very slow, presumably owing to the fog and the distance away of the Lofts."³⁰

Of more use was the "wireless Tank" attached to the tank battalion headquarters. It "proved to be a useful adjunct during the later stages of the Battle, and accompanied Battalion H.Q. as it moved forward." Similarly, the motor cycle working with the tanks "proved to be very useful in keeping up Communication" between the forward units and rear commands. Overhead, specially designated airplanes watched the tank advance and by this or some other means, information on the tanks' progress reached rear area headquarters. Indeed, the 4th Tank Battalion reported that "In all cases...the closest liaison was kept between Tank

³⁰ NAC, M.G. 30 E6 (Burstall Papers) Vol. 1, Folder 1. 2nd Canadian Division Operation Order No. 222, August 5, 1918; R.G. 9 III C3, Vol. 4238, Folder 4, File 3. "12th Canadian Infantry Brigade, Order No. 1," August 6, 1918; M.G. 30 E100 (Currie Papers) Vol. 37, File 167. "4th Tank Battalion Report on Operations With 1st Canadian Division. Luce Valley, August 8th, 1918."

Sections and Infantry Battalion Commanders,” which no doubt helped keep up the momentum of the attack.³¹ In fact, during the early going, the tanks “did excellent work...accounting for many machine gun nests and greatly assisting the advance of the Infantry.”³² While the tanks, as the 1st Battalion discovered, “proved to be satisfactory for the initial break-through,” they were not as effective in their exploitation role.³³ Other commands, such as the 4th Infantry Brigade, found that “Owing to the density of the fog prevailing, the tanks were not able to reach the jumping-off lines on time, and subsequently lost direction and did not support the Infantry as had been expected. The foggy weather prevented the desired co-operation.”³⁴ The Canadians’ limited training with tanks also limited the success of infantry-tank, and cavalry-tank cooperation.³⁵

Similarly, coordinating the action of the artillery necessitated close cooperation with the infantry. Officer patrols, FOOs, and LOs all did their part in seeing that the gunners kept in touch with the infantry. As to be expected, sometimes their efforts fell short, especially if communications were unavailable,

³¹ NAC, M.G. 30 E100 (Currie Papers) Vol. 37, File 167. “4th Tank Battalion Report on Operations With 1st Canadian Division. Luce Valley, August 8th, 1918.”

³² NAC, M.G. 30 E6 (Burstall Papers) Vol. 3, Folder 21. “2nd Canadian Division Narrative of Operations From March 13th to Nov. 11th 1918.”

³³ NAC, R.G. 9 III C3, Vol. 4028, Folder 17, File 20. 1st Battalion to 1st Brigade, August 23, 1918, notes on recent fighting.

³⁴ NAC, R.G. 9 III C3, Vol. 4105, Folder 20, File 4. “Narrative of Operations by 4th Canadian Infantry Brigade on 8th August, 1918.”

³⁵ NAC, R.G. 9 III C3, Vol. 4148, Folder 13, File 2. Canadian Corps L.C. Instructions No. 1; C.P. Stacey, “The Battle of Amiens 1918,” *Canadian Army Journal* 4.8 (January 1951), 6; Rawling, *Surviving Trench Warfare*, 195; Dean Chappelle, “The Canadian Attack at Amiens, 8 - 11 August 1918,” *Canadian Military History* 2.2 (Autumn 1993), 95 - 96. This was especially the case with the Whippet Tanks operating with the 3rd Cavalry Division. The Whippets were light tanks whose task was to support the cavalry and reconnoitre the forward areas. The cavalry had never trained with tanks before, however, and found that the tanks could not keep up when crossing open country. Then, when machine guns were encountered, the cavalry could not keep pace with the tanks. Horse flesh, of course, is not as resistant to bullets as armour. Cooperation between the cavalry and other ground troops was better arranged. Men mounted on motorcycles rode between the two service arms, while cavalry liaison officers were with the various infantry headquarters to smooth the exchange of information.

something the 10th Battalion discovered firsthand. At one point in the advance the 10th Battalion could not reach the gunners firing in support to tell them that they were firing short. The battalion estimated that forty percent of its casualties on August eighth were caused by friendly artillery fire. "The liaison between the Infantry and the Artillery at that time was practically nil," complained the battalion commander.³⁶ Still, liaison was important for coordination, and as telephones were the principle means of communication within the artillery, the artillery made special efforts to ensure that telephone lines were in place and maintained, and that the artillery remained tapped into the larger communication network throughout the battle. The signal officer in the heavy artillery described the communication arrangements this way:

The system followed in the first case was based on the principle of 'stepping up' wherein forward exchanges were established at regular intervals along a main trunk route, so plotted beforehand as to follow the centre of the corps area. Immediately before being established the actual co-ordinates of each forward exchange was selected, with the main object of reaching as closely as possible the centre of the new brigade area, and reducing to a minimum the average distance from all the units and formations that it was expected to serve.

The frequency with which these exchanges were established depended on the rate of the advance, but provision always had to be made for maintaining a maximum of from six to eight at one time...

The brigades and units, on moving to forward positions, laid out and maintained their own lines to the nearest exchange of the trunk system.³⁷

Cable wagons were used, and did "excellent work in quickly laying lines between headquarters and their units." The artillery attempted lateral communications as well, but maintaining these lines proved difficult. A shortage of men and cable was

³⁶ NAC, R.G. 9 III C3, Vol. 4053, Folder 24, File 16. 10th Battalion to 2nd Brigade, August 24, 1918.

³⁷ NAC, R.G. 9 III C1, Vol. 3920, Folder 2, File 4. Heavy Artillery signal officer's "Notes on Experiences Gained In Maintaining Communications in Mobile Warfare (Advance). Canadian Corps Heavy Artillery."

to blame, as was the general difficulty of laying lateral lines between forward-moving commands. Notwithstanding these difficulties, the signal and intelligence gathering arrangements in place by the artillery were very successful. The 2nd Divisional Artillery went so far as to say that "From the very outset of the attack information came pouring in and it was possible almost all day to keep track of the movements of Infantry, Artillery, Tanks and Cavalry."³⁸

The distance covered in the assault meant the infantry advanced beyond the barrage range of their supporting field artillery -- somewhere around the Green Line. At that point the heavy howitzers, with their longer ranges, and working to a pre-arranged shelling program, carried the infantry to the Red Line, which marked the maximum range of most of the heavy guns. Super howitzers were available beyond this point, but for the most part, the intensive barrage ended. As the infantry reached this point each gun fired a smoke shell as their last projectile, and in this way informed the infantry that the protection afforded by the creeping barrage was over and that the guns were now limbering up and moving forward to regain supporting range.³⁹ Previous training in the all-arms battle, however, meant the infantry could continue to advance even when without their artillery cover. In the all-arms battle, tanks, heavy machine guns, trench mortars, mobile artillery, airplanes and the infantry worked together in order to overpower strong points not eliminated by the preliminary bombardment, or lying outside its range.

Although the mobile artillery brigades following the infantry in close support were less able to help the infantry than desired, this was not due to any intelligence failing. Simply put, it was very difficult to move guns forward, reposition them, and keep them supplied in a moving battle. The 1st Battalion noted

³⁸ NAC, R.G. 9 III C1, Vol. 3923, Folder 10, File 5. "Attack By Canadian Corps, August 8th., 1918, 2nd Canadian Divisional Artillery Report on Operations."

³⁹ NAC, M.G. 30 E157 (Crerar Papers) Vol. 22, Folder 3. "Artillery Notes on Attack by Canadian Corps, August 8th, 1918," prepared August 24, 1918.

that "Excellent targets for artillery were seen by the most advanced troops; (these targets as a rule were hostile batteries on the move and in action, Transport withdrawing etc.) but our own artillery not being available the opportunity of dealing with them was missed." The 7th Battalion, as well, commented on lost opportunities because of a lack of artillery support at critical moments. These and other commands recommended that a battery of field artillery, or even just one or two guns, be attached to infantry battalions in the future for quickly taking on targets holding up the advance.⁴⁰ There were successes, too, but more training with mobile guns was necessary.⁴¹

Since the assault comprised units from more than just the Canadian Corps, the Canadians had to coordinate their efforts with their neighbours to ensure mutual support and understanding, and for sharing intelligence throughout the action. On the corps' left were the Australians, on its right the French. As General Currie wrote after the war: "The Canadian Corps being, as it were, the spearhead of the

⁴⁰ NAC, R.G. 9 III C3, Vol. 4053, Folder 24, File 16. 7th Battalion to 2nd Brigade, August 24, 1918; 8th Battalion to 2nd Brigade, no date; Vol. 4028, Folder 17, File 20. 1st Battalion to 1st Brigade, August 23, 1918, notes on recent fighting. (These recommendations were adopted in subsequent actions).

⁴¹ Similar problems occurred with the supporting trench mortars. These weapons, along with their ammunition, were difficult to transport because of their weight. As a result, the trench mortars were not always in place to be of use. On the other hand, Vickers machine guns, although heavy, had more success in supporting the advance. Their main task, however, was in providing close protective fire during the consolidation phase, and in that they were very successful. Both weapons systems had liaison officers attached to the infantry as well as having their commanding officers stationed at the infantry brigade headquarters they were supporting. See M.G. 30 E157 (Crerar Papers) Vol. 22, Folder 3. "Artillery Notes on Attack by Canadian Corps, August 8th, 1918," prepared August 24, 1918; R.G. 9 III C4, Vol. 4252, Folder 24, File 3. Additional instructions for Artillery Order No. 125, August 4, 1918; R.G. 9 III C1, Vol. 3923, Folder 10, File 5. "Attack By Canadian Corps, August 8th., 1918, 2nd Canadian Divisional Artillery Report on Operations;" R.G. 9 III C3, Vol. 4016, Folder 33, File 13. 1st Division to Canadian Corps, August 17, 1918; Vol. 4028, Folder 17, File 20. 1st Battalion to 1st Brigade, August 23, 1918, notes on recent fighting; and Bill Rawling, "Technology in Search of a Role: The Machine Gun and the CEF in the First World War," *Material History Review* 42 (Fall 1995), 98.

attack the movements of the other formations were to be synchronized with ours.”⁴² This was done at the planning level by arranging for a common Zero Hour. Further, the Canadians exchanged liaison personnel with their neighbours. The 2nd Canadian Division, for example, instructed each infantry brigade to detail a senior officer (mounted) to the neighbouring divisions to act as liaison officers. This meant sending officers to the 1st Canadian Division working on its right and to the 2nd and 5th Australian Divisions working to its left.⁴³ Within the division each brigade exchanged officers as well, the 4th Brigade wrote that “Liaison was maintained throughout with the 3rd Canadian Infantry Brigade on the Right and the 7th Australian Brigade on the left.”⁴⁴ The Canadians also knew the meaning of the various Australian light signals, and so could respond to them. Green over green over green, for example, was the Australian SOS signal.⁴⁵ In the end, cooperation with the Australians was very good. The 2nd Canadian Division said that it “was almost better than could be hoped for. Many instances occurred where our troops were held up...[by] a series of strong machine gun nests, and in such instances the Australians assisted our advance materially by their Lewis gun fire, as well as by sending small parties of Infantry to take part in the assault.”⁴⁶ The 3rd Canadian Division maintained touch with the neighbouring French command through an international force created for just that purpose. It was comprised of a section from

⁴² Arthur Currie, “Canadian Corps Operations. Synopsis: Interim Report,” *Report of the Ministry, Overseas Military Forces of Canada 1918* (London: King’s Printer, 1919), 137.

⁴³ NAC, M.G. 30 E6 (Burstall Papers) Vol. 1, Folder 1. 2nd Canadian Division Operation Order No. 222, August 5, 1918. The other divisions did this as well. The 4th Division, for example, had officers at the 3rd Division’s HQ, and with each brigade in the 3rd Division. R.G. 9 III C3, Vol. 4148, Folder 13, File 2. 3rd Division’s L.C. Instructions No. 1.

⁴⁴ NAC, M.G. 30 E6 (Burstall Papers) Vol. 1, Folder 1. 4th Brigade’s narrative of operations.

⁴⁵ NAC, R.G. 9 III C3, Vol. 4148, Folder 13, File 2. 3rd Division’s L.C. Instructions No. 1.

⁴⁶ NAC, M.G. 30 E6 (Burstall Papers) Vol. 3, Folder 21. “2nd Canadian Division Narrative of Operations From March 13th to Nov. 11th 1918.”

the French 94th Regiment and a platoon from the Canadian 43rd Battalion, and was under the command of a French officer. The Canadian Independent Force, advancing next to the French, also kept in touch with the French command on its right via wireless to an LO at the French headquarters.⁴⁷ Meanwhile, the 3rd Canadian Division and the 42nd French Division exchanged liaison officers, although language difficulties limited their usefulness.⁴⁸ Continuous wave wireless sets,⁴⁹ manned by corps and army operators, were also with the neighbouring French corps and division for liaison purposes. "Considerable traffic was handled, but, as was to be expected, it was chiefly between Divisions; only situation reports passing between the Corps."⁵⁰ Still, the arrangements were valuable, and helped keep the advancing armies aligned. They also kept the Canadians generally informed about the progress of formations on its flanks.

As the entire Canadian Corps was taking part in the assault, corps headquarters had to try and coordinate the actions of each Canadian division as well. Helping to control the mobile battle and gather the necessary intelligence for command purposes was the RAF squadron attached to the corps. As Wise notes in his *Canadian Airmen and the First World War*, during the first day of the assault "The RAF's overriding concern...was to assist the ground attack." The next day its efforts shifted to bombing the bridges over the Somme River to prevent German

⁴⁷ For example, the CIE's No. 2 Group at one point contacted the French 94th Battalion, and called on it for assistance in taking out some troublesome machine gun nests. See, M.G. 30 E100 (Currie Papers) Vol. 37, File 167. "Summary of Operations[,] Canadian Independent Force[,] 8-8-18 to 10-8-18."

⁴⁸ NAC, R.G. 9 III C3, Vol. 4148, Folder 13, File 2. Canadian Corps L.C. Instructions No. 1; James Edmonds, ed., *Military Operations France and Belgium, 1918, Volume IV, 8th August - 26th September, The Franco-British Offensive* (London: His Majesty's Stationary Office, 1947), 42 - 43.

⁴⁹ Continuous wave wireless sets had a far greater range than earlier model wireless sets. Messages were also clearer, and the sets, being more powerful, used a smaller, less conspicuous aerial.

⁵⁰ NAC, M.G. 30 E5 (Bovey Papers) Vol. 1, Folder 2. "Report on Wireless Communications in the Canadian Corps Area, During the Offensive on the Amiens Front, August 8th -- August 22nd, 1918."

reinforcements from reaching the threatened areas. At Amiens, "More than in any previous battle of the war...planned co-operation of the closest kind between the air and ground forces" was striven for. As such, various squadrons flew contact patrols for the infantry, the artillery and the advancing cavalry and tanks, they also acted as artillery spotters and observers and offered close ground support to the assaulting troops. Where opportunity targets presented themselves, aircraft armed with machine guns and bombs engaged them at once.⁵¹

The RAF was not the only force trying to keep corps headquarters informed of events at the front. The Canadian Corps Survey Section, and the Canadian Independent Force, were also on hand.⁵² Prior to the assault the CCSS played a valuable role by surveying gun positions and preparing battery boards. During the battle its observation posts and teams of scouts concentrated on gathering and transmitting intelligence of a general nature concerning events at the front. The observation posts were equipped with wireless for quickly relaying any news gathered, and "A great deal of valuable information was sent in by these [wireless] sets." Between August eighth and nineteenth, "20,000 words were sent over these sets, including 573 actual messages [regarding] many fleeting targets and bits of information picked up by the observers."⁵³ German speaking NCO's went forward with the scout groups to gather firsthand information from prisoners. These scout teams also visited the headquarters of the attacking battalions where they obtained short reports on the action. This information was carried back to the CCSS OPs, and transmitted to the CCSS report centre located alongside the Counter Battery

⁵¹ S.F. Wise, *Canadian Airmen and the First World War, The Official History of the Royal Canadian Air Force, Vol. 1* (Toronto: University of Toronto Press, 1980), 523.

⁵² Mention has already been made of the cavalry. See footnote 35.

⁵³ NAC, M.G. 30 E5 (Bovey Papers) Vol. 1, Folder 2. "Report on Wireless Communications in the Canadian Corps Area, During the Offensive on the Amiens Front, August 8th -- August 22nd, 1918."

Office. Information of use to the artillery was used right away, with the rest being sent to corps headquarters for its consideration.⁵⁴

The Canadian Independent Force (CIF), working well out in front of the advance, gathered information on activities in and about the German rear areas. The CIF, in turn, sent out its own reconnaissance parties to check on the general situation. Private A.L. Bebeau, for example, "while scouting in his Motor Cycle rode through the enemy's lines no less than ten times, on each occasion drawing the enemy's fire and forcing him to disclose his Machine Gun positions, which when once located were successfully dealt with by the Armoured Cars and Machine Gun Batteries following up." On another occasion, Private B.H. Johnson "displayed great courage in entering the enemy's lines to obtain information. Twice his Machine [motorcycle] was hit by shell fire, but under heavy fire he was successful in returning with valuable information."⁵⁵ Officers further back, meanwhile, kept careful watch over the German lines. It was not uncommon for Brigadier-General Brutinel to make a personal reconnaissance when necessary. The CIF's use of long range wireless sets meant that the information it supplied the rear was red-hot, and therefore extremely valuable to corps and army commands for reading the German's response to the Allied advance. On August tenth, to avoid interfering with the French Division's wireless operations, the Canadian Independent Force altered its sending wavelength. As a sign of its importance to intelligence collection, as soon as this frequency change was made

The telephone exchange at Corps Headquarters was immediately besieged by a flood of telephone calls from units all over the British

⁵⁴ NAC, R.G. 9 III C1, Vol. 3923, Folder 10, File 4. R.G. 9 III C1, Vol. 3923, Folder 10, File 4. Counter Battery Office, "General Notes on Operations Commencing August 8th, 1918," prepared August 22, 1918.

⁵⁵ NAC, M.G. 30 E100 (Currie Papers) Vol. 37, File 167. "Summary of Operations[,] Canadian Independent Force[,] 8-8-18 to 10-8-18." These privates were probably members of the Canadian Cyclist Battalion. Men from that unit acted as scouts for the CIF, and helped screen its advance.

front asking why the Canadian Independent Force stations had been closed down. It appeared that all wireless stations within the Army had been listening in to this traffic in order to obtain a first hand story of the conditions in the enemy back country, since the Independent Force had penetrated very deeply into the German lines.⁵⁶

During the battle over 120 messages were transmitted, and because the Canadian Independent Force was mobile and well out in front of the advance "Much valuable information was contained in these messages."⁵⁷

Even with all of the above means available for securing and transmitting news on the fighting there were gaps in the information reaching the various headquarters (fog and enemy action slowed the transmission of news, for example). When this occurred the tactics the infantry learned while training for open warfare were of enormous help, as the infantry could carry on without minute instruction from above. The 7th Battalion stated that "As far as this Battalion was concerned, isolated Machine Guns and Rifle fire, were all that had to be dealt with...It was amply demonstrated that the training in open warfare undergone whilst the Corps was in rest was all to the good, by the rapidity with which they were overcome with very light casualties to ourselves." Other battalions made similar claims. In the 10th Battalion "the value of the recent training in open warfare was very apparent, especially the methods of overcoming machine gun opposition, and the tactical exercises which involved lengthy advances over more or

⁵⁶ W. Arthur Steel, "Wireless Telegraphy in the Canadian Corps in France," *Canadian Defence Quarterly* 8.1 (October 1930), 90 - 91.

⁵⁷ NAC, M.G. 30 E5 (Bovey Papers) Vol. 1, Folder 2. "Report on Wireless Communications in the Canadian Corps Area, During the Offensive on the Amiens Front, August 8th -- August 22nd, 1918;" Currie, "Canadian Corps Operations," 136; M.G. 30 E100 (Currie Papers) Vol. 37, File 167. "Summary of Operations Canadian Independent Force 8-8-18 to 10-8-18."

less unknown territory, were very useful.”⁵⁸ The 5th Brigade wrote how on the second day of the battle the German machine gun nests still surviving

were dealt with entirely by manoeuvre. Small parties of scouts followed by Lewis Guns worked up ditches, sunken roads and other dead ground until the enemy’s Machine Guns were put out of action or forced to retire by enfilade fire from a flank. When this had been accomplished a signal was given to the Infantry, who meantime had remained under cover, that they could advance. Successive positions were dealt with in this manner without incurring undue casualties.⁵⁹

The 4th Brigade wrote how one known strong point, originally a tank objective, had to be removed by the infantry. It seems that the tank allotted the task of silencing that particular point did not arrive on the scene as scheduled. The infantry advance stalled until the commander on the ground organized an assault using the latest infantry tactics, and overcame the resistance by manoeuvre, allowing the attack to proceed.⁶⁰ The 1st Division agreed that the new tactics were valuable during the assault.

The methods of infiltration taught during the rest period of this Division were found to be sound in every way. The combination of fire and movement, together with the employment of Scouts and Snipers pushed well forward and Lewis Guns employed to give covering fire and to develop superiority in fire over hostile Machine Guns, proved effective.⁶¹

In the end, Amiens was a great success, one that marked the beginning of the end of the German war effort. Intelligence had played an important role in that

⁵⁸ NAC, R.G. 9 III C3, Vol. 4053, Folder 24, File 16. 7th Battalion to 2nd Brigade, August 24, 1918. See same folder, 10th Battalion to 2nd Brigade, August 24, 1918.

⁵⁹ NAC, M.G. 30 E6 (Burstall Papers) Vol. 1, Folder 1. 5th Brigade’s narrative of operations.

⁶⁰ NAC, R.G. 9 III C3, Vol. 4105, Folder 20, File 4. “Narrative of Operations by 4th Canadian Infantry Brigade on 8th August, 1918.”

⁶¹ NAC, M.G. 30 E60 (Matthews Papers) Vol. 7, Folder 25. 1st Division to Canadian Corps, August 17, 1918.

victory. The set-piece phase of the assault was dependent on a proliferation of accurate intelligence, while maintaining control in the open phase of the fighting was equally dependent on news from the front. This information helped bring the different combat arms together in one concerted effort. Certainly there were problems -- communication breakdowns, for example, continued to slow the transmission of news, while the immobility of some units slowed the assault -- but overall the attack was, at least throughout most of the first and decisive day, well coordinated. C.P. Stacey came to this conclusion as well, writing: "In spite of the inadequate training of the cavalry for action with tanks, Amiens is an outstanding example of *Co-operation* -- between infantry, tanks and artillery, and between the ground forces and the air."⁶² Commanders were generally well in touch with events, and so could call on support when needed. When that support was not forthcoming it was generally due to problems in maintaining mobility and communications, and not with intelligence collection *per se*. This is not to argue that intelligence won the battle single-handed. The tactical skill of the men asked to fight over ground unknown to them, and with little warning, must be given due

⁶² C.P. Stacey, "The Battle of Amiens 1918," *Canadian Army Journal* 4.8 (January 1951), 10. This is also the conclusion of Ian Brown in his more recent article "Not Glamorous, But Effective," 436. He writes that "All-arms cooperation worked as well at Amiens as it had for the Australians at Hamel;" a battle recognized for its all-arms cooperation. Tim Travers credits the "dazzling success...to the *élan* of the Canadian infantry" and to the severity of the set-piece assault, claiming in the process that "the essential mobile firepower support of trench mortars, machine guns, field artillery and tanks, without which an advance cannot be sustained, was missing." This last point is, I believe, too harsh a judgment, as some mobile firepower was available; although his point about the importance of the set-piece assault is undeniable. Travers, *How the War was Won*, 121 - 122. Another example of all-arms cooperation can be found in the "4th Canadian Division Narrative of Operations, Battle of Amiens. August 8th to August 13th, 1918." There we read: "The enemy had a very strong Machine gun Defence organized in the woods...[This] opposition was overcome by the successful employment of the combined action of one Infantry Company of the 78th Battalion, an 18 pdr. Battery, 4 or 5 Tanks and a 6 [inch] Trench Mortar, resulting in many casualties to the enemy, the capture of 20 prisoners and 12 Machine guns." See R.G. 9 III B1, Vol. 2276, Folder 0-2-30, Vol. 1.

credit, as should the value of the training the men received earlier in the summer. The skill of the gunners, the tank crews, and the RAF pilots cannot be discounted either. The terrain was also an important factor in the victory. The fact that the ground was relatively free of trenches and other defensive obstacles meant that ground troops, and advancing tanks and artillery, did not have to slog their way forward as in earlier battles when powerful defensive works blocked their paths. Indeed, when the Canadians reached the old Somme battlefields the battle ground to a halt. Still, Amiens proved an enormous victory, and a turning point in the war, for from that point on, the Allies were on the offensive.

The remaining battles of the 100 Days followed a similar pattern to that established at Amiens. They were massive set-piece assaults, launched after short periods of intensive planning and study. Since the fighting was, for the most part, mobile in nature, the Canadians continued to place great reliance on intelligence collected while the action raged. This was especially important for coordinating the advance of the various combat arms, and for securing the locations of previously hidden hostile batteries and strong points. Due to the rapidity which the Canadians launched their assaults, less was known with certainty about the German lines than the Canadians would have liked. Improved communication flow, thanks to experience in the use of report centres, FOOs, LOs, and the RAF, lessened the need for such details, however, for it helped get target information through to those who could use it.

Intelligence work, then, remained a vital component in the corps' success during the 100 Days. The commander of the 1st Brigade, when discussing his brigade's part in the crossing of the Canal du Nord (September twenty-seventh), had this to say about the value of intelligence work to the brigade's victorious advance. Prior to the attack

The first task was reconnaissance, firstly for assembly areas, secondly of the Canal crossings and thirdly of the area to be traversed in the attack. The value of time spent on work of this nature is unquestionable and as the days passed an astonishing quantity of valuable information was secured and I think that the smooth working of all plans and arrangements during the attack is attributable to the work done during the preparation period. O.P.s. were selected and manned and the area of attack kept under constant observation. Scouts and patrols familiarized themselves with the ground...The officers of...Battalions thoroughly reconnoitred the whole area. Maps and photographs were secured, read and corrected. Close liaison was established and kept with troops in the line and all ranks were lectured and instructed with maps and photographs and by exercises in the tasks they were required to perform.⁶³

The 3rd Battalion noted after this same battle that the pre-battle intelligence

was of the greatest assistance, especially the reports from our Intelligence Section, who had reconnoitred the whole area between the original front line and the Canal du Nord. Every Company Commander had personally reconnoitred the route he would take his company over to the canal.

Of great help during the battle was the map supply which "Could not have been better. Every Officer and Platoon Sergeant had a marked map showing boundaries and objectives for the attack."⁶⁴ The 2nd Battalion simply said that the intelligence available prior to the advance "was invaluable."⁶⁵

Similarly, pre-battle intelligence remained crucial for planning artillery actions. Fire programs depended on the intelligence collected concerning German defensive layouts, gun emplacement locations, and other tactical features. The barrage plans for breaking the D-Q Line (September second), the crossing of the

⁶³ NAC, R.G. 9 III C3, Vol. 4028, Folder 15, File 5. 1st Brigade report on the Crossing of the Canal du Nord, October 5, 1918; also in Vol. 4016, Folder 32, File 3, and M.G. 30 E15 (Griesbach Papers) Vol. 5, File 33(A).

⁶⁴ NAC, R.G. 9 III C3, Vol. 4028, Folder 15, File 5. 3rd Battalion to 1st Brigade, October 6, 1918.

⁶⁵ NAC, R.G. 9 III C3, Vol. 4028, Folder 15, File 5. 2nd Battalion to 1st Brigade, October 1, 1918; see also Folder 16, File 3. 2nd Battalion report to 1st Brigade, October 1918 for similar comments on some later fighting.

Canal du Nord and the capture of Mount Houy/Valenciennes (November first), with their precisely timed bombardments that saw shells criss-cross the front, and double back over previously shelled areas were, thanks to thorough intelligence work, wondrous in their conception and application, and took a terrible toll on the German defenders.

Effective counter battery fire was also dependent on intelligence. Enemy batteries were saturated with shells, knocking them out of action at critical moments during the infantry's advance. Counter battery fire was normally so good during the 100 Days that the Germans were forced to be extra vigilant when concealing their batteries. When recounting its role at the Canal du Nord and Bourlon Wood (September twenty-seventh), the Counter Battery Office said

it was evident from prisoners' statements, captured documents and [other] counter battery sources of intelligence that the enemy was employing every means to avoid betraying his main battery positions so that in the event of an attack by us our neutralizing fire would not reduce the intensity or completeness of his barrage...There were undoubtedly many batteries registered and kept silent...and prisoners stated that there were guns in reserve with positions ready for immediate occupation. This was confirmed by our intelligence....

Also,

a considerable number of newly constructed positions were revealed by aeroplane photographs. The photographs...also indicated a tendency on the part of the enemy to place the pits of his batteries farther apart than formerly, evidently to minimise the effect of neutralizing fire.

Indeed, pre-battle counter battery intelligence was excellent during this operation. "In order to make certain that at least all known and suspected hostile batteries were neutralized it was found that 113 positions had to be covered [by counter battery fire]." Knowing that some of these 113 positions would be vacant on Zero Day, the Counter Battery Office relied on the services of the corps squadron to inform the gunners as to which pits were actually active during the assault. This allowed the

heavy batteries to save ammunition, and to concentrate on targets where active enemy batteries really were situated. After the battle the CBO concluded, rather unassumingly, that "Apparently the appreciation of the hostile artillery situation had been substantially correct for there were only six batteries active in positions which had not been included in the neutralization scheme." In effect, nearly every German gun had been located prior to Zero Hour.⁶⁶ Such precision planning, as has been argued throughout this study, made success all the easier.

The all-arms, deep-penetration battle also consumed a great deal of intelligence while the action raged. Intelligence sections manned OPs, carried out reconnaissances, and established forward observation posts and report centres. From these posts they endeavoured to maintain touch with the enemy and monitor their actions. In early September, for example, the 2nd Brigade recorded how a scout working from one of these advanced parties "made a daring and valuable reconnaissance under heavy Shell and Machine Gun fire, and succeeded in locating two enemy Machine Gun nests which were causing a deal of trouble." As a result of this information the infantry organized flanking parties and captured the nests along with fifteen prisoners.⁶⁷ In the 1st Division's report on the crossing of the Canal du Nord we find in a section concerning the use of machine guns the claim that "An O.P. from which the progress of the advance can be clearly seen offers the best solution of the problem of how, when, and where to apply fire to advantage

⁶⁶ NAC, R.G. 9 III C1, Vol. 3923, Folder 11, File 5. Counter Battery Office report on Battle of Bourlon Wood, September 27, 1918. An added reason for having reliable counter battery intelligence at the Canal du Nord was in the fact that the Canadians packed their narrow front with troops while waiting for Zero Hour. If the Germans had started shelling, the counter batteries were responsible for silencing the German guns in order to protect the infantry.

⁶⁷ NAC, R.G. 9 III C3, Vol. 4016, Folder 31, File 2. "2nd Canadian Infantry Brigade Narrative of Operations East of Arras August 25th to September 3rd 1918."

and of obtaining constant and early information of the situation.”⁶⁸ This same idea applied to all units and supporting arms, and allowed commanders to keep in touch with events.

After Amiens, tanks played a diminishing role in Canadian operations due to their scarcity. Still, the actions of those tanks that took part in Canadian assaults required coordination with the infantry. Much of that coordination, of course, came in the planning stages when they received their orders. Once the action started the tanks maintained touch through their unit commanders stationed at the infantry headquarters the tanks were supporting. Lessons learned at Amiens also saw the infantry advancing in front of the tanks, and reconnoitring the ground for them. As the First Army said at a conference at the end of August: “To permit tanks to advance without proper reconnaissance will render them an easy prey to the enemy’s guns.” The infantry were to take out any anti-tank guns along the way, and call on the tanks only when they required help, at which time the tanks came forward to crush any machine guns or pockets of resistance holding up the advance. Simple signals, and the close proximity of the tanks to the infantry, helped maintain the necessary close cooperation.⁶⁹

However, there is no denying the fact that most of the intelligence effort that occurred before and during battle concerned the needs of the artillery. McNaughton wrote after the war that “the whole of our intelligence system was centred on those who had the means at their disposal to take immediate and effective action.”⁷⁰ Those with “the means at their disposal” were the gunners who, for the most part,

⁶⁸ NAC, M.G. 30 E60 (Matthews Papers) Vol. 6, Folder 23. “1st Canadian Division Report on Canal du Nord, Bourslon Wood and Cambrai Operations Sept. 27th -- Oct. 2nd Inclusive 1918.”

⁶⁹ NAC, R.G. 9 III C3, Vol. 4210, Folder 1, File 3. “Lessons From Recent Fighting Referred to by the Army Commander at Conference Held at Canadian Corps Headquarters 30th August, 1918.”

⁷⁰ A.G.L. McNaughton, “Development of Artillery in the Great War,” *Canadian Defence Quarterly* 4 (1929): 160 - 171.

were under corps and divisional control.⁷¹ Since the artillery could break up massing enemy troops preparing for counter attacks, disrupt the arrival of enemy reinforcements, ammunition, and food supplies, silence and harass enemy guns, and eliminate obstacles and pernicious pockets of enemy troops and machine gun nests, it was the arm that could most readily effect the course of battle, and was most needful of up-to-date intelligence. Reliable communications were obviously vital, but so were the men and special teams gathering the information in the first place, and monitoring the progress of the advance. Their efforts bestowed enormous freedom of action on to corps, divisional and artillery officers, who now had sufficient information for taking advantage of opportunities to inflict damage on enemy troops and positions. As a consequence, artillery action dominated planning and operations, ensuring that artillery intelligence work remained a vibrant and pivotal activity. The successful break up of counter attacks, for example, was a direct result of either careful study of pre-battle intelligence regarding normal German routes of approach, billeting areas and likely assembly areas, or of word reaching the gunners during an attack that German troops were seen massing at some point.⁷² In both cases, German troops suffered. At Valenciennes and, indeed, throughout the 100 Days, "Great importance was attached to the harassing of all important routes of approach, sunken roads and valleys," and "In order to give the infantry every possible assistance at what was expected to be critical parts of the battle, proposed assembly areas of the enemy were subjected to timed concentrations from the counter battery artillery." A post battle review of the

⁷¹ The corps retained control of most of the guns throughout the set-piece phase of assaults, with control reverting to divisions once the consolidation phase began.

⁷² A.G.L. McNaughton, "The Capture of Valenciennes: A Study in Co-ordination," *Canadian Defence Quarterly* 10.3 (April 1933): 286, 291; G.W.L. Nicholson, *The Gunners of Canada. A History of the Royal Regiment of Canadian Artillery, Vol. 1 1534 - 1919*, (Toronto: McClelland & Stewart, 1967), 369.

artillery's part at Valenciennes "showed that very valuable results had been obtained. The enemy's supplies of ammunition and reinforcements being evidently greatly interfered with. The casualties to the enemy's transport were particularly high in the sunken roads...In some cases the road was practically blocked by the destroyed wagons and dead animals."⁷³

A further sign of the artillery's dominance during the 100 Days was the transformation of the Counter Battery Office into the corps' principle intelligence report centre. Since the disposition of enemy guns revealed so much about the enemy's capabilities and intentions, and since the CBO was privy to, and accumulated all such information, this was a natural occurrence. Aerial observers, balloonists, the Canadian Corps Survey Section, artillery and other ground observers, and sound rangers all submitted reports to the CBO for collation. As a result, the CBO was almost always aware of events transpiring along the front; and because it was in continuous communication with corps headquarters, corps command was usually fully in-tune with events as well. The CBO described its intelligence role as follows: "It has been accepted that during Moving Warfare a 'Corps Advanced Report Centre' is necessary. The Counter Battery Office is the logical place at which this Report Centre should be situated, for the majority of the sources of Intelligence and of the means of taking action on that Intelligence, are already centred on the C.B.S.O." Effective communications, of course, were necessary for tying the entire matrix together, which was why the CBO was well supplied with wireless, telephones, despatch riders and other methods of transmitting and receiving news. Such near complete knowledge of the front gave the corps, the artillery, and even divisional commanders enormous flexibility. Unlike earlier in the war, in 1918 these commanders were normally well informed

⁷³ NAC, M.G. 30 E157 (Crerar Papers) Vol. 22, Folder 3. Counter Battery Office "Notes on Counter Battery Support in Capture of Mont Houy By the Canadian Corps on the 1st. November 1918," prepared February 3, 1919.

as to where and when the infantry were stalled, could command the artillery to eliminate points of resistance, could call on the RAF for news, could send forward reserves at the appropriate time and place, and do so as effectively as if they themselves were watching events first hand.⁷⁴

Due to the speed with which pilots could deliver news to the gunners, the importance of the corps squadron as a source of counter battery intelligence continued to expand during the 100 Days. Intelligence gathered by the corps squadron allowed the artillery to constantly harass German troops and batteries. One Counter Battery Office memorandum said:

In the moving [battle] the aeroplane forms the greatest source of intelligence. Its advantage being that reliable information regarding the disposition and movement of enemy troops and the strength and grouping of the Hostile Artillery can be quickly delivered to the General Staff. Experience has shown that by establishing dropping stations well forward much unnecessary delay may be prevented.⁷⁵

According to Lieutenant Colonel H.D.G. Crerar, who was the CBSO during the last weeks of the war, the corps squadron was “very often the only reliable source of information” on the location of hostile batteries, and that “the effective neutralizing of hostile artillery fire at critical moments may depend almost entirely upon the work of the Corps Squadron.”⁷⁶ After breaking the D-Q Line on September second, most of the counter battery intelligence reaching the CBO came through the squadron’s efforts, with “two or three results” obtained by the Canadian Corps Survey Section.⁷⁷ Similarly, at Valenciennes “special importance”

⁷⁴ NAC, R.G. 9 III C1, Vol. 3922, Folder 7, File 4. Report on the workings of the counter battery office, November 21, 1918; also File 9. Counter battery office to the heavy artillery, December 9, 1918.

⁷⁵ NAC, R.G. 9 III C1, Vol. 3922, Folder 7, File 4. Counter battery office to Canadian Corps Heavy Artillery, November 21, 1918.

⁷⁶ NAC, R.G. 24, Vol. 1832, Folder GAQ. 8-15e. “Organization and Procedure of Counter Battery Office Canadian Corps Artillery,” January 25, 1919.

⁷⁷ NAC, R.G. 9 III C1, Vol. 3923, Folder 12, File 5. “General Staff Report for Period 6.00 a.m. 30th August to 6.00 a.m. 6th Sept.,” September 6, 1918.

was attached to the corps squadron's role in locating hostile batteries on the day of battle. At that battle the Germans employed "roving batteries" that moved across the front as needed. These were difficult to locate by ground level means, so aerial observers played a crucial role in finding them through direct observation. Aerial photography was useless for tracking such guns, as the Germans did not dig pits for them, or keep them long in one spot. During the battle aerial observers were therefore called upon to locate all those German guns that "had been impossible to locate definitely prior to zero hour on account of their having either remained silent or been deployed in new positions." A CBO after action report declared that

On the whole the results obtained [by the corps squadron] were most gratifying...Evidence from all sources substantiates the fact that [German artillery] shelling at zero and throughout the day was in no way a menace to the advance of our infantry...A great deal of the neutralization programme for the day must be attributed to the pilots and observers of No. 5 Squadron.

So effective were the pilots at Valenciennes that "it was possible to follow the enemy's artillery manoeuvres throughout the day."⁷⁸ Finding German anti-tank guns proved more difficult, although the RAF did hunt for them, and notified the artillery of their location. Other times the pilots engaged the anti-tanks guns themselves, often at considerable personal risk.⁷⁹

The CBO also helped keep RAF Bombing Squadrons informed of potential targets throughout the 100 Days. At Valenciennes, for example,

Important targets, such as large bodies of enemy infantry, artillery on the move, convoys of motor transport, which were either beyond the effective range of the artillery, or which, by reason of their extreme importance required a very tense bombardment, were

⁷⁸ NAC, M.G. 30 E157 (Crerar papers) Vol. 22, Folder 3. "Notes on Counter Battery Support in Capture of Mont Houy by the Canadian Corps on the 1st. November 1918," February 3, 1919.

⁷⁹ NAC, M.G. 30 E60 (Matthews Papers) Vol. 7, File 25. "Notes From the Battle 21st/23rd Aug., 1918."

engaged by the Army Bombing Squadron in response to...calls sent from the Counter Battery Office by wireless or telephone to the H.Q. [IX] Brigade R.A.F.

The Canadians were very pleased with the results of this arrangement, stating that "The close liaison between the Bombing Squadrons and the Counter Battery Office during a battle is considered to be of the very greatest importance."⁸⁰

The Canadian Corps Survey Section was employed extensively throughout the 100 Days, giving corps headquarters another direct channel to events at the front. During those periods when trench-like conditions prevailed, the flash spotting teams kept busy searching for enemy batteries, while the scouts, observing from corps OPs, explored the reaches of the German back area for clues on the enemy's next move. During assaults, and especially during the more extensive German withdrawals in late October, the artillery observation section (the flash spotters) combined forces with the intelligence observation section (the corps observers) to form "extra strongly manned observation posts."⁸¹ Typically there were three such posts in operation at any one time, and each post was divided into two teams. One team, composed of eight scouts from the intelligence observation section worked well out in front of their respective home post, and in close proximity to the foremost advancing infantry. They had specific areas to reconnoitre based on map squares, and collected information from the advancing infantry and through personal observation. They made about three tours of the front each day on these fact finding missions. To ensure cooperation from officers in the forward-most units, and to prevent their being arrested as spies, they carried "passes and letters" addressed "to Brigade and Battalion Commanders requesting

⁸⁰ NAC, R.G. 9 III B1, Vol. 969, Folder 0-22-3 (Vol. 1). "Artillery Report on Mont Houy (Valenciennes) Operation By Canadian Corps Nov. 1st, 1918."

⁸¹ NAC, R.G. 9 III C1, Vol. 3920, Folder 2, File 2. Counter Battery Office to War Narrative Section, Canadian Corps, February 3, 1919.

that they be furnished with any information bearing on the tactical situation.”⁸² There were occasions, according to both Captain Flewin, the CCSS’s commander, and the CBSO, when these scouts actually worked in front of the advancing infantry in a way reminiscent of pre-war scouting. These forward scout teams sent back a constant stream of news to their particular post, which in turn relayed the news via wireless to the CBO and others so “that all concerned were as far as possible continuously au fait with the situation on the Corps front.”⁸³ A number of German-speaking scouts accompanied these forward adventurers in order to obtain quick identifications and other tactical details from captured Germans. Following behind these scouts, or as part of its team, were special details of men charged with searching all captured dugouts, enemy battery positions and so forth, “for documents and maps which were sent back to Corps P.O.W. [holding] Cages for examination.” Meanwhile, the personnel from the artillery observation section (flash spotters) remained at the posts and concentrated on locating hostile batteries and watching for enemy ground movement.⁸⁴ Overall, the CCSS was highly regarded, as it fed corps command and the CBO reliable information in a timely way. Indeed, during the German withdrawal on Valenciennes the CCSS was reportedly “one of the very few means of communication of Intelligence” available to the corps, as its organization was capable of quickly relaying news thanks to its heavy use of wireless and telephones. It was especially useful when weather grounded the RAF. In fact, the CCSS was kept so busy during the 100 Days that its original establishment was found to be too small. In October, Captain Flewin

⁸² NAC, R.G. 9 III C1, Vol. 3922, Folder 7, File 4. Counter battery office to Canadian Corps Heavy Artillery, November 21, 1918.

⁸³ NAC, R.G. 9 III C1, Vol. 3920, Folder 2, File 2. Counter Battery Office to War Narrative Section, Canadian Corps, February 3, 1919.

⁸⁴ NAC, R.G. 9 III D1, Vol. 4711, Folder 98, File 9. “History of the Canadian Corps Survey Section,” by Captain Flewin, April 1919. Flewin writes that the use of wireless for relaying intelligence was “copied by other corps who secured the services of groups of Lovats’ Scouts or other similar units.”

requested an increase of forty-four men along with the necessary accoutrements. Apart from its value to intelligence collection and transmission, the CCSS's map producing capability was of enormous utility, and helped disseminate the latest intelligence to all map recipients in a timely fashion. Some officers estimated that the Canadian Corps received its specialty maps two days to a week in advance of other corps forced to rely on overworked army presses for theirs.⁸⁵ This was of enormous benefit to the corps, for during the last weeks of the war it regularly operated over relatively unknown ground. The Canadians advanced so quickly during the final stages of the war that at Valenciennes they actually outran their supply of modern maps, and had to content themselves with nineteenth century French maps. To make them useful to the gunners the CCSS laid a modern map grid on them.⁸⁶

During the pursuit of the retreating German Army from about mid October to the Armistice, intelligence gatherers faced entirely new circumstances: moving warfare. Aircraft played an important, and perhaps dominant, role during this phase of the war. They tried to locate the new positions held by the Germans after the Germans broke off contact with the Canadians. This was not always an easy task considering the Germans "retired so fast that it was a constant difficulty to keep track of their movements." On some occasions the only way for pilots to discover the whereabouts of the new German line was to fly low and intentionally draw fire, said one report.⁸⁷ On the ground the corps used a form of advanced guard as in

⁸⁵ NAC, R.G. 9 III C1, Vol. 3922, Folder 7, File 6. Canadian Corps Survey Section to CBSO, October 14 and 26, 1918; R.G. 9 III B1, Vol. 2279, Folder 0-2-30 (Vol. 21). "Counter Battery Office, Canadian Corps Artillery, Order No. 82," September 25, 1918; M.G. 30 E 5 (Bovey Papers) Vol. 2, Folder 10. "Report on Wireless Communication During the Operations at Arras, Aug. 26th - Sept. 10th. 1918," October 5, 1918.

⁸⁶ Nicholson, *Gunners*, 368.

⁸⁷ NAC, R.G. 24, Vol. 1839, Folder: GAQ 10-20. "No. 5 Squadron Work Under Command of Major C.H. Gardner From July 1918 to November 11th 1918," January 1, 1919

pre-war days. Each day the leading units and formations threw out advanced parties to locate the whereabouts of the enemy's new position. They were often joined by scouts from the CCSS who also toured the front throughout the day in search of news. The 1st Brigade reported that

During the recent operations which were practically open warfare the whole of the intelligence personnel were employed as scouts [i.e. out in front]. The rapidity of the advance and the nature of the ground rendered observation posts worthless. The Battalion Scouts under the Scout Officer preceded the Companies until touch was established with the enemy, whereupon they were used to maintain touch between the line Companies and the Battalions on the right and left. A small number of the personnel being left at Battalion H.Q. for special reconnaissance when required by the C[ommanding] O[fficer].⁸⁸

Elements from the corps cavalry and the Canadian Corps Cyclist Battalion made an appearance at the front too. Each forward battalion had attached to it a cavalry section of one NCO and six men, plus a platoon of cyclists. "The work of the Cavalry was good on the whole," said one summary, and "sent in valuable reports." Similarly, the cyclists did "good work in keeping touch with the enemy and in carrying despatches." The cyclists' usefulness, however, was limited by the fact that they needed good roads.⁸⁹ The 72nd Battalion was very pleased with the work of the cyclists and cavalry attached to it, writing that their work during "recent operations cannot be too highly spoken of, and their services in reconnoitring cross roads and tactical points was of immense value...Their reports turned over to

⁸⁸ NAC, R.G 9 III C3, Vol. 4025, Folder 7, File 4. 1st Brigade to 1st Division, October 25, 1918.

⁸⁹ NAC, R.G. 9 III C3, Vol. 4053, Folder 24, File 16. "Summary of Important Points, (Not Specially Emphasized in Reports on Previous Operations), Brought Out During the Advance From the Trinquis and Sensee Rivers, Between October 11th and 22nd 1918," 1st Division, November 6, 1918. Reference to advanced guards is also made in Vol. 4210, Folder 1, File 3. "Lessons From Recent Fighting Referred to By the Army Commander at Conference Held at Canadian Corps Headquarters 30th August, 1918." At that date, reference was made to the improper use of advanced guards by some formations. Officers, not surprisingly, were still thinking about trench warfare.

[battalion headquarters] during the operations were concise and accurate.” Cyclists were best when fresh, and the battalion commander recommended they not be used where infantry patrols could do the work just as well. The mounted troops from the Canadian Light Horse attached to the battalion, on the other hand, were used only to carry messages and not for reconnaissance purposes.⁹⁰ Forward brigades, likewise, were apportioned their own share of cavalry and cyclists for similar purposes.⁹¹

The “greatest difficulty” faced by the Canadians during the German retreat, according to the 1st Brigade, was maintaining communication over such vast distances. The brigade wrote:

The most reliable means is by mounted orderly. A very satisfactory arrangement in some cases was made by the Scout Officer advancing in the centre of the Battalion front about in line with the front Companies. He laid a line as he went and the Scouts brought information to him and he phoned it to Battalion Advanced H.Q. This wire was then picked up [by commands following in the rear] as the Battalion advanced.⁹²

In effect, a portable telephone system was maintained as the corps moved forward. The difficulty with this system lay with securing lateral communications, as cables were not strung in these directions during the advance. As well, advancing tanks, artillery and cavalry continuously ran over the lines, breaking them in the process. It also required a lot of cable, and in order to limit the demand, the 1st Division advised all commands to use the cable left lying on the ground by the retreating

⁹⁰ NAC, R.G. 9 III C3, Vol. 4238, Folder 6, File 1. “72nd Canadian Infantry Battalion Seaforth Highlanders of Canada Report on Operations October 22nd to November 6th, 1918,” dated November 11, 1918.

⁹¹ NAC, R.G. 9 III C3, Vol. 4053, Folder 24, File 16. “Summary of Important Points, (Not Specifically Emphasized in Reports on Previous Operations), Brought Out During the Advance From the Trinquis and Sensee Rivers, Between October 11th and 22nd 1918,” November 6, 1918.

⁹² NAC, R.G. 9 III C3, Vol. 4025, Folder 7, File 4. 1st Brigade to 1st Division, October 25, 1918.

enemy, and to perfect alternative means of communication (runners, cyclists, and mounted orderlies, for example). To reduce the amount of cable further, and to lessen the difficulties of communicating over large distances, the 1st Division recommended that battalions locate their headquarters in the centre of their front when brigades were advancing with one battalion forward. If advancing on a two battalion front, each battalion was to place its headquarters in the rear of its inner flank. "Lateral communication is thus reduced to a minimum, and the difficulty of finding Battalion Headquarters wholly [eliminated], since signal personnel, detailed and equipped for the purpose, work from Battalion Headquarters to the central line of communication."⁹³

According to Currie, during the final three months of war the intelligence service possessed greater "elasticity than hitherto" and was "adaptable to conditions as they arose."⁹⁴ This allowed it to continue to amass an incredible amount of information on short notice and over long distances. As a result, the Canadian Corps was continuously supplied with vital information for making plans and preparing movements. Intelligence was certainly not the only contributing factor to the corps' ability to win battles, but it was indispensable to the Canadian way of war -- a way of war that began to materialize after the pounding the Canadians received at Second Ypres back in April 1915.

⁹³ NAC, R.G. 9 III C3, Vol. 4053, Folder 24, File 16. "Summary of Important Points, (Not Specifically Emphasized in Reports on Previous Operations), Brought Out During the Advance From the Trinquis and Sensee Rivers, Between October 11th and 22nd 1918," November 6, 1918.

⁹⁴ Arthur Currie, "Historical Resume of Canadian Corps Intelligence," in J.E. Hahn, *The Intelligence Service Within the Canadian Corps, 1914 - 1918* (Toronto: The Macmillan Company of Canada, Limited, 1930), xxi.

A RETROSPECT

The Canadians entered the First World War without a well developed or defined intelligence service. The prewar Corps of Guides certainly encouraged the Canadians to think about field intelligence, but what little thought they gave it concerned its acquisition and use during a war of movement. Intelligence training reflected this concern. Trench warfare, with its need for detailed planning and massive intelligence effort, was unexpected. The Canadians, in other words, were entirely unprepared for trench warfare as it existed on the Western Front. Thanks to their British instructors, and through the hard hand of war, however, the Canadians learned the intelligence skills and other battle-winning techniques necessary for defeating the highly skilled German Army. It was an extraordinary accomplishment for what were largely volunteer and amateur soldiers. Yet without this sea-change in their tactical and intelligence abilities it seems unlikely that the Canadians could have achieved the victories they did.

When the Canadians first entered the lines in February and March 1915, their attitudes towards intelligence had not changed appreciably from their prewar position. They, like most everyone else, expected a resumption of open warfare after the next big push achieved a breakthrough. It was only after their near defeat at Second Ypres in April 1915 that the Canadians began taking a hard look at their intelligence organization. Second Ypres had rattled the Canadians, and convinced them that the Germans could not be taken lightly. The great lesson they learned at Second Ypres was that they were not prepared to meet, let alone defeat, an enemy as resolute and wily as the Germans. And although contemporaries did not admit

it, the battle was a near disaster, and not a shining victory; the Canadians were lucky to hold on to the extent that they did until reinforcements arrived. Most commands lost control of the situation at one point or another for a lack of information. The Canadians proved, though, that they were tenacious fighters when on the ropes; however, being punched when backed into a corner was not the way to win the war; nor was relying on lady luck to intervene a very secure approach to battle. To win, the Canadians had to remain in control of themselves and the situation, and eliminate as much luck and chance from the field as possible. And that is what they set out to do by becoming fully informed.

At Festubert and Givenchy, Canadian brigades sought delays when their understanding of the front was deficient in some way. At the time, however, they did not possess the requisite prestige and experience to challenge larger plans set by higher commands, and proceeded as ordered. The fact that Currie could not even identify his objective at Festubert simply reinforced in his mind the folly of attacking when unprepared. Such recklessness only encouraged ill-fortune. At Givenchy the Canadians received the necessary time to collect and study intelligence on the enemy position, and the near success that attended that operation encouraged greater use of intelligence in the future; thorough planning seemed an obvious key to success.

In order to secure the details now required, however, the intelligence system needed a major overhaul. Up until Givenchy, intelligence collection had been a rather haphazard affair, with companies and others collecting what information they could. At that time the Canadians simply lacked the necessary intelligence organization for carrying out a systematic surveillance of the front. There were no battalion-level intelligence sections, for example, while brigade staff captains(I) were without staff, and controlled no independent sources of news. Things were marginally better at divisional headquarters, but only because the divisional

intelligence officer had the use of a pool of clerks. Like his brigade counterparts, though, he controlled no independent means for gathering information. Beginning in August 1915, however, and continuing until about May 1916, battalions began forming intelligence sections composed of scout specialists and headed by an officer dedicated to battlefield intelligence work. Brigades formed their own intelligence organization at this time too, and from then on intelligence collection improved and expanded.

With these beginnings the Canadians altered how they went about collecting news. Rather than haphazardly patrolling no man's land, or waiting passively in the trenches or in listening posts for intelligence to come to them, they began making aggressive forays into no man's land to secure the information they wanted. The domination of no man's land, through bold and well organized patrolling, became standard Canadian fare from late 1915 onwards. By controlling no man's land they could amass a tremendous amount of information of a local, tactical nature that, when compiled and compared to that collected across the front, told the Canadian command a great deal about the Germans and their defences. It was in this enhanced intelligence environment that the Canadian Corps organized its first trench raid. The Canadians, wanting to know what lay behind the German wire, decided to go and take a look. Paul Villiers, an officer in the 3rd Brigade at the time, when writing in his diary-memoir, had this to say about the decision to make that first raid:

Curiosity as to what lay beyond [no man's land], grew. The Bgder (Brigadier Gen A.W. Currie) used to examine his patrols reports every morning, and one old scout suggested that it was his belief that the Bosch [Germans] had either given up that part of the line owing to the wet, or were holding it very lightly. Any way 'he would like to get across and see.' They [the brigade officers] all

looked at him in amazement, then at one another, and said 'Why Not'['?'] And a scheme was drawn up.¹

Such aggressiveness and the need to know drove the Canadian intelligence service onwards. Interestingly, raids for the purpose of gaining information devoured a great deal of intelligence themselves in their planning stages, reflecting the corps' desire to prepare thoroughly for all operations no matter how small.

By the time the Canadians next saw significant fighting, in April 1916, battalions and brigades had their own intelligence sections in place. Unfortunately, some commands were still too inexperienced in their use, and at St. Eloi failed to extract the maximum benefit from them. Absentee intelligence officers had not been replaced, and scouts, exhausted from carrying out both scouting and non-scouting duties, provided little concrete information. When combined with the abominable conditions the Canadians faced and the fact that most of the men were facing their first major test under fire, their poor showing is not surprising. Without reliable communications and a well adjusted intelligence organization, rear area commanders were left in the dark about events at the front, and had no idea where their troops were located.

At Mount Sorrel, once the Canadians recovered from their initial defeat, intelligence work began to improve. Planning for the counter attack on June thirteenth was intense, and based on a thorough appreciation of the available intelligence. Artillery blasted the Germans out of their trenches, which allowed the

¹ NAC, M.G. 30 E236 (Villiers Papers) Vol. 4. Diary entry November 17, 1915. I suspect that this diary was corrected after the war, and is more of a memoir. For example, Villiers wrote on occasion: "I remember how . . .", people who write diaries don't tend to say "I remember," they just write down what happened. Also, with this particular quotation, Villiers names the wrong brigadier. Currie was in command of the 2nd Brigade at one point, but by the time of the November raid Currie had moved on to command the 1st Division. The 2nd Brigade was then under Brigadier Lipsett. The general line of Villiers' story is probably correct; the 'old scout's' desire to go see what lay beyond sounds like something a scout would want to do. Neither did he embellish the story or supply the scout's name, and this, I think, lends credence to his entry.

Canadians to retake the ground lost two weeks earlier. But at Mount Sorrel, and later at the Somme, enemy guns proved the main killer of troops, and stopper of assaults. Intelligence and gunnery techniques were simply inadequate at this time when it came to silencing enemy batteries. By the time the Somme had ended, though, sound ranging, aerial reconnaissance, and flash spotting had evolved to such a state of proficiency that hostile batteries could be found and targeted. This ushered in a new phase in the intelligence war, as counter battery fire and artillery work came to dominate planning. This represented a major shift for intelligence work, as the needs of the gunners now had to be considered far more than previously, for the artillery was now the dominant arm. To aid the artillery intelligence effort, and to increase the flexibility of artillery action, the Counter Battery Office was created. This office received nearly every scrap of information collected across the front, compiled it, stored it, and studied it in order to find ways of defeating the enemy's guns. It was also closely tied to corps headquarters, thereby increasing the agility of that command's response to events at the front.

The Canadians used artillery profusely in each of the actions it waged in 1917: Vimy Ridge, Hill 70, and Passchendaele. At Vimy, for example, the artillery put to use finely tuned plans, timed to the minute. Every German trench, every known hostile battery, and every known strong point, forming up point, route of approach, observation post, and command centre was targeted for elimination or neutralization. The infantry conformed to the artillery's plan, and the whole arranged to such a degree of precision that luck played little part in the action, while chaos was reduced to a manageable measure, as the movement of both guns and men were predetermined. Chaos reined amongst the German defenders, however, encouraged by the hail of steel pounding their positions into pulp. Intelligence was vital to this battle winning prescription, for nearly all movements and decisions were pre-calculated. As such, the intelligence war during 1917 was

monumental, even when compared to the Canadian counter attack at Mount Sorrel in 1916. Battles were planned over weeks and months. Study and more study was the hallmark of Canadian actions. At Passchendaele, teams of Canadians visited and lived with the commands they were to replace in the lines weeks in advance of the scheduled relief in order to become as familiar as possible with the current situation. So in tune were the Canadians at the time of the relief that when the main body of troops arrived they knew exactly what they were getting into. There would be no more St. Eloi fiascoes facing the corps if the Canadians could help it.

Once battles opened up in 1918, the Canadian battle winning formula required some adjustments. These they got down to making once the initial threat of a German offensive against them passed. Training for the day when they would attack was intensive, as the Canadians rehearsed the requirements of the all-arms, open, mobile battle. With such battles even greater flexibility was called for, as the fluidity of German defences made them harder to pin down. Precision planning, while still the ideal, became less rigid. And while the Canadians still amassed mountains of information in the days prior to an attack, the depth of the defence, and the limited time available in which to amass intelligence, ensured that more of the German defences were unknown on the day of advance than was the case during static trench warfare. This, however, was no longer seen as the insurmountable problem it had been in earlier years. The Canadians were confident that they would find any undisclosed enemy batteries once actions were underway, thanks to the efforts of the RAF, FOOs and other ground observers. Improved gunnery technique guaranteed that they were quickly silenced. Meanwhile, unanticipated difficulties facing the infantry in the form of previously undisclosed German machine guns and other strong points were smashed by the rolling barrage. Failing this, improved tactics, based on the principles of fire and movement, encouraged the men on the ground to press home the attack and solve problems for

themselves if support was not immediately available from nearby tanks, machine guns, or mortars. Throughout each action of the 100 Days, intelligence specialists worked to keep commanders informed of events at the front in order that they might fine-tune the bombardments, take advantage of targets of opportunity, and commit their reserves at opportune times. Again, flexibility was vital, and it was intelligence that greased the wheels of command. By the time the war ended, the intelligence system could and did switch back and forth between static and open warfare with relative ease, and allowed the corps to function under either circumstance. Corps momentum during the final advance was maintained, at least in part, because corps command was almost always aware of events along its front. The Canadian Corps, thanks to its intelligence organization, was never in the dark for long.

Appendix One¹

Senior Corps Intelligence Officers, GSO2(I)s

Lt. Col. C.H. Mitchell	Sept. 1915 - Oct. 1916
Lt. Col. J.L.R. Parsons	Oct. 1916 - June 1917
Lt. Col. W.R. Bertram	June 1917 - Nov. 1917
Major T.M. McAvity	Nov. 1917 - Oct. 1918
Lt. Col. A.A. Magee	Oct. 1918 - 1919

¹ NAC, R.G. 24, Vol. 1886, Folder 82; Also S.R. Elliot, *Scarlet to Green. A History of Intelligence in the Canadian Army 1903 - 1963* (Toronto: Canadian Intelligence and Security Association, 1981), 595 - 596.

BIBLIOGRAPHY

Archival Sources:

Government Records:

National Archives of Canada. Record Group (R.G.) 9, Series II. Records of the Department of Militia and Defence. Post Confederation.

National Archives of Canada. R.G. 9, Series III. Records of the Department of Militia and Defence. Records of the Overseas Military Forces of Canada and the Canadian Expeditionary Force.

National Archives of Canada. R.G. 24. Records of the Department of National Defence.

Private Papers:

National Archives of Canada. Manuscript Group (M.G.) 30. Manuscripts of the First Half of the Twentieth Century. The following is a list of private papers consulted:

Adamson, Agar Stewart Allan Masterton. M.G. 30 E149.

Armstrong, Nevill Alex Drummond. M.G. 30 E2.

Bell, George. M.G. 30 E113.

Bovey, Wilfrid. M.G. 30 E5.

Brutinel, Raymond. M.G. 30 E414.

Burstall, Henry Edward. M.G. 30 E6.

Creelman, John Jennings. M.G. 30 E8.

Crerar, Henry Duncan Graham. M.G. 30 E157.

Currie, Arthur William. M.G. 30 E100.

Duggan, Ken. M.G. 30 E304.

Duguid, Archer Fortescue. M.G. 30 E12.

Erlebach, Cyril Woodland. M.G. 30 E40.

Griesbach, Willaim Androbus. M.G. 30 E15.
Gwatkin, Willoughby. M.G. 30 E51.
Hewgill, Willaim Herbert. M.G. 30 E16.
Hilliarn, Edward. M.G. 30 E239.
Jones, Elmer Watson. M.G. 30 E50.
Lamb, Henry John. M.G. 30 E68.
Leckie, John Edwards. M.G. 30 E83.
Leckie, Robert. M.G. 30 E84.
MacDonell, Archibald Cameron. M.G. 30 E20.
MacDonell, Archibald. M.G. 30 E399.
Macintyre, Duncan Eberts. M.G. 30 E241.
Magee, A.A. M.G. 30 E146.
Matthews, Harold Halford. M.G. 30 E60.
McDonald, Harold French. M.G. 30 E21.
McNaughton, Andrew. M.G. 30 E133.
Mitchell, Charles Hamilton. M.G. 30 E61.
Morgan, William Clement. M.G. 30 E488.
Morrison, Edward Whipple Bancroft. M.G. 30 E81.
O'Brien, William. M.G. 30 E389.
O'Brien, David Stephen. M.G. 30 E426.
Odlum, Victor Wentworth. M.G. 30 E300.
Panet, Edouard de Bellefeuille. M.G. 30 E229.
Parsons, Johnson Lindsay Rowlett. M.G. 30 E117.
Paull, Francis. M.G. 30 E450.
Peck, Cyrus Wesley. M.G. 30 E134.
Phelan, Frederick Ross. M.G. 30 E54.
Shrive, Frank J. M.G. 30 E233.

Sinclair, Alexander Gibson. M.G. 30 E237.

Sinclair, Ian MacIntosh. MG30E 432, N. A. C.

Turner, Richard Ernest William. M.G. 30 E46.

Urquhart, Hugh Macintyre. M.G. 30 E75.

Villiers, Paul Frederick. M.G. 30 E236.

Warden, John. M.G. 30 E192.

Watson, David. M.G. 30 E69.

*Published Sources:**Major Works:*

Adamson, Agar. *Letters of Agar Adamson 1914 to 1919. Lieutenant Colonel, Princess Patricia's Canadian Light Infantry.* Edited by N. M. Christie. Nepean, Ontario: CEF Books, 1997.

Andrew, Christopher. *Secret Service: The Making of the British Intelligence Community.* London: Sphere Books, 1984.

Ashworth, Tony. *Trench Warfare 1914 - 1918, The Live and Let Live System.* London: The Macmillan Press Ltd., 1980.

Aston, George, *Secret Service.* London: Faber & Faber Limited, [1930].

Bailey, J.B.A. *Field Artillery and Firpower.* New York: The Military Press, 1989.

Barnard, W. T. *The Queen's Own Rifles of Canada, 1860 - 1960; One Hundred Years of Canada.* Don Mills, Ont.: Ontario Publishing Co., 1960.

Barry, A.L. *Batman to Brigadier.* no publisher. no date.

Baylay, George Taylor, ed. *The Regimental History of the Governor General's Foot Guards.* Ottawa: Privately Printed, 1948.

Belton, James and E. G. Odell. *Hunting the Hun.* New York: D. Appleton & Company, 1918.

Bennett, S.G. *The 4th Canadian Mounted Rifles, 1914 - 1919.* Toronto: Murray Printing Company Limited, 1926.

Berton, Pierre. *Vimy.* McClelland and Stewart, 1986; reprint, Markham, Ontario: Penguin Books, 1987.

Bidwell, Shelford. *Gunners at War. A Tactical Study of the Royal Artillery in the Twentieth Century.* London: Arms and Armour Press, 1970.

---. *Modern Warfare. A Study of Men, Weapons and Theories.* London: Allen Lane of Penguin Books, 1973.

Bidwell, Shelford, and Dominick Graham. *Fire-Power. British Army Weapons and Theories of War 1904 - 1945.* London: George Allen & Unwin, 1982.

Bird, Will R. *Ghosts Have Warm Hands.* Toronto: Clarke, Irwin, 1968; reprint Nepean, Ontario: CEF Books, 1997.

---. *North Shore (New Brunswick) Regiment.* Fredericton, N.B.: Brunswick Press, 1963.

- Black, Ernest Garson. *I Want One Volunteer*. Toronto: Ryerson Press, [1965].
- Blaxland, Gregory. *Amiens: 1918*. London: Frederick Muller Ltd., 1968.
- Burns, E.L.M. *Memoirs of Two World War. General Mud*. Toronto: Clarke, Irwin & Company Limited, 1970.
- Bragg, Sir Lawrence, A.H. Dowson, and H.H. Hemming. *Artillery Survey in the First World War*. London: Field Survey Association, 1971.
- Calder, Donald George Scott. *The History of the 28th (Northwest) Battalion C.E.F. (October 1914 - June 1919); from the Memoirs of Brigadier-General Alexander Ross*. Regina, Sask: Privately Printed, 1961.
- Cassar, George. *Beyond Courage. The Canadians and the Second Battle of Ypres*. Ottawa: Oberon Press, 1985.
- Cecil, Hugh and Peter Liddle, eds. *Facing Armageddon: A Select Bibliography*. London: Leo Cooper, 1996.
- Charteris, John. *At GHQ*. London: Cassell and Company, Ltd., 1931.
- Chasseaud, Peter. *Trench Maps: A Collectors' Guide, Vol. 1. British Regular Series 1: 10,000 Trench Maps, GSGS 3062*. Lewis, East Sussex, 1986.
- Clayton, Anthony. *Forearmed, A History of the Intelligence Corps*. London: Brassey's (UK) Ltd., 1993.
- Cohen, Eliot and John Gooch. *Military Misfortunes. The Anatomy of Failure in War*. New York, Free Press, 1990; reprint, New York: Vintage Books, 1991.
- Cooper, Duff. *Haig*. Toronto: Macmillan Company of Canada Limited, 1936.
- Corrigall, D. J. *The History of the Twentieth Canadian Battalion (Central Ontario Regiment), Canadian Expeditionary Force in the Great War, 1914 - 1918*. Toronto: Stone & Cox Ltd., 1935.
- Crutwell, C. R. M. F. *A History of the Great War 1914 - 1918*. 1934. London: Granada Publishing Limited, 1982.
- Currie, J. A. *"The Red Watch"; With the First Canadian Division in Flanders*. Toronto: McClelland, Goodchild & Stewart, 1916.
- Dancocks, Daniel G. *Gallant Canadians; The Story of the Tenth Canadian Infantry Battalion, 1914 - 1919*. Calgary: The Calgary Highlanders Regimental Funds Foundation, 1990; reprint, Calgary: The Calgary Highlanders Regimental Funds Foundation, 1994.
- . *Legacy of Valour. The Canadians at Passchendaele*. Edmonton: Hurtig Publishers, 1986.

- . *Sir Arthur Currie. A Biography*. Toronto: Methuen, 1985.
- . *Spearhead to Victory. Canada and the Great War*. Edmonton: Hurting Publishers, 1987.
- . *Welcome to Flanders Fields*. Toronto: McClelland & Stewart Inc., 1989.
- Dawson, Coningsby. *The Glory of the Trenches; an Interpretation*. Toronto: S.B. Gundy, 1918.
- Deacon, Richard. *A History of British Secret Service*. revised edition. London: Panther/Granada Publishing, 1985.
- Dennis, Peter and Jeffrey Grey, eds., *1918: Defining Victory*. Canberra: Department of Defence, Army History Unit, 1999.
- Dewar, Michael. *The Art of Deception in Warfare*. New York: A David and Charles Military Book, 1989.
- Dixon, Norman. *On The Psychology of Military Incompetence*. Jonathan Cape Limited, 1976; reprint, London: Futura Publications, 1983.
- Duguid, A. F. *Official History of the Canadian Forces in the Great War, 1914 - 1919, Vol. 1*. Ottawa: Department of National Defence, 1938.
- . *Official History of the Canadian Forces in the Great War, 1914 - 1919, Appendices*. Ottawa: Department of National Defence, 1938.
- Dunn, S. C. *The War the Infantry Knew, 1914 - 19*. London: P. S. King, 1938.
- Eccles, Henry E. *Military Concepts and Philosophy*. New Brunswick, New Jersey: Rutgers University Press, 1965.
- Edmonds, James (general editor). *History of the Great War, Based on Official Documents: Military Operations, France and Belgium*. London: HMSO, 1920 - 1949.
- Elliot, S. R. *Scarlet to Green. A History of Intelligence in the Canadian Army 1903 - 1963*. Toronto: Canadian Intelligence and Security Association, 1981.
- Ellis, John. *Eye-Deep in Hell. Trench Warfare in World War I*. Pantheon Books, 1977; reprint, Baltimore: The John Hopkins University Press, 1989.
- . *Social History of the Machine Gun*. London: Croom Helm Ltd., 1976; reprint, London: Pimlico, 1993.
- Ellis, W. D., ed. *Saga of the Cyclists in the Great War, 1914 - 1918*. Toronto: Canadian Corps Cyclists Battalion Association, 1965.
- English, John A. *On Infantry*. New York: Praeger Books, 1981.
- Falls, Cyril. *The Great War*. Toronto: Longmans Canada Limited, 1961.

Fergusson, T. G. *British Military Intelligence, 1870 - 1914; The Development of a Modern Intelligence Organization*. Frederick, MD: University Publications of America Inc., 1984.

Ferris, John. ed. *The British Army and Signals Intelligence During the First World War*. Wolfeboro Falls, NH: Alan Sutton for the Army Records Society, 1992.

Fetherstonhaugh, F. C. *The 13th Battalion Royal Highlanders of Canada, 1914 1919*. Montreal: The Gazette Printing Co., Ltd., 1927.

---. *The Royal Montreal Regiment, 14th Battalion, C. E. F., 1914 - 1925*. Montreal: Privately Printed, 1925.

---. editor. *The 24th Battalion, C. E. F., Victoria Rifles of Canada 1914 - 1919*. Montreal: The Gazette Printing Co. Ltd., 1930.

Fetherstonhaugh, R. C. and G. R. Stevens. *The Royal Canadian Regiment, Vol I*. Montreal: Montreal Gazette Printing Company, 1936.

Fitz Gibbon, Constantine. *Secret Intelligence in the Twentieth Century*. London: Hart-Davis, MacGibbon, 1976.

Fraser, Donald. *The Journal of Private Fraser 1914 - 1918, Canadian Expeditionary Force*. Reginald H. Roy editor. Victoria: Sono Nis Press, 1985; reprint, Nepean Ontario: CEF Books, 1998.

French, David. *The British Way in Warfare*. London: Unwin Hyman, 1990.

Fuller, J. F. C. *A Military History of the Western World. Volume Three: From the American Civil War to the End of World War Two*. New York, 1957; reprint, New York: Da Capo Press, no date.

---. *Generalship: Its Diseases and Their Cure*. London: Faber and Faber, 1936.

---. *The Conduct of War, 1789 - 1961*. New Brunswick, NJ: Rutgers University Press, 1961; reprint, New York: Da Capo Press, 1992.

Gibson, W. I. comp. *Records of the Fourth Canadian Infantry Battalion in the Great War, 1914 - 1918*. Toronto: MacLean Publishing Company, 1924.

Goodspeed, D.J. *Battle Royal. A History of the Royal Regiment of Canada 1862 - 1962*. Toronto: The Royal Regiment of Canada Association, 1962.

---. *The Road Past Vimy: The Canadian Corps, 1914 - 1918*. Toronto: Macmillan, 1969.

Goodspeed, D.J. ed. *The Armed Forces of Canada 1867 - 1967*. Ottawa: The Directorate of History Canadian Forces Headquarters, 1967.

Griesbach, W. A. *I Remember*. Toronto: Ryerson Press, 1946.

Griffith, Paddy. *Battle Tactics of the Western Front, The British Army's Art of Attack, 1916 - 1918*. New Haven: Yale University Press, 1994.

---. *Forward Into Battle. Fighting Tactics From Waterloo to the Near Future*. Chichester, England: Anthony Bird Publications Ltd., 1981; revised edition, Novata, CA: Presidio Press, 1990.

Griffith, Paddy. ed. *British Fighting Methods in the Great War*. London: Frank Cass, 1996.

Gudgin, Peter. *Military Intelligence, The British Story*. London: Arms and Armour Press, 1989.

Gudmundsson, Bruce. *On Artillery*. Westport, CT.: Praeger Publishers, 1993.

---. *Stormtroop Tactics: Innovation in the German Army, 1914 - 1918*. New York: Praeger, 1989.

Hahn, J. E. *The Intelligence Service Within the Canadian Corps 1914 - 1918*. Toronto: The Macmillian Company of Canada Limited, 1930.

Handel, Michael. *Intelligence and Military Operations*. London: 1990.

---. *War, Strategy and Intelligence*. London: Frank Cass, 1989.

Harris, Stephen J. *Canadian Brass: The Making of a Professional Army, 1860 - 1939*. Toronto: University of Toronto Press, 1988.

Hart, B. H. Liddell.. *The Real War, 1914 - 1918*. Faber & Faber Ltd., 1930; reprinted as the *History of the First World War*, London: Papermac, 1992.

Hartcup, Guy. *The War of Invention: Scientific Development 1914 - 1918*. London: Brassey's Defence Publishers, 1988.

Haswell, Jock. *British Military Intelligence*. London: Weidenfeld and Nicolson, 1973.

Hayes, Joseph. *The Eighty-Fifth in France and Flanders*. Halifax: Royal Print and Litho Limited, 1920.

Henderson, David. *The Art of Reconnaissance*. 3rd edition. London: John Murray, 1914.

Hesketh - Prichard, H. *Sniping In France. How The British Army Won the Sniping War in the Trenches*. E.P Dutton and Company, no date; reprint Lancer Militaria, 1993.

Hodder-Williams, Ralph. *Princess Patricia's Canadin Light Infantry, 1914 - 1919*. Vol. 1. London and Toronto: Hodder & Stoughton, 1923.

Hogg, Ian. *Gas*. New York: Ballantine Books Inc., 1975.

---. *The Guns 1914 - 1918*. New York: Ballantine Books Inc., 1971.

Howard, Michael. *The Lessons of History*. New Haven: Yale University Press, 1991.

Hitchcock, F.C. *Stand To: A Diary of the Trenches, 1915-18*. 1937. Norwich, Norfolk: Glidden Books, 1988.

Hutchison, Paul. *Canada's Black Watch. The First Hundred Years 1862 - 1962*. Montreal: The Black Watch of Canada, 1962.

Hyatt, A. M. J. *General Sir Arthur Currie: A Military Biography*. Toronto: University of Toronto Press, 1987.

Innes, John A., Compiled by. *Flash Spotters and Sound Rangers: How They Lived, Worked and Fought in the Great War*. London: Allen & Unwin, 1935.

James, Fred. *Canada's Triumph. Amiens - September - October, 1918*. London: Charles & Son, [1918].

Johnson, Hubert C. *Break-Through! Tactics, Technology, and the Search for Victory on the Western Front in World War I*. Novato, CA.: Presidio Press, 1994.

Kerr, Wilfred Brenton. *Shrieks and Crashes, Being Memoirs of Canada's Corps, 1917*. Toronto: The Hunter Rose Co. Ltd., 1929.

Kerry, A. J. L. and W. A. McDill. *The History of the Corps of Royal Canadian Engineers: Vol. I, 1749 - 1939*. Ottawa: The Military Engineers Association of Canada, 1962.

Lang, W. R. *The Organization, Administration and Equipment of His Majesty's Land Forces in Peace and War*. Toronto: Copp Clark, 1916.

Lind, William S. *Manoeuvre Warfare Handbook*. Boulder Colo.: Westview Press, 1985.

Livesay, J. F. B. *Canada's Hundred Days; With the Canadian Corps from Amiens to Mons, Aug. 8 - Nov. 11, 1918*. Toronto: Thomas Allen, 1919.

MacDonald, J. A. ed. *Gun-Fire: An Historical Narrative of the 4th Bde. C. F. A. in the Great War (1914 - 18)*. Toronto: The 4th Brigade C.F.A. Association, 1929.

Macdonnel, Sir Archibald Cameron. *Final Order of the Day. The 1st Canadian Division in the Battles of 1918*. London: Barrs & Company, 1919.

Macintyre, D.E. *Canada at Vimy*. Toronto: Peter Martin Associates Ltd., 1967.

Macksey, Kenneth. *Vimy Ridge 1914 - 18*. New York: Ballantine Books, 1972.

Marteinson, John, et al. *We Stand on Guard. An Illustrated History of the Canadian Army.* Montreal: Ovale Publications, 1992.

McKean, G. B. *Scouting Thrills.* New York: The Macmillian Co., 1919.

McKee, Alexander. *Vimy Ridge.* Aberdeen: Souvenir Press, 1966.

McKenzie, F. A. *Through the Hindenburg Line: Crowning Days on the Western Front.* London: Hodder and Stoughton, 1918.

---. *Canada's Day of Glory.* Toronto: William Briggs, 1918.

McWilliams, J. and R. J. Steel. *Gas! The Battle for Ypres, 1915.* St. Catharines, Ontario: Vanwell Publishing Limited, 1985.

---. *The Suicide Battalion.* St. Catharines, Ontario: Vanwell Publishing Limited, 1990.

Mead, Peter. *The Eye in the Sky: History of Air Observation and Reconnaissance for the Army, 1785 - 1945.* London: Her Majesty's Stationary Office, 1983.

Messenger, Charles. *Trench Fighting 1914 - 1918.* New York: Ballantine Books, 1972.

Millett, Allan and Murray Williamson, editors. *Military Effectiveness. Vol. 1 The First World War.* Boston: Allen & UnWin, 1988.

Mitchell, Michael, comp. *Ducimus. The Regiments of the Canadian Infantry.* Ottawa: Canadian War Museum, 1992.

Moir, John, ed. *History of the Royal Canadian Corps of Signals, 1903 - 1961.* Ottawa: Corps Committee Royal Canadian Corps of Signals, 1962.

Morris, David A. *The Canadian Militia, from 1855; an Historical Summary.* Erin, Ont.: Boston Mills Press, 1983.

Morton, Desmond. *A Military History of Canada. From Champlain to the Gulf War.* Toronto: McClelland & Stewart Inc., 1992.

---. *Canada and War.* Toronto: Butterworth & Co. (Canada) Ltd., 1981.

---. *When Your Number is Up. The Canadian Soldier in the First World War.* Toronto: Random House of Canada Ltd., 1993.

Morton, Desmond, J. L. Granatstein. *Marching to Armageddon. Canadians and the Great War 1914 - 1918.* Toronto: Lester & Orpen Dennys, 1989.

Murray, W. W. *Five Nines and Whiz Bangs.* Ottawa: Perrault Printing Company, 1937.

---. *The History of the 2nd Canadian Battalion (Eastern Ontario Regiment) Canadian Expeditionary Force in the Great War, 1914 - 1918*. Ottawa: Mortimer Ltd., 1947.

Nalder, R. F. H. *The Royal Corps of Signals: A History of Its Antecedents and Development (Circa 1800 - 1953)*. London: 1958.

Neilson, Keith and B. J. C. McKercher ed. *Go Spy the Land. Military Intelligence in History*. Westport Ct.: Praeger, 1992.

Nicholls, Jonathan. *Cheerful Sacrifice. The Battle of Arras 1917*. London: Leo Cooper, 1990.

Nicholson, G. W. L. *The Official History of the Canadian Army in the First World War: Canadian Expeditionary Force, 1914 - 1919*. Ottawa: Queen's Printer, 1962.

---. *The Gunners of Canada; the History of the Royal Regiment of Canadian Artillery. Vol 1. 1534 - 1919*. Toronto: McClelland & Stewart Ltd., 1967.

Occelshaw, Michael. *Armour Against Fate. British Military Intelligence in the First World War*. London: Columbus Books Limited, 1989.

Parritt, B. A. H. *The Intelligencers: The History of British Military Intelligence Up To 1914*. 1971. Second edition, Ashford, Kent, UK: Intelligence Corps Association, 1983.

Pemberton, A. L. *The Development of Artillery Tactics and Equipment*. London: War Office, 1950.

Prior, Robin and Trevor Wilson. *Command on the Western Front: The Military Career of Sir Henry Rawlinson, 1914 - 1918*. Oxford: Blackwell Publishers, 1992.

---. *Passchendaele. The Untold Story*. New Haven and London: Yale University Press, 1996.

Rawling, Bill. *Surviving Trench Warfare. Technology and the Canadian Corps, 1914 - 1918*. Toronto: University of Toronto Press, 1992.

Reid, Gordon. *Poor Bloody Murder: Personal Memoirs of the First World War*. Oakville: Mosaic Press, 1980.

Russenholt, E. S. comp. *Six Thousand Canadian Men; Being the History of the 44th Battalion Canadian Infantry, 1914 - 1919*. Winnipeg: Privately Printed, 1932.

Samuels, Martin. *Command or Control? Command, Training and Tactics in the British and German Armies, 1888 - 1918*. London: Frank Cass, 1995.

Sassoon, Siegfried. *Memoirs of an Infantry Officer*. 1930; reprint, London: Faber, 1965.

Schreiber, Shane. *Shock Army of the British Empire. The Canadian Corps in the Last 100 Days of the Great War*. Westport CT: Praeger, 1997.

Schwein, E. E. *Combat Intelligence: Its Acquisition and Transmission*. Washington: The Infantry Journal, 1936.

Scudamore, T.V. *A Short History of the 7th Battalion, CEF*. Vancouver: Anderson and Odium Ltd., 1930.

Seymour, W. A., ed. *A History of the Ordnance Survey*. Folkstone, Kent: William Dawson & Son Ltd., 1980.

Sheffy, Yigal. *British Military Intelligence in the Palestine Campaign 1914 - 1918*. London: Frank Cass, 1998.

Sheldon-Williams, Ralf Frederic Lardy and Inglis Sheldon-Williams. *The Canadian Front in France and Flanders*. London: A. and C. Black Ltd., 1920.

Singer, H. C. and A. A. Peebles. *History of Thirty-First Battalion C. E. F. From its Organization, November, 1914, to its Demobilization, June, 1919*. Calgary: Privately Printed, 1939.

Sixsmith, E. K. G. *British Generalship in the Twentieth Century*. London: Arms and Armour Press, 1970.

Smyth, Sir John. *Leadership in Battle 1914 - 1918, Commanders in Action*. New York: Hippocrene Books Inc., 1975.

Spears, Sir Edward. *Liaison 1914. A Narrative of the Great Retreat*. Second Edition. 1930; reprint, London: Eyre & Spottiswoode, 1968.

Strong, Sir Kenneth. *Men of Intelligence. A Study of the Roles and Decision of Chiefs of Intelligence From World War I to the Present Day*. London: Cassell & Company Ltd., 1970.

Swettenham, J. A. *Canada and the First World War*. Ottawa: Canadian War Museum, 1969.

---. *Breaking the Hindenburg Line*. Canadian War Museum Battle Series, Ottawa: Balmuir Book Publishing Ltd., 1986.

---. *To Seize the Victory: The Canadian Corps in World War I*. Toronto: Ryerson Press, 1965.

---. *McNaughton, Vol. 1, 1887 - 1939*. Toronto: Ryerson Press, 1968.

Terraine, John. *The First World War 1914 - 1918*. Macmillan (USA) and Hutchinson & Co. (Publishers), 1965; reprint, London: Papermac, 1984.

---. *The Road to Passchendaele, The Flanders Offensive of 1917: A Study in Inevitability*. London: Leo Cooper, 1977.

---. *The Smoke and the Fire: Myths and Anti Myths of War 1861 - 1945*. London: Sidgwick & Jackson, 1980.

---. *To Win a War. 1918, The Year of Victory*. United Kingdom: Sidgwick and Jackson Limited, 1978; reprint, London: Papermac, 1986.

---. *White Heat. The New Warfare, 1914 - 1918*. London: Sidgwick and Jackson, 1982.

Travers, Tim. *How the War Was Won: Command & Technology in the British Army on the Western Front, 1917 - 1918*. London: Routledge, 1992.

---. *The Killing Ground. The British Army, the Western Front and the Emergence of Modern Warfare, 1900 - 1918*. London: Allen and Unwin, 1987.

Tuohy, F. *The Battle of Brains*. London: William Heinemann Ltd., 1930.

---. *The Crater of Mars*. London: William Heinemann Ltd., 1929.

---. *The Secret Corps. A Tale of Intelligence on all Fronts*. London: John Murray, 1920.

Urquhart, Hugh. *Arthur Currie: The Biography of a Great Canadian*. Toronto: J.M. Dent & Sons (Canada) Limited, 1950.

---. *The History of the 16th Battalion (The Canadian Scottish) Canadian Expeditionary Force in the Great War 1914 - 1919*. Toronto: Macmillan, 1932.

Van Creveld, Martin. *Command in War*. Cambridge: Harvard University Press, 1985.

Wade, Aubrey. *The War of the Guns: Western Front 1917 - 1918*. London: B.T. Batsford Ltd., 1936.

---. *Gunner on the Western Front*. 1936. London: B.T. Batsford Ltd., 1959.

Watson, Sir David. *The Story of the Fourth Canadian Division 1916 - 1919*. Aldershot: Gale & Polden Ltd., [1919].

Williams, Jeffery. *Byng of Vimy. General and Governor General*. Leo Cooper, 1983; reprint, Toronto: University of Toronto Press, 1992.

---. *Princess Patricia's Canadian Light Infantry*. London: Leo Cooper, 1972.

Winter, Denis. *Death's Men. Soldiers of the Great War.* Allen Lane, 1978; reprint, Toronto: Penguin Books, 1979.

---. *Haig's Command. A Reassessment.* Viking, 1991; reprint, Toronto: Penguin Books, 1992.

Wise, S. F. *Canadian Airmen and the First World War. The Official History of the Royal Canadian Air Force Vol. 1.* Toronto: University of Toronto Press in cooperation with the Dept. of National Defence and the Canadian Government Pub. Centre, Supply and Services, 1980.

Wood, Eric Fisher. *The Note-book of an Intelligence Officer.* Toronto: George J. McLeod Ltd., 1917.

Wood, Herbert Fairlie. *Vimy.* Toronto: Macmillan of Canada, 1967.

Worthington, Larry. *Amid the Guns Below: The Story of the Canadian Corps (1914 - 1919).* Toronto: McClelland & Stewart Ltd., 1965.

Zabecki, David. *Steel Wind. Colonel Georg Bruchmüller and the Birth of Modern Artillery.* Westport, CT.: Praeger, 1994.

Articles:

Anderson, Sir W. H. "The Crossing of the Canal du Nord by the First Army, 27th September, 1918." *Canadian Defence Quarterly* 2.1 (October 1924): 63 - 77.

---. "The Operation Round Valenciennes by the First Army, October - November 1918." *Canadian Defence Quarterly* 2.3 (April 1925): 289 - 303.

---. "The Breaking of the Quéant-Drocourt Line by the Canadian Corps, First Army, 2nd - 4th September, 1918." *Canadian Defence Quarterly* 3.2 (January 1926): 120 - 127.

Andrew, Christopher. "The Mobilization of British Intelligence for the Two World Wars." In *Mobilization for Total War. The Canadian, American and British Experience 1914 - 1918, 1939 - 1945*, 87 - 110. Waterloo, Ontario: Wilfrid Laurier University Press, 1981.

Bailes, Howard. "Patterns of Thought in the Late Victorian Army." *Journal of Strategic Studies* 4.1: 29 - 45.

Betts, Richard K. "Analysis, War and Decision: Why Intelligence Failures are Inevitable." *World Politics* 31 (October, 1978): 61 - 89.

Boire, Michael. "The Underground War: Military Mining Operations in Support of the Attack on Vimy Ridge, 9 April 1917." *Canadian Military History* 1.1 & 2 (1992): 15 - 24.

Bond, Brian. "Doctrine and Training in the British Cavalry, 1870 - 1914." *The Theory and Practice of War*, ed. Michael Howard, 95 - 125. London: Cassell & Company Ltd., 1965.

Broad, C.N.F. "The Development of Artillery Tactics 1914 - 1918." *Journal of the Royal Artillery* 49.2 (1922 - 23): 62 - 81; 49.3 (1922 - 23): 127 - 148.

---. "Artillery Intelligence and Counter Battery Work." *Journal of the Royal Artillery* 49.4 (1922 - 23): 187 - 198; 49.5 (1922 - 23): 221 - 242.

Brooke, A.F. "The Evolution of Artillery in the Great War." *Journal of the Royal Artillery* 51.5 (1924): 250 - 267; 51.6 (January 1925): 359 - 372; 52.1 (April 1925): 37 - 51; 52.3 (October 1925): 369 - 387; 53.1 (April 1926): 76 - 93; 53.2 (July 1926): 233 - 249; 53.3 (October 1926): 320 - 329; 53.4 (January 1927): 469 - 482.

Brown, Ian M. "Not Glamorous But Effective: The Canadian Corps and the Set-piece Attack, 1917 - 1918." *The Journal of Military History* 58.3 (July 1994): 421 - 444.

Budworth, C.E.D. "Training and Action Necessary to Further Co-operation Between Artillery and Infantry." *Journal of the Royal United Services Institute* (January 1913): 67 - 86.

Chappelle, Dean. "The Canadian Attack at Amiens 8 - 11 August 1918." *Canadian Military History* 2.2 (Autumn, 1993): 89 - 101.

Chasseaud, Peter. "Trench Mapping: Military Survey and Large-Scale Mapping on the Western Front 1914 - 18: British Experience and Practice." *Stand-To* 21 (1987): 29 - 33 and 22 (1988): 6 - 9.

Cook, Tim. "The Blind Leading the Blind. The Battle of the St. Eloi Craters." *Canadian Military History* 5.2 (Autumn 1996): 24 - 36.

Currie, Sir Arthur. "Canadian Corps Operations during the Year 1918; Interim Report." In *Report of the Ministry, Overseas Military Forces of Canada, 1918* Ottawa: King's Printer, 1919.

Cusins, A.G.T. "Development of Army Wireless During the War." *Journal of the Institute of Electrical Engineers* 59 (July 1921): 763 - 776.

De Groot, Gerard J. "Sir Douglas Haig's Faith Was So Blind, He Ignored Devastating Fact...As Perhaps Was Necessary." *Military History* (August 1994): 74 - 79.

Duguid, A. F. "Canadians in Battle, 1915 - 1918." *Canadian Historical Association* (1935): 36 - 50.

English, John. A. "Great War 1914 - 18: The 'Riddle of the Trenches'". *Canadian Defence Quarterly* 15.2 (Autumn 1985): 41 - 47.

Ferris, John and Michael Handel. "Clausewitz, Intelligence, Uncertainty and the Art of Command in Military Operations." *Intelligence and National Security* 10.1 (January 1995): 1 - 58.

Ferris, John. "Before 'Room 40': The British Empire and Signals Intelligence, 1898 - 1914." *Journal of Strategic Studies* 12.4 (Dec. 1989): 431 - 457.

---. "The British Army and Signals Intelligence in the Field During the First World War." *Intelligence and National Security* 3.3 (Oct. 1988): 23 - 48.

French, David. "Sir John French's Secret Service on the Western Front, 1914 - 1915." *The Journal of Strategic Studies* 7.4 (Dec. 1984): 423 - 440.

---. "The Meaning of Attrition, 1914 - 16." *English Historical Review* (April 1988): 385 - 405.

Goodspeed, D. J. "Prelude to the Somme: Mount Sorrel, June, 1916." In *Policy by Other Means. Essays in Honour of C.P. Stacey*, ed. Michael Cross and Robert Bothwell, 147 - 161. Toronto: Clarke Irwin & Co. Ltd., 1972.

Graham, Dominick. "'Sans Doctrine': British Army Tactics in the First World War." In *Men at War. Politics, Technology and Innovation in the Twentieth Century*, ed. Tim Travers and Christon Archer, 69 - 91. Chicago: Precedent, 1982.

---. "The British Expeditionary Force in 1914 and the Machine Gun." *Military Affairs* 46.4 (Dec. 1982): 190 - 193.

Greenhouse, Brereton. "The Canadian Cavalry Brigade at Moreuil Wood, 30 March 1918." *Canadian Defence Quarterly* (Spring 1988): 40 - 47.

---. "It Was Chiefly a Canadian Battle: The Decision at Amiens, 8 - 11 August 1918." *Canadian Defence Quarterly* (Autumn 1988): 73 - 80.

Handel, Michael. "Intelligence and the Problem of Strategic Surprise." *Journal of Strategic Studies* 7.3 (Sept. 1984): 229 - 281.

Hinks, Arthur R. "German War Maps and Survey." *The Geographical Journal* 53.1 (January 1919): 30 - 44.

Hooker, C.E. "Signals Intelligence." *Canadian Defence Quarterly* (October 1989): 50 - 59.

House, Jonathan. "The Decisive Attack: A New Look at French Infantry Tactics on the Eve of World War One." *Military Affairs* 40.4 (Dec. 1976): 164 - 168.

Hyatt, A. M. J. "Canadian Generals in the First World War and the Popular View of Military Leadership." *Social History* (November 1979): 418 - 430.

Jeffery, Keith. "Intelligence and Military History: A British Perspective." In *Military History and the Military Profession*, ed. David A. Charters, Marc Milner and J. Brent Wilson, 105 - 118. Westport, CT.: Praeger, 1992.

Jenkins, Dan. "The Corps of Guides, 1903 - 1914." *Canadian Military History* 5.2 (Autumn 1996): 88 - 98.

Kirke, R.M. St. G. "Some Aspects of Artillery Development During the First World War on the Western Front." *Journal of the Royal Artillery* 101 (September 1974): 130 - 40.

Leppard, Thomas. "'The Dashing Subaltern.' Sir Richard Turner in Retrospect." *Canadian Military History* 6.2 (Autumn 1997): 21 - 28.

Lloyd, H.A. "Classification of the Ground From the Air." *The Geographical Journal* 56.2 (August 1920): 99 - 107.

Luvaas, Jay. "European Military Thought and Doctrine, 1870 - 1914." *The Theory and Practice of War*, ed. Michael Howard, 69 - 94. London: Cassell & Company Ltd., 1965.

Macdonnel, A.C. "The Old Red Patch at the Breaking of the Drocourt-Quéant Line, the Crossing of the Canal du Nord and the Advance on Cambrai, 30th Aug. - 2nd Oct., 1918." *Canadian Defence Quarterly* 4 (July 1927): 388 - 396.

---. "'The Old Red Patch.' The 1st Division at the Breaking of the Canal du Nord Line." *Canadian Defence Quarterly* 9.1 (October 1931): 10 - 26.

Macintyre, D.E. "The Vimy Sector In War and Peace." *The Legionary* 14.9 (April 1939): 1 - 6, 30.

MacLeod, M.N. "Mapping From Air Photographs." *The Geographical Journal* 53.6 (June 1919): 382 - 403.

Madden, Robert. "The Myth of Destruction: Artillery in the Great War." *Field Artillery* (August 1994): 44 - 47.

McCulloch, Ian. "'Batty Mac:' Portrait of a Brigade Commander of the Great War, 1915 - 1917." *Canadian Military History* 7.4 (Autumn 1998): 11 - 28.

McDermott, John. "The Revolution in British Military Thinking From the Boer War to the Moroccan Crisis." *Canadian Journal of History* 9.2 (Aug 1974): 159 - 177.

McNaughton, A. G. L. "The Capture of Valenciennes: A Study in Co-ordination." *Canadian Defence Quarterly* 10.3 (April 1933): 279 - 294.

---. "Counter Battery Work." *Canadian Defence Quarterly* 3.4 (July, 1926): 380 - 391.

---. "The Development of Artillery in the Great War." *Canadian Defence Quarterly* (Jan. 1929): 160 - 171.

Miller, Carman. "Sir Frederick William Borden and Military Reform, 1896 - 1911." *The Canadian Historical Review* 50.3 (September 1969): 265 - 284.

Morgan, William A. "Invasion on the Ether: Radio Intelligence at the Battle of St. Mihiel, September 1918." *Military Affairs* 51.2 (April 1987): 57 - 61.

Murray, Jeffrey S. "British - Canadian Military Cartography on the Western Front, 1914 - 1918." *Archivaria* 26 (Summer 1988): 52 - 65.

---. "Mapping the Western Front." *Military History* 6.5 (April 1990): 10 - 14, 18 - 20.

Paine, George H. "Accurate Shooting in Trench Warfare." *The Field Artillery Journal* 7 (1917): 440 - 453.

Palazzo, Albert P. "The British Army's Counter-Battery Staff Office and Control of the Enemy in World War I." *The Journal of Military History* 63.1 (January 1999): 55- 74.

Penrose, John. "Survey for Batteries." *Journal of the Royal Artillery* 49 (1922 - 23): 253 - 270.

Rawling, Bill. "Communications in the Canadian Corps, 1915 - 1918: Wartime Technological Progress Revisited." *Canadian Military History* 3.2 (Autumn 1994): 6 - 21.

---. "Tunnellers on the Western Front, 1914 - 1918." *Canadian Defence Quarterly* (July 1993): 37 - 42.

---. "Technology in Search of a Role. The Machine Gun and the Canadian Expeditionary Force in the First World War." *Material History Review* 42 (Fall 1995): 87 - 100.

Robbins, Simon. "The Right Way to Play the Game: The Ethos of the British High Command in the First World War." *Imperial War Museum Review* 6 (1991): 39 - 50.

Roy, R. H. "The Battle for Courcelette, September, 1916: A Soldier's View." *Journal of Canadian Studies* 16.3 & 4 (Autumn - Winter 1981 - 2): 56 - 67.

---. "The Canadian Military Tradition." In *The Canadian Military. A Profile*, ed. Hector J. Massey, 6 - 48. Copp Clark Publishing Company, 1972.

---. "Vimy Ridge -- A View From the Ranks." *Canadian Defence Quarterly* 13.2 (Autumn 1983): 35 - 41.

Samuels, Martin. "British Tactical Experiments in 1915." *British Army Review* 105 (December 1993): 63 - 71.

Sinnott, John P. "It Was Algerian and Canadian Soldiers at Ypres Who Suffered History's First Major Poison Gas Attack." *Military History* (April 1994): 12 - 16, 81.

Snell, J. M. "Vimy Ridge 1917: A Canadian Easter." *Army Quarterly and Defence Journal* 123 (October, 1993): 430 - 437.

Stacey, C.P. "The Staff Officer: A Footnote to Canadian Military History." *Canadian Defence Quarterly* (August 1990): 21 - 28.

Stanley, George. "Military Education in Canada, 1867 - 1970." In *The Canadian Military. A Profile*, ed. Hector J. Massey, 169 - 196. Copp Clark Publishing Company, 1972.

Steel, W. A. "Wireless Telegraphy in the Canadian Corps in France." *Canadian Defence Quarterly* 6.4 (July 1929): 443 - 461; 7.1 (Oct. 1929): 45 - 52; 7.3 (April 1930): 365 - 375; 7.4 (July 1930): 458 - 467; 8.1 (Oct. 1930): 84 - 93; 8.3 (April 1931): 387 - 398; 8.4 (July 1931): 536 - 546; 9.1 (Oct. 1931): 105 - 116.

Travers, T.H.E. "A Particular Style of Command: Haig and GHQ, 1916 - 1918." *Journal of Strategic Studies* 10.3 (Sept. 1987): 363 - 376.

---. "Allies in Conflict: The British and Canadian Official Historians and the Real Story of Second Ypres (1915)." *Journal of Contemporary History* 24 (1989): 301 - 325.

---. "Command and Leadership Styles in the British Army: The 1915 Gallipoli Model." *Journal of Contemporary History* 29 (1994): 403 - 402.

---. "Could the Tanks of 1918 Have Been War-Winners for the British Expeditionary Force?" *Journal of Contemporary History* 27 (1992): 389 - 406.

---. "The Development of British Military Historical Writing and Thought from the Eighteenth Century to the Present." In *Military History and the Military Profession*, ed. David A. Charters, Marc Milner, and J. Brent Wilson, 23 - 44. Westport, CT.: Praeger, 1992.

---. "The Evolution of British Strategy and Tactics on the Western Front in 1918: GHQ, Manpower, and Technology." *The Journal of Military History* 54 (April 1990): 173 - 200.

---. "The Hidden Army: Structural Problems in the British Officer Corps, 1900 - 1918." *Journal of Contemporary History* 17.3 (1982): 523 - 544.

---. "Learning and Decision-making on the Western Front, 1915 - 1916: The British Example." *Canadian Journal of History* 18.1 (April 1983): 87 - 98.

---. "Technology, Tactics, and Morale: Jean de Bloch, the Boer War, and British Military Theory 1900 - 1914." *Journal of Modern History* 51.2 (June 1979): 264 - 286.

---. "The Offensive and the Problem of Innovation in British Military Thought 1870 - 1915." *Journal of Contemporary History* 13 (1978): 531 - 553.

Trumpener, Ulrich. "The Road to Ypres: The Beginnings of Gas Warfare in World War I." *Journal of Modern History* 47.3 (Sept. 1975): 460 - 480.

Winterbotham, H. "British Survey on the Western Front." *The Geographical Journal* 53.4 (April 1919): 253 - 276.

---. "Geographical and Survey Work in France, Especially in Connection With Artillery." *Journal of the Royal Artillery* 46 (1919): 154 - 172.

---. "Geographical Work With the Army in France." *The Geographical Journal* 54.1 (1919): 12 - 28.

Wise, S.F. "The Black Day of the German Army: Canadians and Australians at Amiens, August 1918." In *1918: Defining Victory*, eds. Peter Dennis and Jeffrey Grey, 1 - 32. Canberra: Department of Defence, Army History Unit, 1999.

---. "The Borden Government and the Formation of a Canadian Flying Corps, 1911 - 1916." In *Policy by Other Means. Essays in Honour of C.P. Stacey*, eds. Michael Cross and Robert Bothwell, 121 - 144. Toronto: Clarke Irwin & Co. Ltd., 1972.

Wynne, G. C. "The Development of the German Defensive Battle in 1917 and its Influence on British Defensive Tactics." *The Army Quarterly* 34 (April 1937): 15 - 34.

*Unpublished Secondary Sources:**Theses:*

Bezeau, M. V. "The Role and Organization of Canadian Militia Staffs 1904 - 1945." Master's Thesis, Royal Military College, 1978.

Brown, Ian. "Currie and the Canadian Corps 1917 - 1918." Master's Thesis, University of Calgary, 1991.

Cooke, Owen Arnold. "Organization and Training in the Central Canadian Militia 1866 - 1885." Master's Thesis, Queen's University, 1974.

Eyre, Kenneth C. "Staff and Command in the Canadian Corps. The Canadian Militia 1896 - 1914 as a Source of Senior Officers." Master's Thesis, Duke University, 1967.

Harris, Stephen Mark. "British Military Intelligence in the Crimean War, 1854 - 1856." Master's Thesis, University of Calgary, 1993.

Hyatt, A. "The Military Career of Sir Arthur Currie." Ph.D. dissertation, Duke University, 1964.

Leppard, Thomas Philp. "Richard Turner and the Battle of St. Eloi." Master's Thesis, University of Calgary, 1994.

Losinger, Isabella Diane. "Officer - Man Relations in the Canadian Expeditionary Force, 1914 - 1919." Master's Thesis, Carleton University, 1990.

Mowbray, James Arthur. "Militiaman: A Comparative Study of the Evolution of Organization in the Canadian and British Volunteer Citizen Military Forces, 1896 - 1939." Ph.D dissertation, Duke University, 1975.

Stewart, William. "Attack Doctrine in the Canadian Corps, 1916 - 18." Master's Thesis, University of New Brunswick, 1982.